

# MATHEMATICS

*Textbook for Class X*



1062



एन सी ई आर टी  
NCERT

राष्ट्रीय शैक्षिक अनुसंधान और प्रशिक्षण परिषद्  
NATIONAL COUNCIL OF EDUCATIONAL RESEARCH AND TRAINING

ISBN 81-7450-634-9

**First Edition**

December 2006 Pausa 1928

**Reprinted**

October 2007 Kartika 1929  
January 2009 Pausa 1930  
December 2009 Agrahayana 1931  
November 2010 Kartika 1932  
January 2012 Pausa 1933  
November 2012 Kartika 1934  
November 2013 Kartika 1935  
November 2014 Agrahayana 1936  
December 2015 Agrahayana 1937  
December 2016 Pausa 1938  
December 2017 Pausa 1939  
January 2019 Pausa 1940

**PD 700T BS**

© National Council of Educational  
Research and Training, 2006

₹ 160.00

Printed on 80 GSM paper with  
NCERT watermark

Published at the Publication Division by  
the Secretary, National Council of  
Educational Research and Training,  
Sri Aurobindo Marg, New Delhi 110 016  
and printed at S.P.A. Printers (P.) Ltd.,  
B 17/3, Okhla Industrial Area, Phase-II,  
New Delhi - 110 020

**ALL RIGHTS RESERVED**

- ❑ No part of this publication may be reproduced, stored in a retrieval system or transmitted, in any form or by any means, electronic, mechanical, photocopying, recording or otherwise without the prior permission of the publisher.
- ❑ This book is sold subject to the condition that it shall not, by way of trade, be lent, re-sold, hired out or otherwise disposed of without the publisher's consent, in any form of binding or cover other than that in which it is published.
- ❑ The correct price of this publication is the price printed on this page. Any revised price indicated by a rubber stamp or by a sticker or by any other means is incorrect and should be unacceptable.

**OFFICES OF THE PUBLICATION DIVISION, NCERT**

NCERT Campus  
Sri Aurobindo Marg  
New Delhi 110 016 Phone : 011-26562708

108, 100 Feet Road  
Hosdakere Halli Extension  
Banashankari III Stage  
Bengaluru 560 085 Phone : 080-26725740

Navjivan Trust Building  
P.O.Navjivan  
Ahmedabad 380 014 Phone : 079-27541446

CWC Campus  
Opp. Dhankal Bus Stop  
Panihati  
Kolkata 700 114 Phone : 033-25530454

CWC Complex  
Maligaon  
Guwahati 781 021 Phone : 0361-2674869

**Publication Team**

Head, Publication : M. Siraj Anwar  
Division  
Chief Editor : Shveta Uppal  
Chief Business : Gautam Ganguly  
Manager  
Chief Production : Arun Chitkara  
Officer  
Editor : Bijnan Sutar  
Production Assistant : Om Prakash

**Illustrations**

Joel Gill and Arvinder Chawla

**Cover**

Arvinder Chawla

## Foreword

The National Curriculum Framework, 2005, recommends that children's life at school must be linked to their life outside the school. This principle marks a departure from the legacy of bookish learning which continues to shape our system and causes a gap between the school, home and community. The syllabi and textbooks developed on the basis of NCF signify an attempt to implement this basic idea. They also attempt to discourage rote learning and the maintenance of sharp boundaries between different subject areas. We hope these measures will take us significantly further in the direction of a child-centred system of education outlined in the National Policy on Education (1986).

The success of this effort depends on the steps that school principals and teachers will take to encourage children to reflect on their own learning and to pursue imaginative activities and questions. We must recognise that, given space, time and freedom, children generate new knowledge by engaging with the information passed on to them by adults. Treating the prescribed textbook as the sole basis of examination is one of the key reasons why other resources and sites of learning are ignored. Inculcating creativity and initiative is possible if we perceive and treat children as participants in learning, not as receivers of a fixed body of knowledge.

These aims imply considerable change in school routines and mode of functioning. Flexibility in the daily time-table is as necessary as rigour in implementing the annual calendar so that the required number of teaching days are actually devoted to teaching. The methods used for teaching and evaluation will also determine how effective this textbook proves for making children's life at school a happy experience, rather than a source of stress or boredom. Syllabus designers have tried to address the problem of curricular burden by restructuring and reorienting knowledge at different stages with greater consideration for child psychology and the time available for teaching. The textbook attempts to enhance this endeavour by giving higher priority and space to opportunities for contemplation and wondering, discussion in small groups, and activities requiring hands-on experience.

The National Council of Educational Research and Training (NCERT) appreciates the hard work done by the textbook development committee responsible for this book. We wish to thank the Chairperson of the advisory group in Science and Mathematics, Professor J.V. Narlikar and the Chief Advisors for this book, Professor P. Sinclair of IGNOU, New Delhi and Professor G.P. Dikshit (Retd.) of Lucknow University, Lucknow for guiding the work of this committee. Several teachers

contributed to the development of this textbook; we are grateful to their principals for making this possible. We are indebted to the institutions and organisations which have generously permitted us to draw upon their resources, material and personnel. We are especially grateful to the members of the National Monitoring Committee, appointed by the Department of Secondary and Higher Education, Ministry of Human Resource Development under the Chairpersonship of Professor Mrinal Miri and Professor G.P. Deshpande, for their valuable time and contribution. As an organisation committed to systemic reform and continuous improvement in the quality of its products, NCERT welcomes comments and suggestions which will enable us to undertake further revision and refinement.

New Delhi  
15 November 2006

*Director*  
National Council of Educational  
Research and Training

## Preface

Through the years, from the time of the Kothari Commission, there have been several committees looking at ways of making the school curriculum meaningful and enjoyable for the learners. Based on the understanding developed over the years, a National Curriculum Framework (NCF) was finalised in 2005. As part of this exercise, a National Focus Group on Teaching of Mathematics was formed. Its report, which came in 2005, highlighted a constructivist approach to the teaching and learning of mathematics.

The essence of this approach is that children already know, and do some mathematics very naturally in their surroundings, before they even join school. The syllabus, teaching approach, textbooks etc., should build on this knowledge in a way that allows children to enjoy mathematics, and to realise that mathematics is more about a way of reasoning than about mechanically applying formulae and algorithms. The students and teachers need to perceive mathematics as something natural and linked to the world around us. While teaching mathematics, the focus should be on helping children to develop the ability to particularise and generalise, to solve and pose meaningful problems, to look for patterns and relationships, and to apply the logical thinking behind mathematical proof. And, all this in an environment that the children relate to, without overloading them.

This is the philosophy with which the mathematics syllabus from Class I to Class XII was developed, and which the textbook development committee has tried to realise in the present textbook. More specifically, while creating the textbook, the following broad guidelines have been kept in mind.

- The matter needs to be linked to what the child has studied before, and to her experiences.
- The language used in the book, including that for ‘word problems’, must be clear, simple and unambiguous.
- Concepts/processes should be introduced through situations from the children’s environment.
- For each concept/process give several examples and exercises, but not of the same kind. This ensures that the children use the concept/process again and again, but in varying contexts. Here ‘several’ should be within reason, not overloading the child.
- Encourage the children to see, and come out with, diverse solutions to problems.

- As far as possible, give the children motivation for results used.
- All proofs need to be given in a non-didactic manner, allowing the learner to see the flow of reason. The focus should be on proofs where a short and clear argument reinforces mathematical thinking and reasoning.
- Whenever possible, more than one proof is to be given.
- Proofs and solutions need to be used as vehicles for helping the learner develop a clear and logical way of expressing her arguments.
- All geometric constructions should be accompanied by an analysis of the construction and a proof for the steps taken to do the required construction. Accordingly, the children would be trained to do the same while doing constructions.
- Add such small anecdotes, pictures, cartoons and historical remarks at several places which the children would find interesting.
- Include optional exercises for the more interested learners. These would not be tested in the examinations.
- Give answers to all exercises, and solutions/hints for those that the children may require.
- Whenever possible, propagate constitutional values.

As you will see while studying this textbook, these points have been kept in mind by the Textbook Development Committee. The book has particularly been created with the view to giving children space to explore mathematics and develop the abilities to reason mathematically. Further, two special appendices have been given — Proofs in Mathematics, and Mathematical Modelling. These are placed in the book for interested students to study, and are only optional reading at present. These topics may be considered for inclusion in the main syllabi in due course of time.

As in the past, this textbook is also a team effort. However, what is unusual about the team this time is that teachers from different kinds of schools have been an integral part at each stage of the development. We are also assuming that teachers will contribute continuously to the process in the classroom by formulating examples and exercises contextually suited to the children in their particular classrooms. Finally, we hope that teachers and learners would send comments for improving the textbook to the NCERT.

PARVIN SINCLAIR  
G.P. DIKSHIT  
*Chief Advisors*  
Textbook Development Committee

## Textbook Development Committee

### CHAIRPERSON, ADVISORY GROUP IN SCIENCE AND MATHEMATICS

J.V. Narlikar, *Emeritus Professor*, Inter-University Centre for Astronomy & Astrophysics (IUCAA), Ganeshkhind, Pune University, Pune

### CHIEF ADVISORS

P. Sinclair, *Professor of Mathematics*, IGNOU, New Delhi

G.P. Dikshit, *Professor (Retd.)*, Lucknow University, Lucknow

### CHIEF COORDINATOR

Hukum Singh, *Professor and Head (Retd.)*, DESM, NCERT, New Delhi

### MEMBERS

Anjali Lal, *PGT*, DAV Public School, Sector-14, Gurgaon

A.K. Wazalwar, *Professor and Head*, DESM, NCERT

B.S. Upadhyaya, *Professor*, RIE, Mysore

Jayanti Datta, *PGT*, Salwan Public School, Gurgaon

Mahendra Shanker, *Lecturer (S.G.) (Retd.)*, NCERT

Manica Aggarwal, Green Park, New Delhi

N.D. Shukla, *Professor (Retd.)*, Lucknow University, Lucknow

Ram Avtar, *Professor (Retd.) & Consultant*, DESM, NCERT

Rama Balaji, *TGT*, K.V., MEG & Centre, St. John's Road, Bangalore

S. Jagdeeshan, *Teacher and Member*, Governing Council, Centre for Learning, Bangalore

S.K.S. Gautam, *Professor (Retd.)*, DESM, NCERT

Vandita Kalra, *Lecturer*, Sarvodaya Kanya Vidyalaya, Vikaspuri District Centre, Delhi

V.A. Sujatha, *TGT*, Kendriya Vidyalaya No. 1, Vasco, Goa

V. Madhavi, *TGT*, Sanskriti School, Chankyapuri, New Delhi

### MEMBER-COORDINATOR

R.P. Maurya, *Professor*, DESM, NCERT, New Delhi

## Acknowledgements

The Council gratefully acknowledges the valuable contributions of the following participants of the Textbook Review Workshop:

Mala Mani, *TGT*, Amity International School, Sector-44, Noida; Meera Mahadevan, *TGT*, Atomic Energy Central School, No. 4, Anushakti Nagar, Mumbai; Rashmi Rana, *TGT*, D.A.V. Public School, Pushpanjali Enclave, Pitampura, Delhi; Mohammad Qasim, *TGT*, Anglo Arabic Senior Secondary School, Ajmeri Gate, Delhi; S.C. Rauto, *TGT*, Central School for Tibetans, Happy Valley, Mussoorie; Rakesh Kaushik, *TGT*, Sainik School, Kunjpura, Karnal; Ashok Kumar Gupta, *TGT*, Jawahar Navodaya Vidyalaya, Dudhnoi, Distt. Goalpara; Sankar Misra, *TGT*, Demonstration Multipurpose School, RIE, Bhubaneswar; Uaday Singh, *Lecturer*, Department of Mathematics, B.H.U., Varanasi; B.R. Handa, *Emeritus Professor*, IIT, New Delhi; Monika Singh, *Lecturer*, Sri Ram College (University of Delhi), Lajpat Nagar, New Delhi; G. Sri Hari Babu, *TGT*, Jawahar Navodaya Vidyalaya, Sirpur, Kagaz Nagar, Adilabad; Ajay Kumar Singh, *TGT*, Ramjas Sr. Secondary School No. 3, Chandni Chowk, Delhi; Mukesh Kumar Agrawal, *TGT*, S.S.A.P.G.B.S.S. School, Sector-V, Dr Ambedkar Nagar, New Delhi.

Special thanks are due to Professor Hukum Singh, *Head (Retd.)*, DESM, NCERT for his support during the development of this book.

The Council acknowledges the efforts of Deepak Kapoor, *Incharge*, Computer Station; Purnendu Kumar Barik, *Copy Editor*; Naresh Kumar and Nargis Islam, *D.T.P. Operators*; Yogita Sharma, *Proof Reader*.

The Contribution of APC-Office, administration of DESM, Publication Department and Secretariat of NCERT is also duly acknowledged.

## Contents

<i>Foreword</i>	<i>iii</i>
<i>Preface</i>	<i>v</i>
<b>1. Real Numbers</b>	<b>1</b>
1.1 Introduction	1
1.2 Euclid's Division Lemma	2
1.3 The Fundamental Theorem of Arithmetic	7
1.4 Revisiting Irrational Numbers	11
1.5 Revisiting Rational Numbers and Their Decimal Expansions	15
1.6 Summary	18
<b>2. Polynomials</b>	<b>20</b>
2.1 Introduction	20
2.2 Geometrical Meaning of the Zeroes of a Polynomial	21
2.3 Relationship between Zeroes and Coefficients of a Polynomial	28
2.4 Division Algorithm for Polynomials	33
2.5 Summary	37
<b>3. Pair of Linear Equations in Two Variables</b>	<b>38</b>
3.1 Introduction	38
3.2 Pair of Linear Equations in Two Variables	39
3.3 Graphical Method of Solution of a Pair of Linear Equations	44
3.4 Algebraic Methods of Solving a Pair of Linear Equations	50
3.4.1 Substitution Method	50
3.4.2 Elimination Method	54
3.4.3 Cross-Multiplication Method	57
3.5 Equations Reducible to a Pair of Linear Equations in Two Variables	63
3.6 Summary	69
<b>4. Quadratic Equations</b>	<b>70</b>
4.1 Introduction	70
4.2 Quadratic Equations	71

4.3	Solution of a Quadratic Equation by Factorisation	74
4.4	Solution of a Quadratic Equation by Completing the Square	76
4.5	Nature of Roots	88
4.6	Summary	91
<b>5.</b>	<b>Arithmetic Progressions</b>	<b>93</b>
5.1	Introduction	93
5.2	Arithmetic Progressions	95
5.3	$n$ th Term of an AP	100
5.4	Sum of First $n$ Terms of an AP	107
5.5	Summary	116
<b>6.</b>	<b>Triangles</b>	<b>117</b>
6.1	Introduction	117
6.2	Similar Figures	118
6.3	Similarity of Triangles	123
6.4	Criteria for Similarity of Triangles	129
6.5	Areas of Similar Triangles	141
6.6	Pythagoras Theorem	144
6.7	Summary	154
<b>7.</b>	<b>Coordinate Geometry</b>	<b>155</b>
7.1	Introduction	155
7.2	Distance Formula	156
7.3	Section Formula	162
7.4	Area of a Triangle	168
7.5	Summary	172
<b>8.</b>	<b>Introduction to Trigonometry</b>	<b>173</b>
8.1	Introduction	173
8.2	Trigonometric Ratios	174
8.3	Trigonometric Ratios of Some Specific Angles	181
8.4	Trigonometric Ratios of Complementary Angles	187
8.5	Trigonometric Identities	190
8.6	Summary	194

<b>9. Some Applications of Trigonometry</b>	<b>195</b>
9.1 Introduction	195
9.2 Heights and Distances	196
9.3 Summary	205
<b>10. Circles</b>	<b>206</b>
10.1 Introduction	206
10.2 Tangent to a Circle	207
10.3 Number of Tangents from a Point on a Circle	209
10.4 Summary	215
<b>11. Constructions</b>	<b>216</b>
11.1 Introduction	216
11.2 Division of a Line Segment	216
11.3 Construction of Tangents to a Circle	220
11.4 Summary	222
<b>12. Areas Related to Circles</b>	<b>223</b>
12.1 Introduction	223
12.2 Perimeter and Area of a Circle — A Review	224
12.3 Areas of Sector and Segment of a Circle	226
12.4 Areas of Combinations of Plane Figures	231
12.5 Summary	238
<b>13. Surface Areas and Volumes</b>	<b>239</b>
13.1 Introduction	239
13.2 Surface Area of a Combination of Solids	240
13.3 Volume of a Combination of Solids	245
13.4 Conversion of Solid from One Shape to Another	248
13.5 Frustum of a Cone	252
13.6 Summary	258
<b>14. Statistics</b>	<b>260</b>
14.1 Introduction	260
14.2 Mean of Grouped Data	260
14.3 Mode of Grouped Data	272

14.4 Median of Grouped Data	277
14.5 Graphical Representation of Cumulative Frequency Distribution	289
14.6 Summary	293
<b>15. Probability</b>	<b>295</b>
15.1 Introduction	295
15.2 Probability — A Theoretical Approach	296
15.3 Summary	312
<b>Appendix A1 : Proofs in Mathematics</b>	<b>313</b>
A1.1 Introduction	313
A1.2 Mathematical Statements Revisited	313
A1.3 Deductive Reasoning	316
A1.4 Conjectures, Theorems, Proofs and Mathematical Reasoning	318
A1.5 Negation of a Statement	323
A1.6 Converse of a Statement	326
A1.7 Proof by Contradiction	329
A1.8 Summary	333
<b>Appendix A2 : Mathematical Modelling</b>	<b>334</b>
A2.1 Introduction	334
A2.2 Stages in Mathematical Modelling	335
A2.3 Some Illustrations	339
A2.4 Why is Mathematical Modelling Important?	343
A2.5 Summary	344
<b>Answers/Hints</b>	<b>345</b>



1062CH01

# REAL NUMBERS

# 1

## 1.1 Introduction

In Class IX, you began your exploration of the world of real numbers and encountered irrational numbers. We continue our discussion on real numbers in this chapter. We begin with two very important properties of positive integers in Sections 1.2 and 1.3, namely the Euclid's division algorithm and the Fundamental Theorem of Arithmetic.

Euclid's division algorithm, as the name suggests, has to do with divisibility of integers. Stated simply, it says any positive integer  $a$  can be divided by another positive integer  $b$  in such a way that it leaves a remainder  $r$  that is smaller than  $b$ . Many of you probably recognise this as the usual long division process. Although this result is quite easy to state and understand, it has many applications related to the divisibility properties of integers. We touch upon a few of them, and use it mainly to compute the HCF of two positive integers.

The Fundamental Theorem of Arithmetic, on the other hand, has to do something with multiplication of positive integers. You already know that every composite number can be expressed as a product of primes in a unique way — this important fact is the Fundamental Theorem of Arithmetic. Again, while it is a result that is easy to state and understand, it has some very deep and significant applications in the field of mathematics. We use the Fundamental Theorem of Arithmetic for two main applications. First, we use it to prove the irrationality of many of the numbers you studied in Class IX, such as  $\sqrt{2}$ ,  $\sqrt{3}$  and  $\sqrt{5}$ . Second, we apply this theorem to explore when exactly the decimal expansion of a rational number, say  $\frac{p}{q}$  ( $q \neq 0$ ), is terminating and when it is non-terminating repeating. We do so by looking at the prime factorisation of the denominator  $q$  of  $\frac{p}{q}$ . You will see that the prime factorisation of  $q$  will completely reveal the nature of the decimal expansion of  $\frac{p}{q}$ .

So let us begin our exploration.

## 1.2 Euclid's Division Lemma

Consider the following folk puzzle\*.

*A trader was moving along a road selling eggs. An idler who didn't have much work to do, started to get the trader into a wordy duel. This grew into a fight, he pulled the basket with eggs and dashed it on the floor. The eggs broke. The trader requested the Panchayat to ask the idler to pay for the broken eggs. The Panchayat asked the trader how many eggs were broken. He gave the following response:*

*If counted in pairs, one will remain;*

*If counted in threes, two will remain;*

*If counted in fours, three will remain;*

*If counted in fives, four will remain;*

*If counted in sixes, five will remain;*

*If counted in sevens, nothing will remain;*

*My basket cannot accomodate more than 150 eggs.*

So, how many eggs were there? Let us try and solve the puzzle. Let the number of eggs be  $a$ . Then working backwards, we see that  $a$  is less than or equal to 150:

If counted in sevens, nothing will remain, which translates to  $a = 7p + 0$ , for some natural number  $p$ . If counted in sixes,  $a = 6q + 5$ , for some natural number  $q$ .

If counted in fives, four will remain. It translates to  $a = 5w + 4$ , for some natural number  $w$ .

If counted in fours, three will remain. It translates to  $a = 4s + 3$ , for some natural number  $s$ .

If counted in threes, two will remain. It translates to  $a = 3t + 2$ , for some natural number  $t$ .

If counted in pairs, one will remain. It translates to  $a = 2u + 1$ , for some natural number  $u$ .

That is, in each case, we have  $a$  and a positive integer  $b$  (in our example,  $b$  takes values 7, 6, 5, 4, 3 and 2, respectively) which divides  $a$  and leaves a remainder  $r$  (in our case,  $r$  is 0, 5, 4, 3, 2 and 1, respectively), that is smaller than  $b$ . The

---

\* This is modified form of a puzzle given in 'Numeracy Counts!' by A. Rampal, and others.

moment we write down such equations we are using Euclid's division lemma, which is given in Theorem 1.1.

Getting back to our puzzle, do you have any idea how you will solve it? Yes! You must look for the multiples of 7 which satisfy all the conditions. By trial and error (using the concept of LCM), you will find he had 119 eggs.

In order to get a feel for what Euclid's division lemma is, consider the following pairs of integers:

$$17, 6; \quad 5, 12; \quad 20, 4$$

Like we did in the example, we can write the following relations for each such pair:

$$17 = 6 \times 2 + 5 \text{ (6 goes into 17 twice and leaves a remainder 5)}$$

$$5 = 12 \times 0 + 5 \text{ (This relation holds since 12 is larger than 5)}$$

$$20 = 4 \times 5 + 0 \text{ (Here 4 goes into 20 five-times and leaves no remainder)}$$

That is, for each pair of positive integers  $a$  and  $b$ , we have found whole numbers  $q$  and  $r$ , satisfying the relation:

$$a = bq + r, \quad 0 \leq r < b$$

**Note** that  $q$  or  $r$  can also be zero.

Why don't you now try finding integers  $q$  and  $r$  for the following pairs of positive integers  $a$  and  $b$ ?

(i) 10, 3;

(ii) 4, 19;

(iii) 81, 3

Did you notice that  $q$  and  $r$  are unique? These are the only integers satisfying the conditions  $a = bq + r$ , where  $0 \leq r < b$ . You may have also realised that this is nothing but a restatement of the long division process you have been doing all these years, and that the integers  $q$  and  $r$  are called the *quotient* and *remainder*, respectively.

A formal statement of this result is as follows :

**Theorem 1.1 (Euclid's Division Lemma) :** *Given positive integers  $a$  and  $b$ , there exist unique integers  $q$  and  $r$  satisfying  $a = bq + r$ ,  $0 \leq r < b$ .*

This result was perhaps known for a long time, but was first recorded in Book VII of Euclid's Elements. Euclid's division algorithm is based on this lemma.

An **algorithm** is a series of well defined steps which gives a procedure for solving a type of problem.

The word *algorithm* comes from the name of the 9th century Persian mathematician al-Khwarizmi. In fact, even the word ‘algebra’ is derived from a book, he wrote, called *Hisab al-jabr w’al-muqabala*.

A **lemma** is a proven statement used for proving another statement.



**Muhammad ibn Musa al-Khwarizmi**  
(C.E. 780 – 850)

Euclid’s division algorithm is a technique to compute the Highest Common Factor (HCF) of two given positive integers. Recall that the HCF of two positive integers  $a$  and  $b$  is the largest positive integer  $d$  that divides both  $a$  and  $b$ .

Let us see how the algorithm works, through an example first. Suppose we need to find the HCF of the integers 455 and 42. We start with the larger integer, that is, 455. Then we use Euclid’s lemma to get

$$455 = 42 \times 10 + 35$$

Now consider the divisor 42 and the remainder 35, and apply the division lemma to get

$$42 = 35 \times 1 + 7$$

Now consider the divisor 35 and the remainder 7, and apply the division lemma to get

$$35 = 7 \times 5 + 0$$

Notice that the remainder has become zero, and we cannot proceed any further. **We claim** that the HCF of 455 and 42 is the divisor at this stage, i.e., 7. You can easily verify this by listing all the factors of 455 and 42. Why does this method work? It works because of the following result.

So, let us state **Euclid’s division algorithm** clearly.

*To obtain the HCF of two positive integers, say  $c$  and  $d$ , with  $c > d$ , follow the steps below:*

- Step 1 :** Apply Euclid’s division lemma, to  $c$  and  $d$ . So, we find whole numbers,  $q$  and  $r$  such that  $c = dq + r$ ,  $0 \leq r < d$ .
- Step 2 :** If  $r = 0$ ,  $d$  is the HCF of  $c$  and  $d$ . If  $r \neq 0$ , apply the division lemma to  $d$  and  $r$ .
- Step 3 :** Continue the process till the remainder is zero. The divisor at this stage will be the required HCF.

This algorithm works because  $\text{HCF}(c, d) = \text{HCF}(d, r)$  where the symbol  $\text{HCF}(c, d)$  denotes the HCF of  $c$  and  $d$ , etc.

**Example 1 :** Use Euclid's algorithm to find the HCF of 4052 and 12576.

**Solution :**

**Step 1 :** Since  $12576 > 4052$ , we apply the division lemma to 12576 and 4052, to get

$$12576 = 4052 \times 3 + 420$$

**Step 2 :** Since the remainder  $420 \neq 0$ , we apply the division lemma to 4052 and 420, to get

$$4052 = 420 \times 9 + 272$$

**Step 3 :** We consider the new divisor 420 and the new remainder 272, and apply the division lemma to get

$$420 = 272 \times 1 + 148$$

We consider the new divisor 272 and the new remainder 148, and apply the division lemma to get

$$272 = 148 \times 1 + 124$$

We consider the new divisor 148 and the new remainder 124, and apply the division lemma to get

$$148 = 124 \times 1 + 24$$

We consider the new divisor 124 and the new remainder 24, and apply the division lemma to get

$$124 = 24 \times 5 + 4$$

We consider the new divisor 24 and the new remainder 4, and apply the division lemma to get

$$24 = 4 \times 6 + 0$$

The remainder has now become zero, so our procedure stops. Since the divisor at this stage is 4, the HCF of 12576 and 4052 is 4.

Notice that  $4 = \text{HCF}(24, 4) = \text{HCF}(124, 24) = \text{HCF}(148, 124) = \text{HCF}(272, 148) = \text{HCF}(420, 272) = \text{HCF}(4052, 420) = \text{HCF}(12576, 4052)$ .

Euclid's division algorithm is not only useful for calculating the HCF of very large numbers, but also because it is one of the earliest examples of an algorithm that a computer had been programmed to carry out.

**Remarks :**

1. Euclid's division lemma and algorithm are so closely interlinked that people often call former as the division algorithm also.
2. Although Euclid's Division Algorithm is stated for only positive integers, it can be extended for all integers except zero, i.e.,  $b \neq 0$ . However, we shall not discuss this aspect here.

Euclid's division lemma/algorithm has several applications related to finding properties of numbers. We give some examples of these applications below:

**Example 2 :** Show that every positive even integer is of the form  $2q$ , and that every positive odd integer is of the form  $2q + 1$ , where  $q$  is some integer.

**Solution :** Let  $a$  be any positive integer and  $b = 2$ . Then, by Euclid's algorithm,  $a = 2q + r$ , for some integer  $q \geq 0$ , and  $r = 0$  or  $r = 1$ , because  $0 \leq r < 2$ . So,  $a = 2q$  or  $2q + 1$ .

If  $a$  is of the form  $2q$ , then  $a$  is an even integer. Also, a positive integer can be either even or odd. Therefore, any positive odd integer is of the form  $2q + 1$ .

**Example 3 :** Show that any positive odd integer is of the form  $4q + 1$  or  $4q + 3$ , where  $q$  is some integer.

**Solution :** Let us start with taking  $a$ , where  $a$  is a positive odd integer. We apply the division algorithm with  $a$  and  $b = 4$ .

Since  $0 \leq r < 4$ , the possible remainders are 0, 1, 2 and 3.

That is,  $a$  can be  $4q$ , or  $4q + 1$ , or  $4q + 2$ , or  $4q + 3$ , where  $q$  is the quotient. However, since  $a$  is odd,  $a$  cannot be  $4q$  or  $4q + 2$  (since they are both divisible by 2). Therefore, any odd integer is of the form  $4q + 1$  or  $4q + 3$ .

**Example 4 :** A sweetseller has 420 *kaju barfis* and 130 *badam barfis*. She wants to stack them in such a way that each stack has the same number, and they take up the least area of the tray. What is the number of that can be placed in each stack for this purpose?

**Solution :** This can be done by trial and error. But to do it systematically, we find HCF (420, 130). Then this number will give the maximum number of *barfis* in each stack and the number of stacks will then be the least. The area of the tray that is used up will be the least.

Now, let us use Euclid's algorithm to find their HCF. We have :

$$420 = 130 \times 3 + 30$$

$$130 = 30 \times 4 + 10$$

$$30 = 10 \times 3 + 0$$

So, the HCF of 420 and 130 is 10.

Therefore, the sweetseller can make stacks of 10 for both kinds of *barfi*.

### EXERCISE 1.1

- Use Euclid's division algorithm to find the HCF of :
  - 135 and 225
  - 196 and 38220
  - 867 and 255
- Show that any positive odd integer is of the form  $6q + 1$ , or  $6q + 3$ , or  $6q + 5$ , where  $q$  is some integer.
- An army contingent of 616 members is to march behind an army band of 32 members in a parade. The two groups are to march in the same number of columns. What is the maximum number of columns in which they can march?
- Use Euclid's division lemma to show that the square of any positive integer is either of the form  $3m$  or  $3m + 1$  for some integer  $m$ .  
 [Hint : Let  $x$  be any positive integer then it is of the form  $3q$ ,  $3q + 1$  or  $3q + 2$ . Now square each of these and show that they can be rewritten in the form  $3m$  or  $3m + 1$ .]
- Use Euclid's division lemma to show that the cube of any positive integer is of the form  $9m$ ,  $9m + 1$  or  $9m + 8$ .

### 1.3 The Fundamental Theorem of Arithmetic

In your earlier classes, you have seen that any natural number can be written as a product of its prime factors. For instance,  $2 = 2$ ,  $4 = 2 \times 2$ ,  $253 = 11 \times 23$ , and so on. Now, let us try and look at natural numbers from the other direction. That is, can any natural number be obtained by multiplying prime numbers? Let us see.

Take any collection of prime numbers, say 2, 3, 7, 11 and 23. If we multiply some or all of these numbers, allowing them to repeat as many times as we wish, we can produce a large collection of positive integers (In fact, infinitely many). Let us list a few :

$$7 \times 11 \times 23 = 1771$$

$$3 \times 7 \times 11 \times 23 = 5313$$

$$2 \times 3 \times 7 \times 11 \times 23 = 10626$$

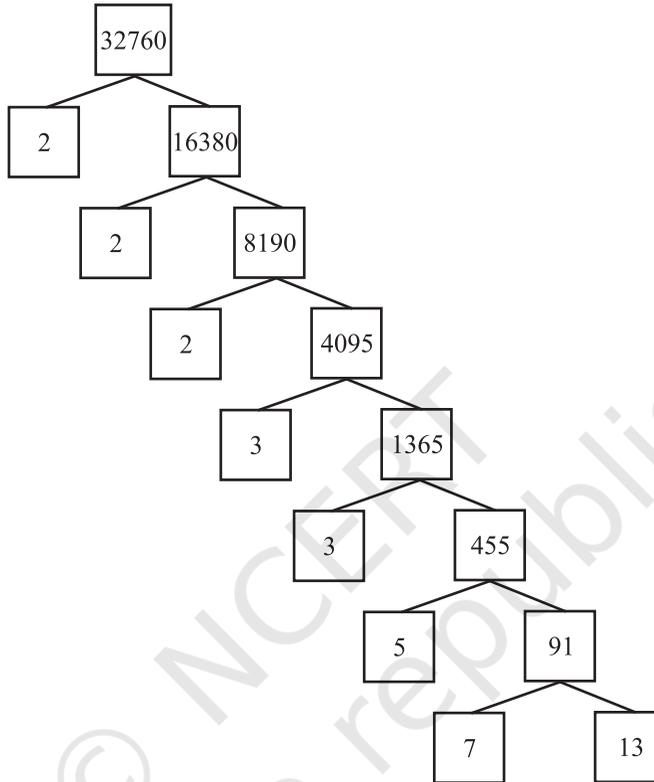
$$2^3 \times 3 \times 7^3 = 8232$$

$$2^2 \times 3 \times 7 \times 11 \times 23 = 21252$$

and so on.

Now, let us suppose your collection of primes includes all the possible primes. What is your guess about the size of this collection? Does it contain only a finite number of integers, or infinitely many? Infact, there are infinitely many primes. So, if we combine all these primes in all possible ways, we will get an infinite collection of numbers, all the primes and all possible products of primes. The question is – can we produce all the composite numbers this way? What do you think? Do you think that there may be a composite number which is not the product of powers of primes? Before we answer this, let us factorise positive integers, that is, do the opposite of what we have done so far.

We are going to use the factor tree with which you are all familiar. Let us take some large number, say, 32760, and factorise it as shown :



So we have factorised 32760 as  $2 \times 2 \times 2 \times 3 \times 3 \times 5 \times 7 \times 13$  as a product of primes, i.e.,  $32760 = 2^3 \times 3^2 \times 5 \times 7 \times 13$  as a product of powers of primes. Let us try another number, say, 123456789. This can be written as  $3^2 \times 3803 \times 3607$ . Of course, you have to check that 3803 and 3607 are primes! (Try it out for several other natural numbers yourself.) This leads us to a conjecture that every composite number can be written as the product of powers of primes. In fact, this statement is true, and is called the **Fundamental Theorem of Arithmetic** because of its basic crucial importance to the study of integers. Let us now formally state this theorem.

**Theorem 1.2 (Fundamental Theorem of Arithmetic) :** *Every composite number can be expressed (factorised) as a product of primes, and this factorisation is unique, apart from the order in which the prime factors occur.*

An equivalent version of Theorem 1.2 was probably first recorded as Proposition 14 of Book IX in Euclid's Elements, before it came to be known as the Fundamental Theorem of Arithmetic. However, the first correct proof was given by Carl Friedrich Gauss in his *Disquisitiones Arithmeticae*.

Carl Friedrich Gauss is often referred to as the 'Prince of Mathematicians' and is considered one of the three greatest mathematicians of all time, along with Archimedes and Newton. He has made fundamental contributions to both mathematics and science.



**Carl Friedrich Gauss**  
(1777 – 1855)

The Fundamental Theorem of Arithmetic says that every composite number can be factorised as a product of primes. Actually it says more. It says that given any composite number it can be factorised as a product of prime numbers in a '**unique**' way, except for the order in which the primes occur. That is, given any composite number there is one and only one way to write it as a product of primes, as long as we are not particular about the order in which the primes occur. So, for example, we regard  $2 \times 3 \times 5 \times 7$  as the same as  $3 \times 5 \times 7 \times 2$ , or any other possible order in which these primes are written. This fact is also stated in the following form:

*The prime factorisation of a natural number is unique, except for the order of its factors.*

In general, given a composite number  $x$ , we factorise it as  $x = p_1 p_2 \dots p_n$ , where  $p_1, p_2, \dots, p_n$  are primes and written in ascending order, i.e.,  $p_1 \leq p_2 \leq \dots \leq p_n$ . If we combine the same primes, we will get powers of primes. For example,

$$32760 = 2 \times 2 \times 2 \times 3 \times 3 \times 5 \times 7 \times 13 = 2^3 \times 3^2 \times 5 \times 7 \times 13$$

Once we have decided that the order will be ascending, then the way the number is factorised, is unique.

The Fundamental Theorem of Arithmetic has many applications, both within mathematics and in other fields. Let us look at some examples.

**Example 5 :** Consider the numbers  $4^n$ , where  $n$  is a natural number. Check whether there is any value of  $n$  for which  $4^n$  ends with the digit zero.

**Solution :** If the number  $4^n$ , for any  $n$ , were to end with the digit zero, then it would be divisible by 5. That is, the prime factorisation of  $4^n$  would contain the prime 5. This is

not possible because  $4^n = (2)^{2n}$ ; so the only prime in the factorisation of  $4^n$  is 2. So, the uniqueness of the Fundamental Theorem of Arithmetic guarantees that there are no other primes in the factorisation of  $4^n$ . So, there is no natural number  $n$  for which  $4^n$  ends with the digit zero.

You have already learnt how to find the HCF and LCM of two positive integers using the Fundamental Theorem of Arithmetic in earlier classes, without realising it! This method is also called the *prime factorisation method*. Let us recall this method through an example.

**Example 6 :** Find the LCM and HCF of 6 and 20 by the prime factorisation method.

**Solution :** We have :  $6 = 2^1 \times 3^1$  and  $20 = 2 \times 2 \times 5 = 2^2 \times 5^1$ .

You can find  $\text{HCF}(6, 20) = 2$  and  $\text{LCM}(6, 20) = 2 \times 2 \times 3 \times 5 = 60$ , as done in your earlier classes.

Note that  $\text{HCF}(6, 20) = 2^1 =$  **Product of the smallest power of each common prime factor in the numbers.**

$\text{LCM}(6, 20) = 2^2 \times 3^1 \times 5^1 =$  **Product of the greatest power of each prime factor, involved in the numbers.**

From the example above, you might have noticed that  $\text{HCF}(6, 20) \times \text{LCM}(6, 20) = 6 \times 20$ . In fact, we can verify that **for any two positive integers  $a$  and  $b$ ,  $\text{HCF}(a, b) \times \text{LCM}(a, b) = a \times b$** . We can use this result to find the LCM of two positive integers, if we have already found the HCF of the two positive integers.

**Example 7 :** Find the HCF of 96 and 404 by the prime factorisation method. Hence, find their LCM.

**Solution :** The prime factorisation of 96 and 404 gives :

$$96 = 2^5 \times 3, \quad 404 = 2^2 \times 101$$

Therefore, the HCF of these two integers is  $2^2 = 4$ .

Also,

$$\text{LCM}(96, 404) = \frac{96 \times 404}{\text{HCF}(96, 404)} = \frac{96 \times 404}{4} = 9696$$

**Example 8 :** Find the HCF and LCM of 6, 72 and 120, using the prime factorisation method.

**Solution :** We have :

$$6 = 2 \times 3, \quad 72 = 2^3 \times 3^2, \quad 120 = 2^3 \times 3 \times 5$$

Here,  $2^1$  and  $3^1$  are the smallest powers of the common factors 2 and 3, respectively.

So,  $\text{HCF}(6, 72, 120) = 2^1 \times 3^1 = 2 \times 3 = 6$

$2^3, 3^2$  and  $5^1$  are the greatest powers of the prime factors 2, 3 and 5 respectively involved in the three numbers.

So,  $\text{LCM}(6, 72, 120) = 2^3 \times 3^2 \times 5^1 = 360$

**Remark :** Notice,  $6 \times 72 \times 120 \neq \text{HCF}(6, 72, 120) \times \text{LCM}(6, 72, 120)$ . So, the product of three numbers is not equal to the product of their HCF and LCM.

### EXERCISE 1.2

- Express each number as a product of its prime factors:  
(i) 140                      (ii) 156                      (iii) 3825                      (iv) 5005                      (v) 7429
- Find the LCM and HCF of the following pairs of integers and verify that  $\text{LCM} \times \text{HCF} =$  product of the two numbers.  
(i) 26 and 91                      (ii) 510 and 92                      (iii) 336 and 54
- Find the LCM and HCF of the following integers by applying the prime factorisation method.  
(i) 12, 15 and 21                      (ii) 17, 23 and 29                      (iii) 8, 9 and 25
- Given that  $\text{HCF}(306, 657) = 9$ , find  $\text{LCM}(306, 657)$ .
- Check whether  $6^n$  can end with the digit 0 for any natural number  $n$ .
- Explain why  $7 \times 11 \times 13 + 13$  and  $7 \times 6 \times 5 \times 4 \times 3 \times 2 \times 1 + 5$  are composite numbers.
- There is a circular path around a sports field. Sonia takes 18 minutes to drive one round of the field, while Ravi takes 12 minutes for the same. Suppose they both start at the same point and at the same time, and go in the same direction. After how many minutes will they meet again at the starting point?

### 1.4 Revisiting Irrational Numbers

In Class IX, you were introduced to irrational numbers and many of their properties. You studied about their existence and how the rationals and the irrationals together made up the real numbers. You even studied how to locate irrationals on the number line. However, we did not prove that they were irrationals. In this section, we will prove that  $\sqrt{2}$ ,  $\sqrt{3}$ ,  $\sqrt{5}$  and, in general,  $\sqrt{p}$  is irrational, where  $p$  is a prime. One of the theorems, we use in our proof, is the Fundamental Theorem of Arithmetic.

Recall, a number 's' is called *irrational* if it cannot be written in the form  $\frac{p}{q}$ , where  $p$  and  $q$  are integers and  $q \neq 0$ . Some examples of irrational numbers, with

which you are already familiar, are :

$$\sqrt{2}, \sqrt{3}, \sqrt{15}, \pi, -\frac{\sqrt{2}}{\sqrt{3}}, 0.10110111011110\dots, \text{etc.}$$

Before we prove that  $\sqrt{2}$  is irrational, we need the following theorem, whose proof is based on the Fundamental Theorem of Arithmetic.

**Theorem 1.3 :** *Let  $p$  be a prime number. If  $p$  divides  $a^2$ , then  $p$  divides  $a$ , where  $a$  is a positive integer.*

**\*Proof :** Let the prime factorisation of  $a$  be as follows :

$$a = p_1 p_2 \dots p_n, \text{ where } p_1, p_2, \dots, p_n \text{ are primes, not necessarily distinct.}$$

$$\text{Therefore, } a^2 = (p_1 p_2 \dots p_n)(p_1 p_2 \dots p_n) = p_1^2 p_2^2 \dots p_n^2.$$

Now, we are given that  $p$  divides  $a^2$ . Therefore, from the Fundamental Theorem of Arithmetic, it follows that  $p$  is one of the prime factors of  $a^2$ . However, using the uniqueness part of the Fundamental Theorem of Arithmetic, we realise that the only prime factors of  $a^2$  are  $p_1, p_2, \dots, p_n$ . So  $p$  is one of  $p_1, p_2, \dots, p_n$ .

Now, since  $a = p_1 p_2 \dots p_n$ ,  $p$  divides  $a$ .

We are now ready to give a proof that  $\sqrt{2}$  is irrational.

The proof is based on a technique called ‘proof by contradiction’. (This technique is discussed in some detail in Appendix 1).

**Theorem 1.4 :**  *$\sqrt{2}$  is irrational.*

**Proof :** Let us assume, to the contrary, that  $\sqrt{2}$  is rational.

So, we can find integers  $r$  and  $s$  ( $\neq 0$ ) such that  $\sqrt{2} = \frac{r}{s}$ .

Suppose  $r$  and  $s$  have a common factor other than 1. Then, we divide by the common

factor to get  $\sqrt{2} = \frac{a}{b}$ , where  $a$  and  $b$  are coprime.

$$\text{So, } b\sqrt{2} = a.$$

Squaring on both sides and rearranging, we get  $2b^2 = a^2$ . Therefore, 2 divides  $a^2$ .

Now, by Theorem 1.3, it follows that 2 divides  $a$ .

So, we can write  $a = 2c$  for some integer  $c$ .

---

\* Not from the examination point of view.

Substituting for  $a$ , we get  $2b^2 = 4c^2$ , that is,  $b^2 = 2c^2$ .

This means that 2 divides  $b^2$ , and so 2 divides  $b$  (again using Theorem 1.3 with  $p = 2$ ).

Therefore,  $a$  and  $b$  have at least 2 as a common factor.

But this contradicts the fact that  $a$  and  $b$  have no common factors other than 1.

This contradiction has arisen because of our incorrect assumption that  $\sqrt{2}$  is rational.

So, we conclude that  $\sqrt{2}$  is irrational.

**Example 9 :** Prove that  $\sqrt{3}$  is irrational.

**Solution :** Let us assume, to the contrary, that  $\sqrt{3}$  is rational.

That is, we can find integers  $a$  and  $b$  ( $\neq 0$ ) such that  $\sqrt{3} = \frac{a}{b}$ .

Suppose  $a$  and  $b$  have a common factor other than 1, then we can divide by the common factor, and assume that  $a$  and  $b$  are coprime.

So,  $b\sqrt{3} = a$ .

Squaring on both sides, and rearranging, we get  $3b^2 = a^2$ .

Therefore,  $a^2$  is divisible by 3, and by Theorem 1.3, it follows that  $a$  is also divisible by 3.

So, we can write  $a = 3c$  for some integer  $c$ .

Substituting for  $a$ , we get  $3b^2 = 9c^2$ , that is,  $b^2 = 3c^2$ .

This means that  $b^2$  is divisible by 3, and so  $b$  is also divisible by 3 (using Theorem 1.3 with  $p = 3$ ).

Therefore,  $a$  and  $b$  have at least 3 as a common factor.

But this contradicts the fact that  $a$  and  $b$  are coprime.

This contradiction has arisen because of our incorrect assumption that  $\sqrt{3}$  is rational.

So, we conclude that  $\sqrt{3}$  is irrational.

In Class IX, we mentioned that :

- the sum or difference of a rational and an irrational number is irrational and
- the product and quotient of a non-zero rational and irrational number is irrational.

We prove some particular cases here.

**Example 10 :** Show that  $5 - \sqrt{3}$  is irrational.

**Solution :** Let us assume, to the contrary, that  $5 - \sqrt{3}$  is rational.

That is, we can find coprime  $a$  and  $b$  ( $b \neq 0$ ) such that  $5 - \sqrt{3} = \frac{a}{b}$ .

Therefore,  $5 - \frac{a}{b} = \sqrt{3}$ .

Rearranging this equation, we get  $\sqrt{3} = 5 - \frac{a}{b} = \frac{5b - a}{b}$ .

Since  $a$  and  $b$  are integers, we get  $5 - \frac{a}{b}$  is rational, and so  $\sqrt{3}$  is rational.

But this contradicts the fact that  $\sqrt{3}$  is irrational.

This contradiction has arisen because of our incorrect assumption that  $5 - \sqrt{3}$  is rational.

So, we conclude that  $5 - \sqrt{3}$  is irrational.

**Example 11 :** Show that  $3\sqrt{2}$  is irrational.

**Solution :** Let us assume, to the contrary, that  $3\sqrt{2}$  is rational.

That is, we can find coprime  $a$  and  $b$  ( $b \neq 0$ ) such that  $3\sqrt{2} = \frac{a}{b}$ .

Rearranging, we get  $\sqrt{2} = \frac{a}{3b}$ .

Since  $3$ ,  $a$  and  $b$  are integers,  $\frac{a}{3b}$  is rational, and so  $\sqrt{2}$  is rational.

But this contradicts the fact that  $\sqrt{2}$  is irrational.

So, we conclude that  $3\sqrt{2}$  is irrational.

### EXERCISE 1.3

1. Prove that  $\sqrt{5}$  is irrational.
2. Prove that  $3 + 2\sqrt{5}$  is irrational.
3. Prove that the following are irrationals :

(i)  $\frac{1}{\sqrt{2}}$

(ii)  $7\sqrt{5}$

(iii)  $6 + \sqrt{2}$

## 1.5 Revisiting Rational Numbers and Their Decimal Expansions

In Class IX, you studied that rational numbers have either a terminating decimal expansion or a non-terminating repeating decimal expansion. In this section, we are going to consider a rational number, say  $\frac{p}{q}$  ( $q \neq 0$ ), and explore exactly when the decimal expansion of  $\frac{p}{q}$  is terminating and when it is non-terminating repeating (or recurring). We do so by considering several examples.

Let us consider the following rational numbers :

$$(i) 0.375 \quad (ii) 0.104 \quad (iii) 0.0875 \quad (iv) 23.3408.$$

$$\begin{aligned} \text{Now} \quad (i) \quad 0.375 &= \frac{375}{1000} = \frac{375}{10^3} & (ii) \quad 0.104 &= \frac{104}{1000} = \frac{104}{10^3} \\ (iii) \quad 0.0875 &= \frac{875}{10000} = \frac{875}{10^4} & (iv) \quad 23.3408 &= \frac{233408}{10000} = \frac{233408}{10^4} \end{aligned}$$

As one would expect, they can all be expressed as rational numbers whose denominators are powers of 10. Let us try and cancel the common factors between the numerator and denominator and see what we get :

$$\begin{aligned} (i) \quad 0.375 &= \frac{375}{10^3} = \frac{3 \times 5^3}{2^3 \times 5^3} = \frac{3}{2^3} & (ii) \quad 0.104 &= \frac{104}{10^3} = \frac{13 \times 2^3}{2^3 \times 5^3} = \frac{13}{5^3} \\ (iii) \quad 0.0875 &= \frac{875}{10^4} = \frac{7}{2^4 \times 5} & (iv) \quad 23.3408 &= \frac{233408}{10^4} = \frac{2^2 \times 7 \times 521}{5^4} \end{aligned}$$

Do you see any pattern? It appears that, we have converted a real number whose decimal expansion terminates into a rational number of the form  $\frac{p}{q}$ , where  $p$  and  $q$  are coprime, and the prime factorisation of the denominator (that is,  $q$ ) has only powers of 2, or powers of 5, or both. We should expect the denominator to look like this, since powers of 10 can only have powers of 2 and 5 as factors.

Even though, we have worked only with a few examples, you can see that any real number which has a decimal expansion that terminates can be expressed as a rational number whose denominator is a power of 10. Also the only prime factors of 10 are 2 and 5. So, cancelling out the common factors between the numerator and the denominator, we find that this real number is a rational number of the form  $\frac{p}{q}$ , where the prime factorisation of  $q$  is of the form  $2^n 5^m$ , and  $n, m$  are some non-negative integers.

Let us write our result formally:

**Theorem 1.5 :** Let  $x$  be a rational number whose decimal expansion terminates. Then  $x$  can be expressed in the form  $\frac{p}{q}$ , where  $p$  and  $q$  are coprime, and the prime factorisation of  $q$  is of the form  $2^n 5^m$ , where  $n, m$  are non-negative integers.

You are probably wondering what happens the other way round in Theorem 1.5. That is, if we have a rational number of the form  $\frac{p}{q}$ , and the prime factorisation of  $q$  is of the form  $2^n 5^m$ , where  $n, m$  are non negative integers, then does  $\frac{p}{q}$  have a terminating decimal expansion?

Let us see if there is some obvious reason why this is true. You will surely agree that any rational number of the form  $\frac{a}{b}$ , where  $b$  is a power of 10, will have a terminating decimal expansion. So it seems to make sense to convert a rational number of the form  $\frac{p}{q}$ , where  $q$  is of the form  $2^n 5^m$ , to an equivalent rational number of the form  $\frac{a}{b}$ , where  $b$  is a power of 10. Let us go back to our examples above and work backwards.

$$(i) \quad \frac{3}{8} = \frac{3}{2^3} = \frac{3 \times 5^3}{2^3 \times 5^3} = \frac{375}{10^3} = 0.375$$

$$(ii) \quad \frac{13}{125} = \frac{13}{5^3} = \frac{13 \times 2^3}{2^3 \times 5^3} = \frac{104}{10^3} = 0.104$$

$$(iii) \quad \frac{7}{80} = \frac{7}{2^4 \times 5} = \frac{7 \times 5^3}{2^4 \times 5^4} = \frac{875}{10^4} = 0.0875$$

$$(iv) \quad \frac{14588}{625} = \frac{2^2 \times 7 \times 521}{5^4} = \frac{2^6 \times 7 \times 521}{2^4 \times 5^4} = \frac{233408}{10^4} = 23.3408$$

So, these examples show us how we can convert a rational number of the form  $\frac{p}{q}$ , where  $q$  is of the form  $2^n 5^m$ , to an equivalent rational number of the form  $\frac{a}{b}$ , where  $b$  is a power of 10. Therefore, the decimal expansion of such a rational number terminates. Let us write down our result formally.

**Theorem 1.6 :** Let  $x = \frac{p}{q}$  be a rational number, such that the prime factorisation of  $q$  is of the form  $2^n 5^m$ , where  $n, m$  are non-negative integers. Then  $x$  has a decimal expansion which terminates.

We are now ready to move on to the rational numbers whose decimal expansions are non-terminating and recurring. Once again, let us look at an example to see what is going on. We refer to Example 5, Chapter 1, from your Class IX textbook, namely,  $\frac{1}{7}$ . Here, remainders are 3, 2, 6, 4, 5, 1, 3, 2, 6, 4, 5, 1, ... and divisor is 7.

Notice that the denominator here, i.e., 7 is clearly not of the form  $2^n5^m$ . Therefore, from Theorems 1.5 and 1.6, we know that  $\frac{1}{7}$  will not have a terminating decimal expansion. Hence, 0 will not show up as a remainder (Why?), and the remainders will start repeating after a certain stage. So, we will have a block of digits, namely, 142857, repeating in the quotient of  $\frac{1}{7}$ .

What we have seen, in the case of  $\frac{1}{7}$ , is true for any rational number not covered by Theorems 1.5 and 1.6. For such numbers we have :

**Theorem 1.7 :** Let  $x = \frac{p}{q}$ , where  $p$  and  $q$  are coprimes, be a rational number, such that the prime factorisation of  $q$  is not of the form  $2^n5^m$ , where  $n, m$  are non-negative integers. Then,  $x$  has a decimal expansion which is non-terminating repeating (recurring).

From the discussion above, we can conclude that *the decimal expansion of every rational number is either terminating or non-terminating repeating.*

$$\begin{array}{r}
 0.1428571 \\
 7 \overline{)10} \\
 \underline{7} \\
 \textcircled{3}0 \\
 \underline{28} \\
 \textcircled{2}0 \\
 \underline{14} \\
 \textcircled{6}0 \\
 \underline{56} \\
 \textcircled{4}0 \\
 \underline{35} \\
 \textcircled{5}0 \\
 \underline{49} \\
 \textcircled{1}0 \\
 \underline{7} \\
 \textcircled{3}0
 \end{array}$$

**EXERCISE 1.4**

1. Without actually performing the long division, state whether the following rational numbers will have a terminating decimal expansion or a non-terminating repeating decimal expansion:

(i)  $\frac{13}{3125}$

(ii)  $\frac{17}{8}$

(iii)  $\frac{64}{455}$

(iv)  $\frac{15}{1600}$

(v)  $\frac{29}{343}$

(vi)  $\frac{23}{2^35^2}$

(vii)  $\frac{129}{2^25^77^5}$

(viii)  $\frac{6}{15}$

(ix)  $\frac{35}{50}$

(x)  $\frac{77}{210}$

2. Write down the decimal expansions of those rational numbers in Question 1 above which have terminating decimal expansions.
3. The following real numbers have decimal expansions as given below. In each case, decide whether they are rational or not. If they are rational, and of the form  $\frac{p}{q}$ , what can you say about the prime factors of  $q$ ?
  - (i) 43.123456789
  - (ii) 0.120120012000120000...
  - (iii)  $43.\overline{123456789}$

## 1.6 Summary

In this chapter, you have studied the following points:

1. Euclid's division lemma :

Given positive integers  $a$  and  $b$ , there exist whole numbers  $q$  and  $r$  satisfying  $a = bq + r$ ,  $0 \leq r < b$ .

2. Euclid's division algorithm : This is based on Euclid's division lemma. According to this, the HCF of any two positive integers  $a$  and  $b$ , with  $a > b$ , is obtained as follows:

**Step 1 :** Apply the division lemma to find  $q$  and  $r$  where  $a = bq + r$ ,  $0 \leq r < b$ .

**Step 2 :** If  $r = 0$ , the HCF is  $b$ . If  $r \neq 0$ , apply Euclid's lemma to  $b$  and  $r$ .

**Step 3 :** Continue the process till the remainder is zero. The divisor at this stage will be HCF( $a, b$ ). Also, HCF( $a, b$ ) = HCF( $b, r$ ).

3. The Fundamental Theorem of Arithmetic :

Every composite number can be expressed (factorised) as a product of primes, and this factorisation is unique, apart from the order in which the prime factors occur.

4. If  $p$  is a prime and  $p$  divides  $a^2$ , then  $p$  divides  $a$ , where  $a$  is a positive integer.
5. To prove that  $\sqrt{2}$ ,  $\sqrt{3}$  are irrationals.
6. Let  $x$  be a rational number whose decimal expansion terminates. Then we can express  $x$  in the form  $\frac{p}{q}$ , where  $p$  and  $q$  are coprime, and the prime factorisation of  $q$  is of the form  $2^n 5^m$ , where  $n, m$  are non-negative integers.
7. Let  $x = \frac{p}{q}$  be a rational number, such that the prime factorisation of  $q$  is of the form  $2^n 5^m$ , where  $n, m$  are non-negative integers. Then  $x$  has a decimal expansion which terminates.
8. Let  $x = \frac{p}{q}$  be a rational number, such that the prime factorisation of  $q$  is not of the form  $2^n 5^m$ , where  $n, m$  are non-negative integers. Then  $x$  has a decimal expansion which is non-terminating repeating (recurring).

**A NOTE TO THE READER**

You have seen that :

$\text{HCF}(p, q, r) \times \text{LCM}(p, q, r) \neq p \times q \times r$ , where  $p, q, r$  are positive integers (see Example 8). However, the following results hold good for three numbers  $p, q$  and  $r$  :

$$\text{LCM}(p, q, r) = \frac{p \cdot q \cdot r \cdot \text{HCF}(p, q, r)}{\text{HCF}(p, q) \cdot \text{HCF}(q, r) \cdot \text{HCF}(p, r)}$$

$$\text{HCF}(p, q, r) = \frac{p \cdot q \cdot r \cdot \text{LCM}(p, q, r)}{\text{LCM}(p, q) \cdot \text{LCM}(q, r) \cdot \text{LCM}(p, r)}$$



1062CH02

# POLYNOMIALS

# 2

## 2.1 Introduction

In Class IX, you have studied polynomials in one variable and their degrees. Recall that if  $p(x)$  is a polynomial in  $x$ , the highest power of  $x$  in  $p(x)$  is called **the degree of the polynomial**  $p(x)$ . For example,  $4x + 2$  is a polynomial in the variable  $x$  of degree 1,  $2y^2 - 3y + 4$  is a polynomial in the variable  $y$  of degree 2,  $5x^3 - 4x^2 + x - \sqrt{2}$

is a polynomial in the variable  $x$  of degree 3 and  $7u^6 - \frac{3}{2}u^4 + 4u^2 + u - 8$  is a polynomial

in the variable  $u$  of degree 6. Expressions like  $\frac{1}{x-1}$ ,  $\sqrt{x} + 2$ ,  $\frac{1}{x^2 + 2x + 3}$  etc., are not polynomials.

A polynomial of degree 1 is called a **linear polynomial**. For example,  $2x - 3$ ,  $\sqrt{3}x + 5$ ,  $y + \sqrt{2}$ ,  $x - \frac{2}{11}$ ,  $3z + 4$ ,  $\frac{2}{3}u + 1$ , etc., are all linear polynomials. Polynomials such as  $2x + 5 - x^2$ ,  $x^3 + 1$ , etc., are not linear polynomials.

A polynomial of degree 2 is called a **quadratic polynomial**. The name 'quadratic' has been derived from the word 'quadrate', which means 'square'.  $2x^2 + 3x - \frac{2}{5}$ ,

$y^2 - 2$ ,  $2 - x^2 + \sqrt{3}x$ ,  $\frac{u}{3} - 2u^2 + 5$ ,  $\sqrt{5}v^2 - \frac{2}{3}v$ ,  $4z^2 + \frac{1}{7}$  are some examples of quadratic polynomials (whose coefficients are real numbers). More generally, any quadratic polynomial in  $x$  is of the form  $ax^2 + bx + c$ , where  $a, b, c$  are real numbers and  $a \neq 0$ . A polynomial of degree 3 is called a **cubic polynomial**. Some examples of

a cubic polynomial are  $2 - x^3$ ,  $x^3$ ,  $\sqrt{2}x^3$ ,  $3 - x^2 + x^3$ ,  $3x^3 - 2x^2 + x - 1$ . In fact, the most general form of a cubic polynomial is

$$ax^3 + bx^2 + cx + d,$$

where,  $a, b, c, d$  are real numbers and  $a \neq 0$ .

Now consider the polynomial  $p(x) = x^2 - 3x - 4$ . Then, putting  $x = 2$  in the polynomial, we get  $p(2) = 2^2 - 3 \times 2 - 4 = -6$ . The value  $-6$ , obtained by replacing  $x$  by 2 in  $x^2 - 3x - 4$ , is the value of  $x^2 - 3x - 4$  at  $x = 2$ . Similarly,  $p(0)$  is the value of  $p(x)$  at  $x = 0$ , which is  $-4$ .

If  $p(x)$  is a polynomial in  $x$ , and if  $k$  is any real number, then the value obtained by replacing  $x$  by  $k$  in  $p(x)$ , is called **the value of  $p(x)$  at  $x = k$** , and is denoted by  $p(k)$ .

What is the value of  $p(x) = x^2 - 3x - 4$  at  $x = -1$ ? We have :

$$p(-1) = (-1)^2 - \{3 \times (-1)\} - 4 = 0$$

Also, note that  $p(4) = 4^2 - (3 \times 4) - 4 = 0$ .

As  $p(-1) = 0$  and  $p(4) = 0$ ,  $-1$  and  $4$  are called the zeroes of the quadratic polynomial  $x^2 - 3x - 4$ . More generally, a real number  $k$  is said to be a **zero of a polynomial  $p(x)$** , if  $p(k) = 0$ .

You have already studied in Class IX, how to find the zeroes of a linear polynomial. For example, if  $k$  is a zero of  $p(x) = 2x + 3$ , then  $p(k) = 0$  gives us  $2k + 3 = 0$ , i.e.,  $k = -\frac{3}{2}$ .

In general, if  $k$  is a zero of  $p(x) = ax + b$ , then  $p(k) = ak + b = 0$ , i.e.,  $k = \frac{-b}{a}$ .

So, the zero of the linear polynomial  $ax + b$  is  $\frac{-b}{a} = \frac{-(\text{Constant term})}{\text{Coefficient of } x}$ .

Thus, the zero of a linear polynomial is related to its coefficients. Does this happen in the case of other polynomials too? For example, are the zeroes of a quadratic polynomial also related to its coefficients?

In this chapter, we will try to answer these questions. We will also study the division algorithm for polynomials.

## 2.2 Geometrical Meaning of the Zeroes of a Polynomial

You know that a real number  $k$  is a zero of the polynomial  $p(x)$  if  $p(k) = 0$ . But why are the zeroes of a polynomial so important? To answer this, first we will see the **geometrical** representations of linear and quadratic polynomials and the geometrical meaning of their zeroes.

Consider first a linear polynomial  $ax + b$ ,  $a \neq 0$ . You have studied in Class IX that the graph of  $y = ax + b$  is a straight line. For example, the graph of  $y = 2x + 3$  is a straight line passing through the points  $(-2, -1)$  and  $(2, 7)$ .

$x$	$-2$	$2$
$y = 2x + 3$	$-1$	$7$

From Fig. 2.1, you can see that the graph of  $y = 2x + 3$  intersects the  $x$ -axis mid-way between  $x = -1$  and  $x = -2$ , that is, at the point  $\left(-\frac{3}{2}, 0\right)$ .

You also know that the zero of  $2x + 3$  is  $-\frac{3}{2}$ . Thus, the zero of the polynomial  $2x + 3$  is the  $x$ -coordinate of the point where the graph of  $y = 2x + 3$  intersects the  $x$ -axis.

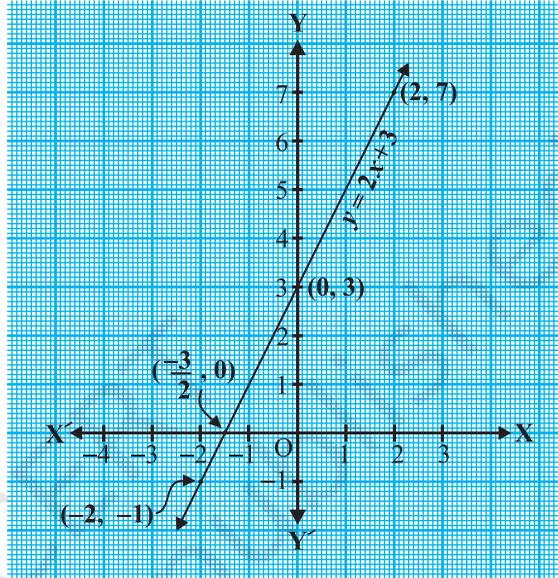


Fig. 2.1

In general, for a linear polynomial  $ax + b$ ,  $a \neq 0$ , the graph of  $y = ax + b$  is a straight line which intersects the  $x$ -axis at exactly one point, namely,  $\left(\frac{-b}{a}, 0\right)$ .

Therefore, the linear polynomial  $ax + b$ ,  $a \neq 0$ , has exactly one zero, namely, the  $x$ -coordinate of the point where the graph of  $y = ax + b$  intersects the  $x$ -axis.

Now, let us look for the geometrical meaning of a zero of a quadratic polynomial. Consider the quadratic polynomial  $x^2 - 3x - 4$ . Let us see what the graph\* of  $y = x^2 - 3x - 4$  looks like. Let us list a few values of  $y = x^2 - 3x - 4$  corresponding to a few values for  $x$  as given in Table 2.1.

\* Plotting of graphs of quadratic or cubic polynomials is not meant to be done by the students, nor is to be evaluated.

Table 2.1

$x$	-2	-1	0	1	2	3	4	5
$y = x^2 - 3x - 4$	6	0	-4	-6	-6	-4	0	6

If we locate the points listed above on a graph paper and draw the graph, it will actually look like the one given in Fig. 2.2.

In fact, for any quadratic polynomial  $ax^2 + bx + c$ ,  $a \neq 0$ , the graph of the corresponding equation  $y = ax^2 + bx + c$  has one of the two shapes either open upwards like  $\cup$  or open downwards like  $\cap$  depending on whether  $a > 0$  or  $a < 0$ . (These curves are called **parabolas**.)

You can see from Table 2.1 that -1 and 4 are zeroes of the quadratic polynomial. Also note from Fig. 2.2 that -1 and 4 are the  $x$ -coordinates of the points where the graph of  $y = x^2 - 3x - 4$  intersects the  $x$ -axis. Thus, the zeroes of the quadratic polynomial  $x^2 - 3x - 4$  are  $x$ -coordinates of the points where the graph of  $y = x^2 - 3x - 4$  intersects the  $x$ -axis.

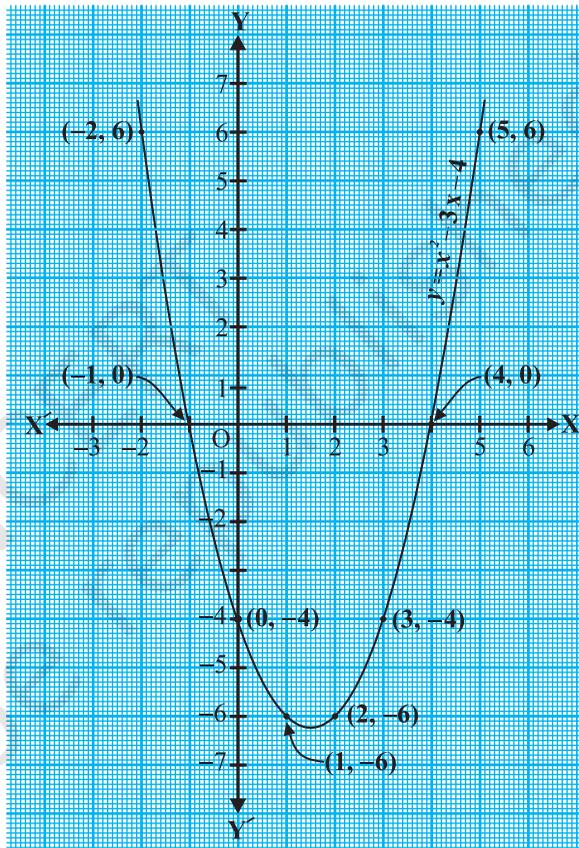


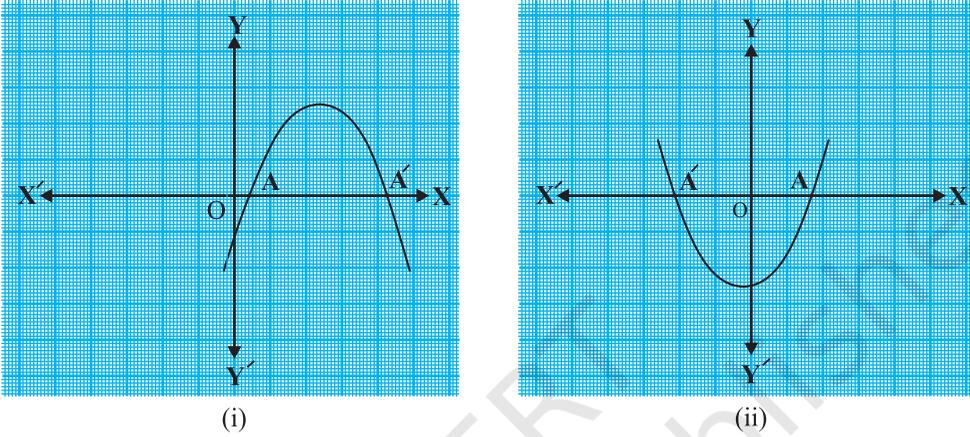
Fig. 2.2

This fact is true for any quadratic polynomial, i.e., the zeroes of a quadratic polynomial  $ax^2 + bx + c$ ,  $a \neq 0$ , are precisely the  $x$ -coordinates of the points where the parabola representing  $y = ax^2 + bx + c$  intersects the  $x$ -axis.

From our observation earlier about the shape of the graph of  $y = ax^2 + bx + c$ , the following three cases can happen:

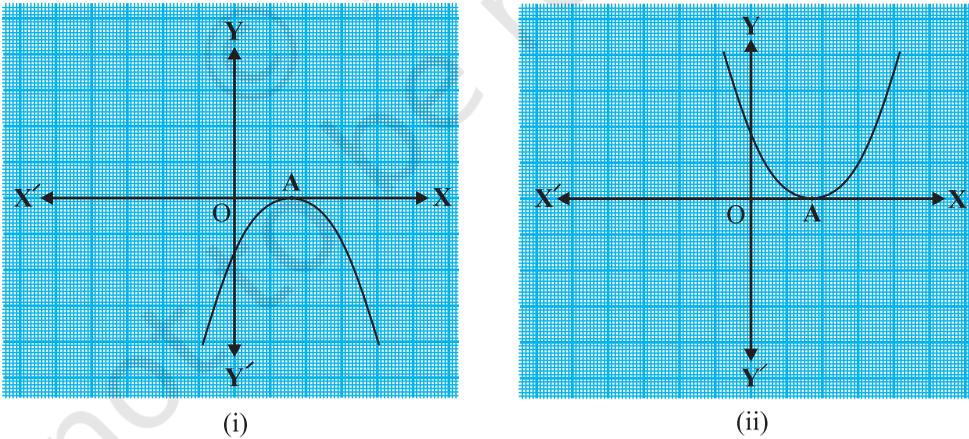
**Case (i) :** Here, the graph cuts  $x$ -axis at two distinct points  $A$  and  $A'$ .

The  $x$ -coordinates of  $A$  and  $A'$  are the **two zeroes** of the quadratic polynomial  $ax^2 + bx + c$  in this case (see Fig. 2.3).



**Fig. 2.3**

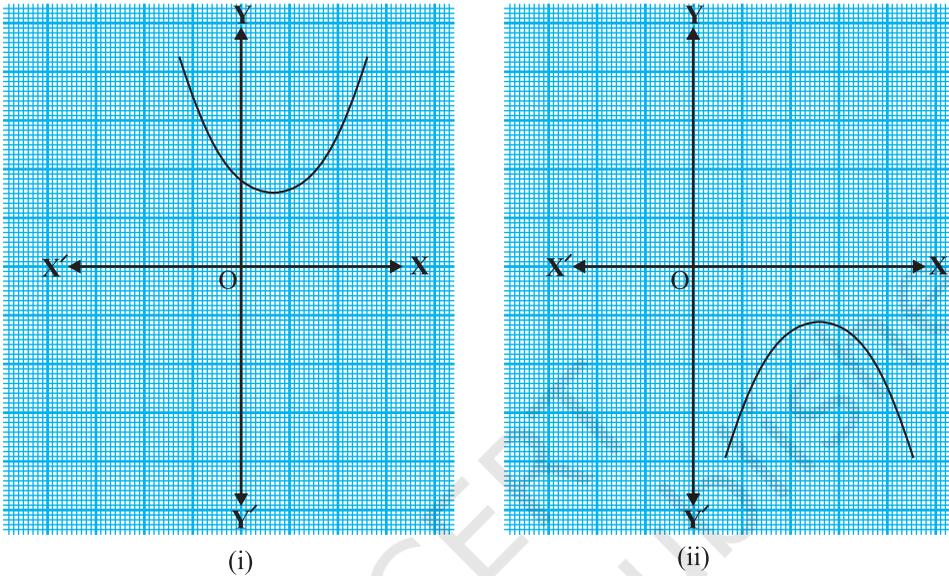
**Case (ii) :** Here, the graph cuts the  $x$ -axis at exactly one point, i.e., at two coincident points. So, the two points  $A$  and  $A'$  of Case (i) coincide here to become one point  $A$  (see Fig. 2.4).



**Fig. 2.4**

The  $x$ -coordinate of  $A$  is the **only zero** for the quadratic polynomial  $ax^2 + bx + c$  in this case.

**Case (iii) :** Here, the graph is either completely above the  $x$ -axis or completely below the  $x$ -axis. So, it does not cut the  $x$ -axis at any point (see Fig. 2.5).



**Fig. 2.5**

So, the quadratic polynomial  $ax^2 + bx + c$  has **no zero** in this case.

So, you can see geometrically that a quadratic polynomial can have either two distinct zeroes or two equal zeroes (i.e., one zero), or no zero. This also means that a polynomial of degree 2 has at most two zeroes.

Now, what do you expect the geometrical meaning of the zeroes of a cubic polynomial to be? Let us find out. Consider the cubic polynomial  $x^3 - 4x$ . To see what the graph of  $y = x^3 - 4x$  looks like, let us list a few values of  $y$  corresponding to a few values for  $x$  as shown in Table 2.2.

**Table 2.2**

$x$	-2	-1	0	1	2
$y = x^3 - 4x$	0	3	0	-3	0

Locating the points of the table on a graph paper and drawing the graph, we see that the graph of  $y = x^3 - 4x$  actually looks like the one given in Fig. 2.6.

We see from the table above that  $-2$ ,  $0$  and  $2$  are zeroes of the cubic polynomial  $x^3 - 4x$ . Observe that  $-2$ ,  $0$  and  $2$  are, in fact, the  $x$ -coordinates of the only points where the graph of  $y = x^3 - 4x$  intersects the  $x$ -axis. Since the curve meets the  $x$ -axis in only these 3 points, their  $x$ -coordinates are the only zeroes of the polynomial.

Let us take a few more examples. Consider the cubic polynomials  $x^3$  and  $x^3 - x^2$ . We draw the graphs of  $y = x^3$  and  $y = x^3 - x^2$  in Fig. 2.7 and Fig. 2.8 respectively.

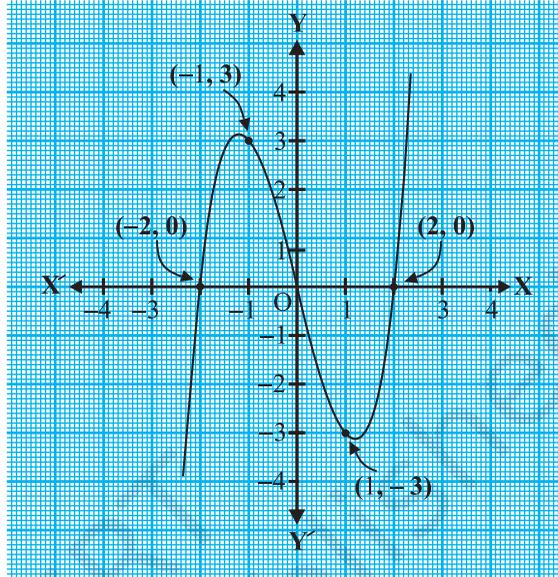


Fig. 2.6

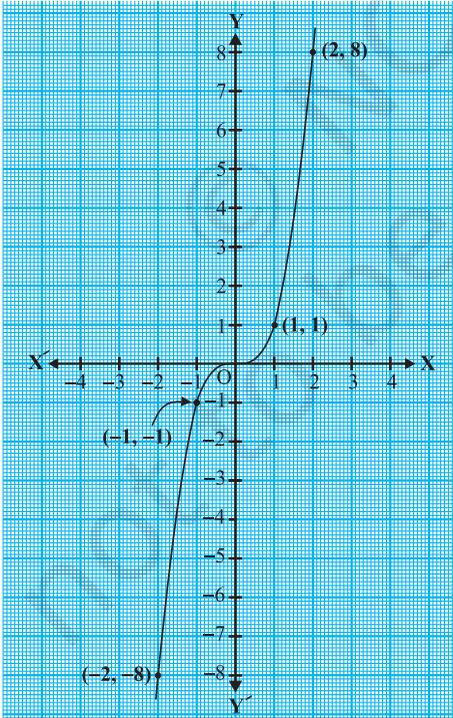


Fig. 2.7

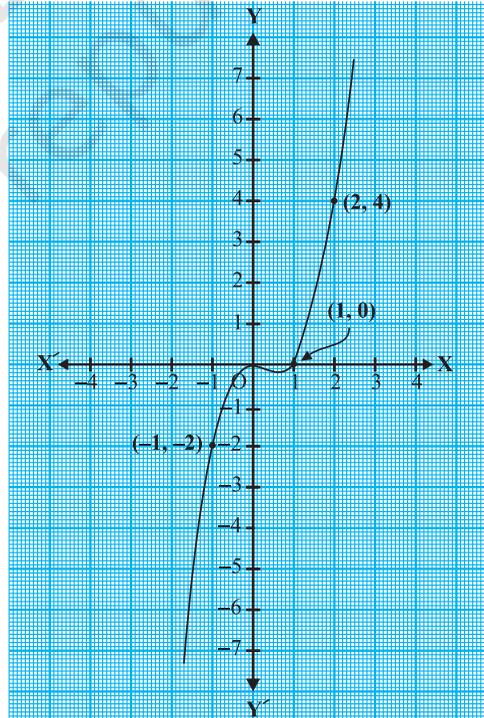


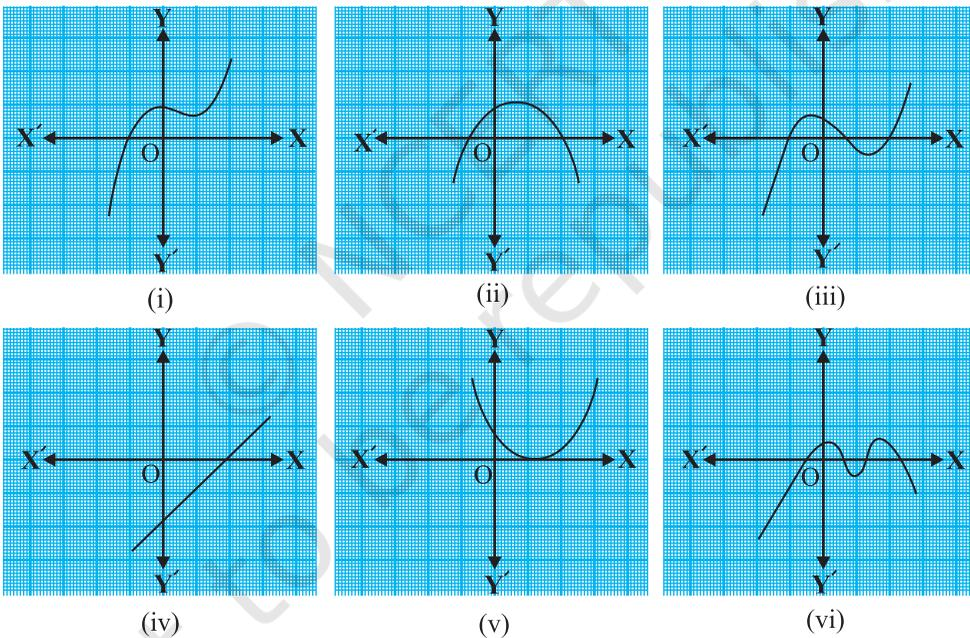
Fig. 2.8

Note that 0 is the only zero of the polynomial  $x^3$ . Also, from Fig. 2.7, you can see that 0 is the  $x$ -coordinate of the only point where the graph of  $y = x^3$  intersects the  $x$ -axis. Similarly, since  $x^3 - x^2 = x^2(x - 1)$ , 0 and 1 are the only zeroes of the polynomial  $x^3 - x^2$ . Also, from Fig. 2.8, these values are the  $x$ -coordinates of the only points where the graph of  $y = x^3 - x^2$  intersects the  $x$ -axis.

From the examples above, we see that there are at most 3 zeroes for any cubic polynomial. In other words, any polynomial of degree 3 can have at most three zeroes.

**Remark :** In general, given a polynomial  $p(x)$  of degree  $n$ , the graph of  $y = p(x)$  intersects the  $x$ -axis at at most  $n$  points. Therefore, a polynomial  $p(x)$  of degree  $n$  has at most  $n$  zeroes.

**Example 1 :** Look at the graphs in Fig. 2.9 given below. Each is the graph of  $y = p(x)$ , where  $p(x)$  is a polynomial. For each of the graphs, find the number of zeroes of  $p(x)$ .



**Fig. 2.9**

**Solution :**

- (i) The number of zeroes is 1 as the graph intersects the  $x$ -axis at one point only.
- (ii) The number of zeroes is 2 as the graph intersects the  $x$ -axis at two points.
- (iii) The number of zeroes is 3. (Why?)

- (iv) The number of zeroes is 1. (Why?)  
 (v) The number of zeroes is 1. (Why?)  
 (vi) The number of zeroes is 4. (Why?)

### EXERCISE 2.1

1. The graphs of  $y = p(x)$  are given in Fig. 2.10 below, for some polynomials  $p(x)$ . Find the number of zeroes of  $p(x)$ , in each case.

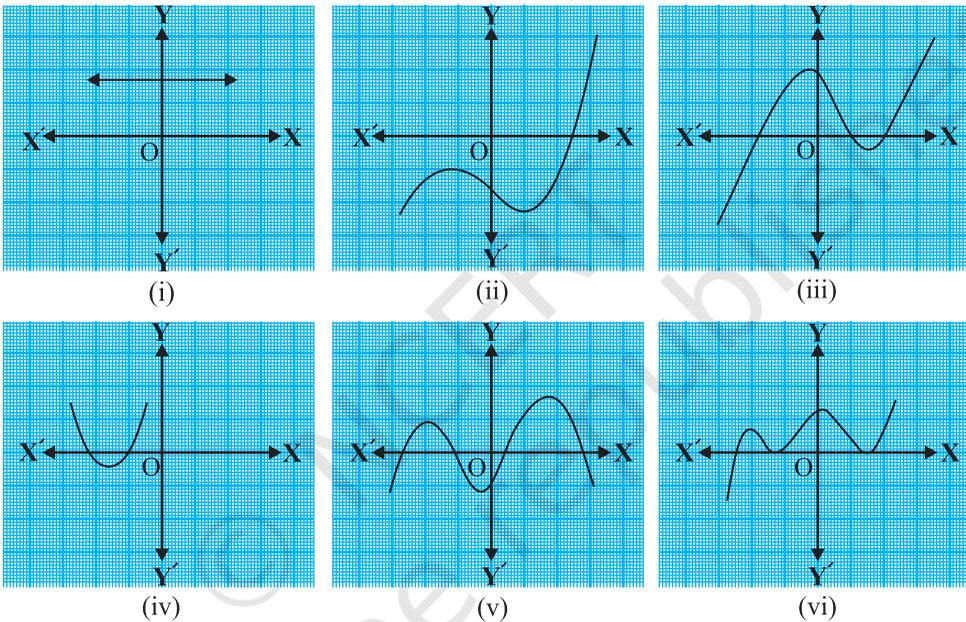


Fig. 2.10

### 2.3 Relationship between Zeroes and Coefficients of a Polynomial

You have already seen that zero of a linear polynomial  $ax + b$  is  $-\frac{b}{a}$ . We will now try to answer the question raised in Section 2.1 regarding the relationship between zeroes and coefficients of a quadratic polynomial. For this, let us take a quadratic polynomial, say  $p(x) = 2x^2 - 8x + 6$ . In Class IX, you have learnt how to factorise quadratic polynomials by splitting the middle term. So, here we need to split the middle term ' $-8x$ ' as a sum of two terms, whose product is  $6 \times 2x^2 = 12x^2$ . So, we write

$$\begin{aligned} 2x^2 - 8x + 6 &= 2x^2 - 6x - 2x + 6 = 2x(x - 3) - 2(x - 3) \\ &= (2x - 2)(x - 3) = 2(x - 1)(x - 3) \end{aligned}$$

So, the value of  $p(x) = 2x^2 - 8x + 6$  is zero when  $x - 1 = 0$  or  $x - 3 = 0$ , i.e., when  $x = 1$  or  $x = 3$ . So, the zeroes of  $2x^2 - 8x + 6$  are 1 and 3. Observe that :

$$\text{Sum of its zeroes} = 1 + 3 = 4 = \frac{-(-8)}{2} = \frac{-(\text{Coefficient of } x)}{\text{Coefficient of } x^2}$$

$$\text{Product of its zeroes} = 1 \times 3 = 3 = \frac{6}{2} = \frac{\text{Constant term}}{\text{Coefficient of } x^2}$$

Let us take one more quadratic polynomial, say,  $p(x) = 3x^2 + 5x - 2$ . By the method of splitting the middle term,

$$\begin{aligned} 3x^2 + 5x - 2 &= 3x^2 + 6x - x - 2 = 3x(x + 2) - 1(x + 2) \\ &= (3x - 1)(x + 2) \end{aligned}$$

Hence, the value of  $3x^2 + 5x - 2$  is zero when either  $3x - 1 = 0$  or  $x + 2 = 0$ , i.e., when  $x = \frac{1}{3}$  or  $x = -2$ . So, the zeroes of  $3x^2 + 5x - 2$  are  $\frac{1}{3}$  and  $-2$ . Observe that :

$$\text{Sum of its zeroes} = \frac{1}{3} + (-2) = \frac{-5}{3} = \frac{-(\text{Coefficient of } x)}{\text{Coefficient of } x^2}$$

$$\text{Product of its zeroes} = \frac{1}{3} \times (-2) = \frac{-2}{3} = \frac{\text{Constant term}}{\text{Coefficient of } x^2}$$

In general, if  $\alpha^*$  and  $\beta^*$  are the zeroes of the quadratic polynomial  $p(x) = ax^2 + bx + c$ ,  $a \neq 0$ , then you know that  $x - \alpha$  and  $x - \beta$  are the factors of  $p(x)$ . Therefore,

$$\begin{aligned} ax^2 + bx + c &= k(x - \alpha)(x - \beta), \text{ where } k \text{ is a constant} \\ &= k[x^2 - (\alpha + \beta)x + \alpha\beta] \\ &= kx^2 - k(\alpha + \beta)x + k\alpha\beta \end{aligned}$$

Comparing the coefficients of  $x^2$ ,  $x$  and constant terms on both the sides, we get

$$a = k, b = -k(\alpha + \beta) \text{ and } c = k\alpha\beta.$$

This gives 
$$\alpha + \beta = \frac{-b}{a},$$

$$\alpha\beta = \frac{c}{a}$$

\*  $\alpha, \beta$  are Greek letters pronounced as 'alpha' and 'beta' respectively. We will use later one more letter ' $\gamma$ ' pronounced as 'gamma'.

i.e., 
$$\text{sum of zeroes} = \alpha + \beta = -\frac{b}{a} = \frac{-(\text{Coefficient of } x)}{\text{Coefficient of } x^2},$$

$$\text{product of zeroes} = \alpha\beta = \frac{c}{a} = \frac{\text{Constant term}}{\text{Coefficient of } x^2}.$$

Let us consider some examples.

**Example 2 :** Find the zeroes of the quadratic polynomial  $x^2 + 7x + 10$ , and verify the relationship between the zeroes and the coefficients.

**Solution :** We have

$$x^2 + 7x + 10 = (x + 2)(x + 5)$$

So, the value of  $x^2 + 7x + 10$  is zero when  $x + 2 = 0$  or  $x + 5 = 0$ , i.e., when  $x = -2$  or  $x = -5$ . Therefore, the zeroes of  $x^2 + 7x + 10$  are  $-2$  and  $-5$ . Now,

$$\text{sum of zeroes} = -2 + (-5) = -7 = \frac{-7}{1} = \frac{-(\text{Coefficient of } x)}{\text{Coefficient of } x^2},$$

$$\text{product of zeroes} = (-2) \times (-5) = 10 = \frac{10}{1} = \frac{\text{Constant term}}{\text{Coefficient of } x^2}.$$

**Example 3 :** Find the zeroes of the polynomial  $x^2 - 3$  and verify the relationship between the zeroes and the coefficients.

**Solution :** Recall the identity  $a^2 - b^2 = (a - b)(a + b)$ . Using it, we can write:

$$x^2 - 3 = (x - \sqrt{3})(x + \sqrt{3})$$

So, the value of  $x^2 - 3$  is zero when  $x = \sqrt{3}$  or  $x = -\sqrt{3}$ .

Therefore, the zeroes of  $x^2 - 3$  are  $\sqrt{3}$  and  $-\sqrt{3}$ .

Now,

$$\text{sum of zeroes} = \sqrt{3} - \sqrt{3} = 0 = \frac{-(\text{Coefficient of } x)}{\text{Coefficient of } x^2},$$

$$\text{product of zeroes} = (\sqrt{3})(-\sqrt{3}) = -3 = \frac{-3}{1} = \frac{\text{Constant term}}{\text{Coefficient of } x^2}.$$

**Example 4 :** Find a quadratic polynomial, the sum and product of whose zeroes are  $-3$  and  $2$ , respectively.

**Solution :** Let the quadratic polynomial be  $ax^2 + bx + c$ , and its zeroes be  $\alpha$  and  $\beta$ . We have

$$\alpha + \beta = -3 = \frac{-b}{a},$$

and 
$$\alpha\beta = 2 = \frac{c}{a}.$$

If  $a = 1$ , then  $b = 3$  and  $c = 2$ .

So, one quadratic polynomial which fits the given conditions is  $x^2 + 3x + 2$ .

You can check that any other quadratic polynomial that fits these conditions will be of the form  $k(x^2 + 3x + 2)$ , where  $k$  is real.

Let us now look at cubic polynomials. Do you think a similar relation holds between the zeroes of a cubic polynomial and its coefficients?

Let us consider  $p(x) = 2x^3 - 5x^2 - 14x + 8$ .

You can check that  $p(x) = 0$  for  $x = 4, -2, \frac{1}{2}$ . Since  $p(x)$  can have at most three zeroes, these are the zeroes of  $2x^3 - 5x^2 - 14x + 8$ . Now,

$$\text{sum of the zeroes} = 4 + (-2) + \frac{1}{2} = \frac{5}{2} = \frac{-(-5)}{2} = \frac{-(\text{Coefficient of } x^2)}{\text{Coefficient of } x^3},$$

$$\text{product of the zeroes} = 4 \times (-2) \times \frac{1}{2} = -4 = \frac{-8}{2} = \frac{-\text{Constant term}}{\text{Coefficient of } x^3}.$$

However, there is one more relationship here. Consider the sum of the products of the zeroes taken two at a time. We have

$$\begin{aligned} & \{4 \times (-2)\} + \left\{(-2) \times \frac{1}{2}\right\} + \left\{\frac{1}{2} \times 4\right\} \\ &= -8 - 1 + 2 = -7 = \frac{-14}{2} = \frac{\text{Coefficient of } x}{\text{Coefficient of } x^3}. \end{aligned}$$

In general, it can be proved that if  $\alpha, \beta, \gamma$  are the zeroes of the cubic polynomial  $ax^3 + bx^2 + cx + d$ , then

$$\alpha + \beta + \gamma = \frac{-b}{a},$$

$$\alpha\beta + \beta\gamma + \gamma\alpha = \frac{c}{a},$$

$$\alpha\beta\gamma = \frac{-d}{a}.$$

Let us consider an example.

**Example 5\*** : Verify that 3, -1,  $-\frac{1}{3}$  are the zeroes of the cubic polynomial  $p(x) = 3x^3 - 5x^2 - 11x - 3$ , and then verify the relationship between the zeroes and the coefficients.

**Solution** : Comparing the given polynomial with  $ax^3 + bx^2 + cx + d$ , we get

$a = 3, b = -5, c = -11, d = -3$ . Further

$$p(3) = 3 \times 3^3 - (5 \times 3^2) - (11 \times 3) - 3 = 81 - 45 - 33 - 3 = 0,$$

$$p(-1) = 3 \times (-1)^3 - 5 \times (-1)^2 - 11 \times (-1) - 3 = -3 - 5 + 11 - 3 = 0,$$

$$p\left(-\frac{1}{3}\right) = 3 \times \left(-\frac{1}{3}\right)^3 - 5 \times \left(-\frac{1}{3}\right)^2 - 11 \times \left(-\frac{1}{3}\right) - 3,$$

$$= -\frac{1}{9} - \frac{5}{9} + \frac{11}{3} - 3 = -\frac{2}{3} + \frac{2}{3} = 0$$

Therefore, 3, -1 and  $-\frac{1}{3}$  are the zeroes of  $3x^3 - 5x^2 - 11x - 3$ .

So, we take  $\alpha = 3, \beta = -1$  and  $\gamma = -\frac{1}{3}$ .

Now,

$$\alpha + \beta + \gamma = 3 + (-1) + \left(-\frac{1}{3}\right) = 2 - \frac{1}{3} = \frac{5}{3} = \frac{-(-5)}{3} = \frac{-b}{a},$$

$$\alpha\beta + \beta\gamma + \gamma\alpha = 3 \times (-1) + (-1) \times \left(-\frac{1}{3}\right) + \left(-\frac{1}{3}\right) \times 3 = -3 + \frac{1}{3} - 1 = \frac{-11}{3} = \frac{c}{a},$$

$$\alpha\beta\gamma = 3 \times (-1) \times \left(-\frac{1}{3}\right) = 1 = \frac{-(-3)}{3} = \frac{-d}{a}.$$

\* Not from the examination point of view.

## EXERCISE 2.2

1. Find the zeroes of the following quadratic polynomials and verify the relationship between the zeroes and the coefficients.

(i)  $x^2 - 2x - 8$

(ii)  $4s^2 - 4s + 1$

(iii)  $6x^2 - 3 - 7x$

(iv)  $4u^2 + 8u$

(v)  $t^2 - 15$

(vi)  $3x^2 - x - 4$

2. Find a quadratic polynomial each with the given numbers as the sum and product of its zeroes respectively.

(i)  $\frac{1}{4}, -1$

(ii)  $\sqrt{2}, \frac{1}{3}$

(iii)  $0, \sqrt{5}$

(iv)  $1, 1$

(v)  $-\frac{1}{4}, \frac{1}{4}$

(vi)  $4, 1$

## 2.4 Division Algorithm for Polynomials

You know that a cubic polynomial has at most three zeroes. However, if you are given only one zero, can you find the other two? For this, let us consider the cubic polynomial  $x^3 - 3x^2 - x + 3$ . If we tell you that one of its zeroes is 1, then you know that  $x - 1$  is a factor of  $x^3 - 3x^2 - x + 3$ . So, you can divide  $x^3 - 3x^2 - x + 3$  by  $x - 1$ , as you have learnt in Class IX, to get the quotient  $x^2 - 2x - 3$ .

Next, you could get the factors of  $x^2 - 2x - 3$ , by splitting the middle term, as  $(x + 1)(x - 3)$ . This would give you

$$\begin{aligned} x^3 - 3x^2 - x + 3 &= (x - 1)(x^2 - 2x - 3) \\ &= (x - 1)(x + 1)(x - 3) \end{aligned}$$

So, all the three zeroes of the cubic polynomial are now known to you as 1, -1, 3.

Let us discuss the method of dividing one polynomial by another in some detail. Before noting the steps formally, consider an example.

**Example 6 :** Divide  $2x^2 + 3x + 1$  by  $x + 2$ .

**Solution :** Note that we stop the division process when either the remainder is zero or its degree is less than the degree of the divisor. So, here the quotient is  $2x - 1$  and the remainder is 3. Also,

$$\begin{aligned} (2x - 1)(x + 2) + 3 &= 2x^2 + 3x - 2 + 3 = 2x^2 + 3x + 1 \\ \text{i.e., } 2x^2 + 3x + 1 &= (x + 2)(2x - 1) + 3 \end{aligned}$$

Therefore, Dividend = Divisor  $\times$  Quotient + Remainder

Let us now extend this process to divide a polynomial by a quadratic polynomial.

$$\begin{array}{r} \phantom{x + 2} \overline{2x - 1} \\ x + 2 \overline{) 2x^2 + 3x + 1} \\ \underline{2x^2 + 4x} \phantom{+ 1} \\ -x + 1 \\ \underline{-x - 2} \\ \phantom{-x - 2} 3 \end{array}$$

**Example 7 :** Divide  $3x^3 + x^2 + 2x + 5$  by  $1 + 2x + x^2$ .

**Solution :** We first arrange the terms of the dividend and the divisor in the decreasing order of their degrees. Recall that arranging the terms in this order is called writing the polynomials in standard form. In this example, the dividend is already in standard form, and the divisor, in standard form, is  $x^2 + 2x + 1$ .

$$\begin{array}{r}
 \phantom{x^2 + 2x + 1} \overline{) 3x^3 + x^2 + 2x + 5} \\
 \underline{3x^3 + 6x^2 + 3x} \phantom{+ 5} \\
 -5x^2 - x + 5 \\
 \underline{-5x^2 - 10x - 5} \\
 9x + 10
 \end{array}$$

**Step 1 :** To obtain the first term of the quotient, divide the highest degree term of the dividend (i.e.,  $3x^3$ ) by the highest degree term of the divisor (i.e.,  $x^2$ ). This is  $3x$ . Then carry out the division process. What remains is  $-5x^2 - x + 5$ .

**Step 2 :** Now, to obtain the second term of the quotient, divide the highest degree term of the new dividend (i.e.,  $-5x^2$ ) by the highest degree term of the divisor (i.e.,  $x^2$ ). This gives  $-5$ . Again carry out the division process with  $-5x^2 - x + 5$ .

**Step 3 :** What remains is  $9x + 10$ . Now, the degree of  $9x + 10$  is less than the degree of the divisor  $x^2 + 2x + 1$ . So, we cannot continue the division any further.

So, the quotient is  $3x - 5$  and the remainder is  $9x + 10$ . Also,

$$\begin{aligned}
 (x^2 + 2x + 1) \times (3x - 5) + (9x + 10) &= 3x^3 + 6x^2 + 3x - 5x^2 - 10x - 5 + 9x + 10 \\
 &= 3x^3 + x^2 + 2x + 5
 \end{aligned}$$

Here again, we see that

$$\text{Dividend} = \text{Divisor} \times \text{Quotient} + \text{Remainder}$$

What we are applying here is an algorithm which is similar to Euclid's division algorithm that you studied in Chapter 1.

This says that

**If  $p(x)$  and  $g(x)$  are any two polynomials with  $g(x) \neq 0$ , then we can find polynomials  $q(x)$  and  $r(x)$  such that**

$$p(x) = g(x) \times q(x) + r(x),$$

where  $r(x) = 0$  or degree of  $r(x) <$  degree of  $g(x)$ .

This result is known as the **Division Algorithm** for polynomials.

Let us now take some examples to illustrate its use.

**Example 8 :** Divide  $3x^2 - x^3 - 3x + 5$  by  $x - 1 - x^2$ , and verify the division algorithm.

**Solution :** Note that the given polynomials are not in standard form. To carry out division, we first write both the dividend and divisor in decreasing orders of their degrees.

So, dividend =  $-x^3 + 3x^2 - 3x + 5$  and divisor =  $-x^2 + x - 1$ .

Division process is shown on the right side.

We stop here since degree (3) = 0 < 2 = degree ( $-x^2 + x - 1$ ).

So, quotient =  $x - 2$ , remainder = 3.

Now,

Divisor  $\times$  Quotient + Remainder

$$\begin{aligned} &= (-x^2 + x - 1)(x - 2) + 3 \\ &= -x^3 + x^2 - x + 2x^2 - 2x + 2 + 3 \\ &= -x^3 + 3x^2 - 3x + 5 \\ &= \text{Dividend} \end{aligned}$$

In this way, the division algorithm is verified.

**Example 9 :** Find all the zeroes of  $2x^4 - 3x^3 - 3x^2 + 6x - 2$ , if you know that two of its zeroes are  $\sqrt{2}$  and  $-\sqrt{2}$ .

**Solution :** Since two zeroes are  $\sqrt{2}$  and  $-\sqrt{2}$ ,  $(x - \sqrt{2})(x + \sqrt{2}) = x^2 - 2$  is a factor of the given polynomial. Now, we divide the given polynomial by  $x^2 - 2$ .

$$\begin{array}{r} 2x^2 - 3x + 1 \\ x^2 - 2 \overline{) 2x^4 - 3x^3 - 3x^2 + 6x - 2} \\ \underline{-2x^4 \phantom{- 3x^3} + 4x^2 \phantom{+ 6x} - 2} \\ -3x^3 + x^2 + 6x - 2 \\ \underline{-3x^3 \phantom{+ x^2} + 6x} \\ x^2 - 2 \\ \underline{x^2 \phantom{- 2} - 2} \\ - \phantom{x^2} + \phantom{- 2} \\ \underline{\phantom{x^2} \phantom{+} \phantom{- 2} 0} \end{array}$$

First term of quotient is  $\frac{2x^4}{x^2} = 2x^2$

Second term of quotient is  $\frac{-3x^3}{x^2} = -3x$

Third term of quotient is  $\frac{x^2}{x^2} = 1$

$$\begin{array}{r} x - 2 \\ -x^2 + x - 1 \overline{) -x^3 + 3x^2 - 3x + 5} \\ \underline{-x^3 + x^2 - x} \\ 2x^2 - 2x + 5 \\ \underline{2x^2 - 2x + 2} \\ 3 \end{array}$$

So,  $2x^4 - 3x^3 - 3x^2 + 6x - 2 = (x^2 - 2)(2x^2 - 3x + 1)$ .

Now, by splitting  $-3x$ , we factorise  $2x^2 - 3x + 1$  as  $(2x - 1)(x - 1)$ . So, its zeroes are given by  $x = \frac{1}{2}$  and  $x = 1$ . Therefore, the zeroes of the given polynomial are

$\sqrt{2}$ ,  $-\sqrt{2}$ ,  $\frac{1}{2}$ , and  $1$ .

### EXERCISE 2.3

- Divide the polynomial  $p(x)$  by the polynomial  $g(x)$  and find the quotient and remainder in each of the following :
  - $p(x) = x^3 - 3x^2 + 5x - 3$ ,  $g(x) = x^2 - 2$
  - $p(x) = x^4 - 3x^2 + 4x + 5$ ,  $g(x) = x^2 + 1 - x$
  - $p(x) = x^4 - 5x + 6$ ,  $g(x) = 2 - x^2$
- Check whether the first polynomial is a factor of the second polynomial by dividing the second polynomial by the first polynomial:
  - $t^2 - 3$ ,  $2t^4 + 3t^3 - 2t^2 - 9t - 12$
  - $x^2 + 3x + 1$ ,  $3x^4 + 5x^3 - 7x^2 + 2x + 2$
  - $x^3 - 3x + 1$ ,  $x^5 - 4x^3 + x^2 + 3x + 1$
- Obtain all other zeroes of  $3x^4 + 6x^3 - 2x^2 - 10x - 5$ , if two of its zeroes are  $\sqrt{\frac{5}{3}}$  and  $-\sqrt{\frac{5}{3}}$ .
- On dividing  $x^3 - 3x^2 + x + 2$  by a polynomial  $g(x)$ , the quotient and remainder were  $x - 2$  and  $-2x + 4$ , respectively. Find  $g(x)$ .
- Give examples of polynomials  $p(x)$ ,  $g(x)$ ,  $q(x)$  and  $r(x)$ , which satisfy the division algorithm and
  - $\deg p(x) = \deg q(x)$
  - $\deg q(x) = \deg r(x)$
  - $\deg r(x) = 0$

### EXERCISE 2.4 (Optional)\*

- Verify that the numbers given alongside of the cubic polynomials below are their zeroes. Also verify the relationship between the zeroes and the coefficients in each case:
  - $2x^3 + x^2 - 5x + 2$ ;  $\frac{1}{2}$ ,  $1$ ,  $-2$
  - $x^3 - 4x^2 + 5x - 2$ ;  $2$ ,  $1$ ,  $1$
- Find a cubic polynomial with the sum, sum of the product of its zeroes taken two at a time, and the product of its zeroes as  $2$ ,  $-7$ ,  $-14$  respectively.

\*These exercises are not from the examination point of view.

3. If the zeroes of the polynomial  $x^3 - 3x^2 + x + 1$  are  $a - b$ ,  $a$ ,  $a + b$ , find  $a$  and  $b$ .
4. If two zeroes of the polynomial  $x^4 - 6x^3 - 26x^2 + 138x - 35$  are  $2 \pm \sqrt{3}$ , find other zeroes.
5. If the polynomial  $x^4 - 6x^3 + 16x^2 - 25x + 10$  is divided by another polynomial  $x^2 - 2x + k$ , the remainder comes out to be  $x + a$ , find  $k$  and  $a$ .

## 2.5 Summary

In this chapter, you have studied the following points:

1. Polynomials of degrees 1, 2 and 3 are called linear, quadratic and cubic polynomials respectively.
2. A quadratic polynomial in  $x$  with real coefficients is of the form  $ax^2 + bx + c$ , where  $a, b, c$  are real numbers with  $a \neq 0$ .
3. The zeroes of a polynomial  $p(x)$  are precisely the  $x$ -coordinates of the points, where the graph of  $y = p(x)$  intersects the  $x$ -axis.
4. A quadratic polynomial can have at most 2 zeroes and a cubic polynomial can have at most 3 zeroes.
5. If  $\alpha$  and  $\beta$  are the zeroes of the quadratic polynomial  $ax^2 + bx + c$ , then

$$\alpha + \beta = -\frac{b}{a}, \quad \alpha\beta = \frac{c}{a}.$$

6. If  $\alpha, \beta, \gamma$  are the zeroes of the cubic polynomial  $ax^3 + bx^2 + cx + d$ , then

$$\alpha + \beta + \gamma = -\frac{b}{a},$$

$$\alpha\beta + \beta\gamma + \gamma\alpha = \frac{c}{a},$$

$$\text{and} \quad \alpha\beta\gamma = \frac{-d}{a}.$$

7. The division algorithm states that given any polynomial  $p(x)$  and any non-zero polynomial  $g(x)$ , there are polynomials  $q(x)$  and  $r(x)$  such that

$$p(x) = g(x)q(x) + r(x),$$

where  $r(x) = 0$  or  $\text{degree } r(x) < \text{degree } g(x)$ .



1062CH03

# PAIR OF LINEAR EQUATIONS IN TWO VARIABLES

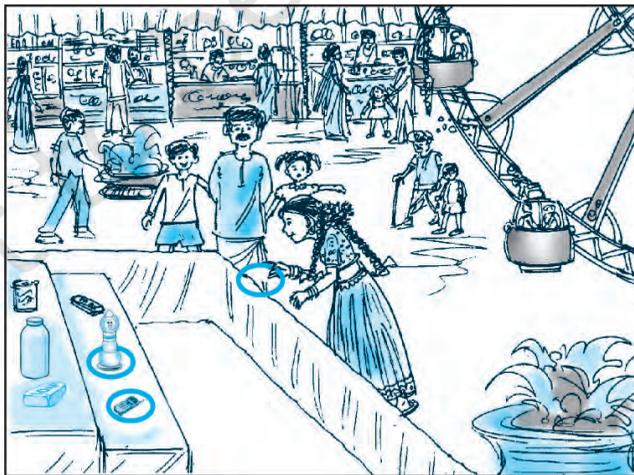
# 3

## 3.1 Introduction

You must have come across situations like the one given below :

Akhila went to a fair in her village. She wanted to enjoy rides on the Giant Wheel and play Hoopla (a game in which you throw a ring on the items kept in a stall, and if the ring covers any object completely, you get it). The number of times she played Hoopla is half the number of rides she had on the Giant Wheel. If each ride costs ₹ 3, and a game of Hoopla costs ₹ 4, how would you find out the number of rides she had and how many times she played Hoopla, provided she spent ₹ 20.

May be you will try it by considering different cases. If she has one ride, is it possible? Is it possible to have two rides? And so on. Or you may use the knowledge of Class IX, to represent such situations as linear equations in two variables.



Let us try this approach.

Denote the number of rides that Akhila had by  $x$ , and the number of times she played Hoopla by  $y$ . Now the situation can be represented by the two equations:

$$y = \frac{1}{2}x \quad (1)$$

$$3x + 4y = 20 \quad (2)$$

Can we find the solutions of this pair of equations? There are several ways of finding these, which we will study in this chapter.

### 3.2 Pair of Linear Equations in Two Variables

Recall, from Class IX, that the following are examples of linear equations in two variables:

$$2x + 3y = 5$$

$$x - 2y - 3 = 0$$

and

$$x - 0y = 2, \text{ i.e., } x = 2$$

You also know that an equation which can be put in the form  $ax + by + c = 0$ , where  $a$ ,  $b$  and  $c$  are real numbers, and  **$a$  and  $b$  are not both zero**, is called a linear equation in two variables  $x$  and  $y$ . (We often denote the condition  $a$  and  $b$  are not both zero by  $a^2 + b^2 \neq 0$ ). You have also studied that a solution of such an equation is a pair of values, one for  $x$  and the other for  $y$ , which makes the two sides of the equation equal.

For example, let us substitute  $x = 1$  and  $y = 1$  in the left hand side (LHS) of the equation  $2x + 3y = 5$ . Then

$$\text{LHS} = 2(1) + 3(1) = 2 + 3 = 5,$$

which is equal to the right hand side (RHS) of the equation.

Therefore,  $x = 1$  and  $y = 1$  is a solution of the equation  $2x + 3y = 5$ .

Now let us substitute  $x = 1$  and  $y = 7$  in the equation  $2x + 3y = 5$ . Then,

$$\text{LHS} = 2(1) + 3(7) = 2 + 21 = 23$$

which is not equal to the RHS.

Therefore,  $x = 1$  and  $y = 7$  is **not** a solution of the equation.

Geometrically, what does this mean? It means that the point  $(1, 1)$  lies on the line representing the equation  $2x + 3y = 5$ , and the point  $(1, 7)$  does not lie on it. So, **every solution of the equation is a point on the line representing it.**

In fact, this is true for any linear equation, that is, **each solution  $(x, y)$  of a linear equation in two variables,  $ax + by + c = 0$ , corresponds to a point on the line representing the equation, and vice versa.**

Now, consider Equations (1) and (2) given above. These equations, **taken together**, represent the information we have about Akhila at the fair.

These two linear equations are **in the same two variables  $x$  and  $y$** . Equations like these are called a *pair of linear equations in two variables*.

Let us see what such pairs look like algebraically.

The general form for a pair of linear equations in two variables  $x$  and  $y$  is

$$a_1x + b_1y + c_1 = 0$$

and 
$$a_2x + b_2y + c_2 = 0,$$

where  $a_1, b_1, c_1, a_2, b_2, c_2$  are all real numbers and  $a_1^2 + b_1^2 \neq 0, a_2^2 + b_2^2 \neq 0$ .

Some examples of pair of linear equations in two variables are:

$$2x + 3y - 7 = 0 \text{ and } 9x - 2y + 8 = 0$$

$$5x = y \text{ and } -7x + 2y + 3 = 0$$

$$x + y = 7 \text{ and } 17 = y$$

Do you know, what do they look like geometrically?

Recall, that you have studied in Class IX that the geometrical (i.e., graphical) representation of a linear equation in two variables is a straight line. Can you now suggest what a pair of linear equations in two variables will look like, geometrically? There will be two straight lines, both to be considered together.

You have also studied in Class IX that given two lines in a plane, only one of the following three possibilities can happen:

- (i) The two lines will intersect at one point.
- (ii) The two lines will not intersect, i.e., they are parallel.
- (iii) The two lines will be coincident.

We show all these possibilities in Fig. 3.1:

In Fig. 3.1 (a), they intersect.

In Fig. 3.1 (b), they are parallel.

In Fig. 3.1 (c), they are coincident.

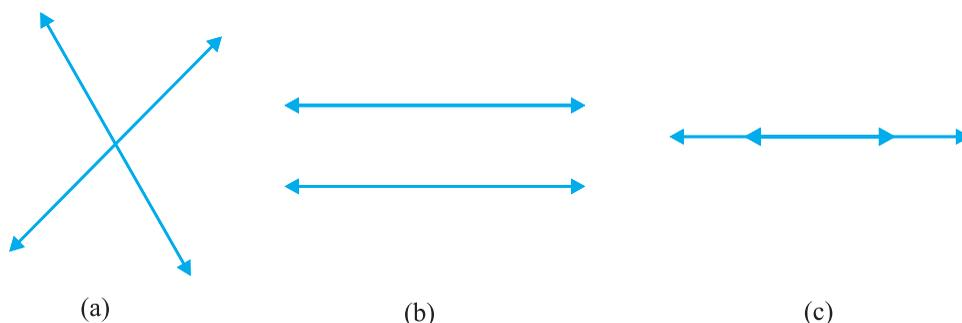


Fig. 3.1

Both ways of representing a pair of linear equations go hand-in-hand—the algebraic and the geometric ways. Let us consider some examples.

**Example 1 :** Let us take the example given in Section 3.1. Akhila goes to a fair with ₹ 20 and wants to have rides on the Giant Wheel and play Hoopla. Represent this situation algebraically and graphically (geometrically).

**Solution :** The pair of equations formed is :

$$y = \frac{1}{2}x$$

i.e.,  $x - 2y = 0$  (1)

$$3x + 4y = 20$$
 (2)

Let us represent these equations graphically. For this, we need at least two solutions for each equation. We give these solutions in Table 3.1.

Table 3.1

$x$	0	2
$y = \frac{x}{2}$	0	1

(i)

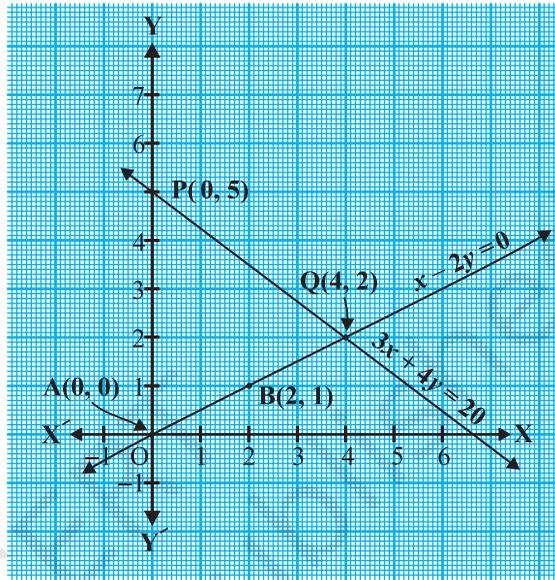
$x$	0	$\frac{20}{3}$	4
$y = \frac{20 - 3x}{4}$	5	0	2

(ii)

Recall from Class IX that there are infinitely many solutions of each linear equation. So each of you can choose any two values, which may not be the ones we have chosen. Can you guess why we have chosen  $x = 0$  in the first equation and in the second equation? When one of the variables is zero, the equation reduces to a linear

equation in one variable, which can be solved easily. For instance, putting  $x = 0$  in Equation (2), we get  $4y = 20$ , i.e.,  $y = 5$ . Similarly, putting  $y = 0$  in Equation (2), we get  $3x = 20$ , i.e.,  $x = \frac{20}{3}$ . But as  $\frac{20}{3}$  is not an integer, it will not be easy to plot exactly on the graph paper. So, we choose  $y = 2$  which gives  $x = 4$ , an integral value.

Plot the points  $A(0, 0)$ ,  $B(2, 1)$  and  $P(0, 5)$ ,  $Q(4, 2)$ , corresponding to the solutions in Table 3.1. Now draw the lines  $AB$  and  $PQ$ , representing the equations  $x - 2y = 0$  and  $3x + 4y = 20$ , as shown in Fig. 3.2.



**Fig. 3.2**

In Fig. 3.2, observe that the two lines representing the two equations are intersecting at the point  $(4, 2)$ . We shall discuss what this means in the next section.

**Example 2 :** Romila went to a stationery shop and purchased 2 pencils and 3 erasers for ₹ 9. Her friend Sonali saw the new variety of pencils and erasers with Romila, and she also bought 4 pencils and 6 erasers of the same kind for ₹ 18. Represent this situation algebraically and graphically.

**Solution :** Let us denote the cost of 1 pencil by ₹  $x$  and one eraser by ₹  $y$ . Then the algebraic representation is given by the following equations:

$$2x + 3y = 9 \quad (1)$$

$$4x + 6y = 18 \quad (2)$$

To obtain the equivalent geometric representation, we find two points on the line representing each equation. That is, we find two solutions of each equation.

These solutions are given below in Table 3.2.

$x$	0	4.5
$y = \frac{9 - 2x}{3}$	3	0

(i)

**Table 3.2**

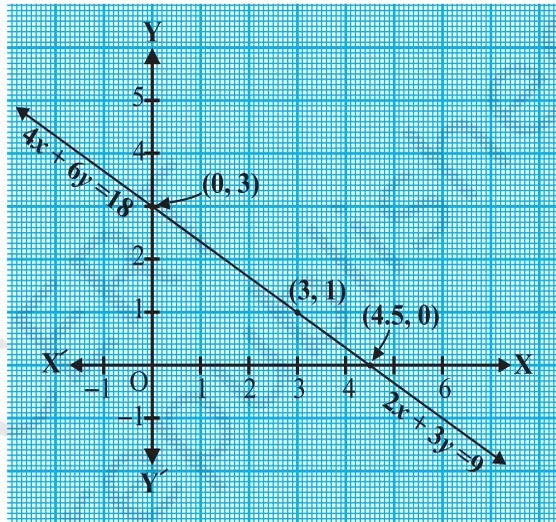
$x$	0	3
$y = \frac{18 - 4x}{6}$	3	1

(ii)

We plot these points in a graph paper and draw the lines. We find that both the lines coincide (see Fig. 3.3). This is so, because, both the equations are equivalent, i.e., one can be derived from the other.

**Example 3 :** Two rails are represented by the equations  $x + 2y - 4 = 0$  and  $2x + 4y - 12 = 0$ . Represent this situation geometrically.

**Solution :** Two solutions of each of the equations :



**Fig. 3.3**

$$x + 2y - 4 = 0 \tag{1}$$

$$2x + 4y - 12 = 0 \tag{2}$$

are given in Table 3.3

**Table 3.3**

$x$	0	4
$y = \frac{4 - x}{2}$	2	0

(i)

$x$	0	6
$y = \frac{12 - 2x}{4}$	3	0

(ii)

To represent the equations graphically, we plot the points R(0, 2) and S(4, 0), to get the line RS and the points P(0, 3) and Q(6, 0) to get the line PQ.

We observe in Fig. 3.4, that the lines do not intersect anywhere, i.e., they are parallel.

So, we have seen several situations which can be represented by a pair of linear equations. We have seen their algebraic and geometric representations. In the next few sections, we will discuss how these representations can be used to look for solutions of the pair of linear equations.

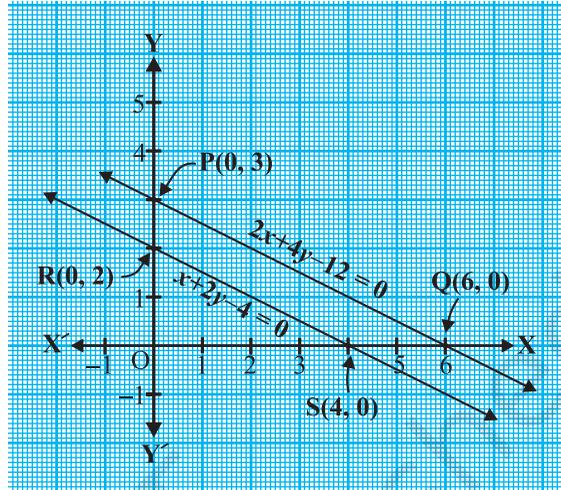


Fig. 3.4

### EXERCISE 3.1

1. Aftab tells his daughter, “Seven years ago, I was seven times as old as you were then. Also, three years from now, I shall be three times as old as you will be.” (Isn’t this interesting?) Represent this situation algebraically and graphically.
2. The coach of a cricket team buys 3 bats and 6 balls for ₹ 3900. Later, she buys another bat and 3 more balls of the same kind for ₹ 1300. Represent this situation algebraically and geometrically.
3. The cost of 2 kg of apples and 1kg of grapes on a day was found to be ₹ 160. After a month, the cost of 4 kg of apples and 2 kg of grapes is ₹ 300. Represent the situation algebraically and geometrically.

### 3.3 Graphical Method of Solution of a Pair of Linear Equations

In the previous section, you have seen how we can graphically represent a pair of linear equations as two lines. You have also seen that the lines may intersect, or may be parallel, or may coincide. Can we solve them in each case? And if so, how? We shall try and answer these questions from the geometrical point of view in this section.

Let us look at the earlier examples one by one.

- In the situation of Example 1, find out how many rides on the Giant Wheel Akhila had, and how many times she played Hoopla.

In Fig. 3.2, you noted that the equations representing the situation are geometrically shown by two lines intersecting at the point (4, 2). Therefore, the

point  $(4, 2)$  lies on the lines represented by both the equations  $x - 2y = 0$  and  $3x + 4y = 20$ . And this is the only common point.

Let us verify algebraically that  $x = 4, y = 2$  is a solution of the given pair of equations. Substituting the values of  $x$  and  $y$  in each equation, we get  $4 - 2 \times 2 = 0$  and  $3(4) + 4(2) = 20$ . So, we have verified that  $x = 4, y = 2$  is a solution of both the equations. **Since  $(4, 2)$  is the only common point on both the lines, there is one and only one solution for this pair of linear equations in two variables.**

Thus, the number of rides Akhila had on Giant Wheel is 4 and the number of times she played Hoopla is 2.

- In the situation of Example 2, can you find the cost of each pencil and each eraser?

In Fig. 3.3, the situation is geometrically shown by a pair of coincident lines. The solutions of the equations are given by the common points.

Are there any common points on these lines? From the graph, we observe that every point on the line is a common solution to both the equations. So, the equations  $2x + 3y = 9$  and  $4x + 6y = 18$  have **infinitely many solutions**. This should not surprise us, because if we divide the equation  $4x + 6y = 18$  by 2, we get  $2x + 3y = 9$ , which is the same as Equation (1). That is, both the equations are equivalent. From the graph, we see that any point on the line gives us a possible cost of each pencil and eraser. For instance, each pencil and eraser can cost ₹ 3 and ₹ 1 respectively. Or, each pencil can cost ₹ 3.75 and eraser can cost ₹ 0.50, and so on.

- In the situation of Example 3, can the two rails cross each other?

In Fig. 3.4, the situation is represented geometrically by two parallel lines. Since the lines do not intersect at all, the rails do not cross. This also means that the equations have no common solution.

A pair of linear equations which has no solution, is called an *inconsistent* pair of linear equations. A pair of linear equations in two variables, which has a solution, is called a *consistent* pair of linear equations. A pair of linear equations which are equivalent has infinitely many distinct common solutions. Such a pair is called a *dependent* pair of linear equations in two variables. Note that a dependent pair of linear equations is always consistent.

We can now summarise the behaviour of lines representing a pair of linear equations in two variables and the existence of solutions as follows:

- (i) the lines may intersect in a single point. In this case, the pair of equations has a unique solution (consistent pair of equations).
- (ii) the lines may be parallel. In this case, the equations have no solution (inconsistent pair of equations).
- (iii) the lines may be coincident. In this case, the equations have infinitely many solutions [dependent (consistent) pair of equations].

Let us now go back to the pairs of linear equations formed in Examples 1, 2, and 3, and note down what kind of pair they are geometrically.

- (i)  $x - 2y = 0$  and  $3x + 4y - 20 = 0$  (The lines intersect)
- (ii)  $2x + 3y - 9 = 0$  and  $4x + 6y - 18 = 0$  (The lines coincide)
- (iii)  $x + 2y - 4 = 0$  and  $2x + 4y - 12 = 0$  (The lines are parallel)

Let us now write down, and compare, the values of  $\frac{a_1}{a_2}$ ,  $\frac{b_1}{b_2}$  and  $\frac{c_1}{c_2}$  in all the three examples. Here,  $a_1$ ,  $b_1$ ,  $c_1$  and  $a_2$ ,  $b_2$ ,  $c_2$  denote the coefficients of equations given in the general form in Section 3.2.

**Table 3.4**

Sl No.	Pair of lines	$\frac{a_1}{a_2}$	$\frac{b_1}{b_2}$	$\frac{c_1}{c_2}$	Compare the ratios	Graphical representation	Algebraic interpretation
1.	$x - 2y = 0$ $3x + 4y - 20 = 0$	$\frac{1}{3}$	$\frac{-2}{4}$	$\frac{0}{-20}$	$\frac{a_1}{a_2} \neq \frac{b_1}{b_2}$	Intersecting lines	Exactly one solution (unique)
2.	$2x + 3y - 9 = 0$ $4x + 6y - 18 = 0$	$\frac{2}{4}$	$\frac{3}{6}$	$\frac{-9}{-18}$	$\frac{a_1}{a_2} = \frac{b_1}{b_2} = \frac{c_1}{c_2}$	Coincident lines	Infinitely many solutions
3.	$x + 2y - 4 = 0$ $2x + 4y - 12 = 0$	$\frac{1}{2}$	$\frac{2}{4}$	$\frac{-4}{-12}$	$\frac{a_1}{a_2} = \frac{b_1}{b_2} \neq \frac{c_1}{c_2}$	Parallel lines	No solution

From the table above, you can observe that if the lines represented by the equation

$$a_1x + b_1y + c_1 = 0$$

and

$$a_2x + b_2y + c_2 = 0$$

- are (i) intersecting, then  $\frac{a_1}{a_2} \neq \frac{b_1}{b_2}$ .
- (ii) coincident, then  $\frac{a_1}{a_2} = \frac{b_1}{b_2} = \frac{c_1}{c_2}$ .
- (iii) parallel, then  $\frac{a_1}{a_2} = \frac{b_1}{b_2} \neq \frac{c_1}{c_2}$ .

In fact, the converse is also true for any pair of lines. You can verify them by considering some more examples by yourself.

Let us now consider some more examples to illustrate it.

**Example 4 :** Check graphically whether the pair of equations

$$x + 3y = 6 \quad (1)$$

and  $2x - 3y = 12 \quad (2)$

is consistent. If so, solve them graphically.

**Solution :** Let us draw the graphs of the Equations (1) and (2). For this, we find two solutions of each of the equations, which are given in Table 3.5

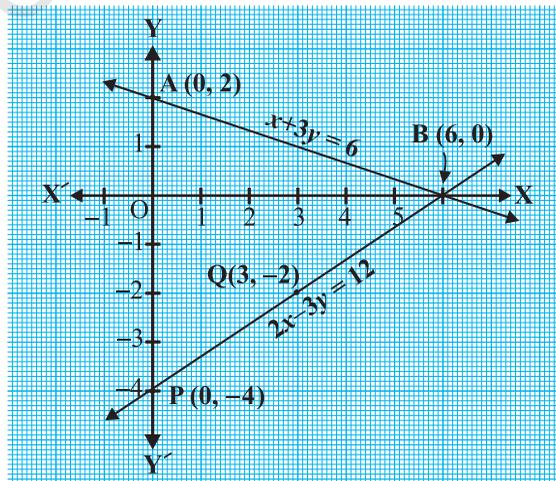
**Table 3.5**

$x$	0	6
$y = \frac{6-x}{3}$	2	0

$x$	0	3
$y = \frac{2x-12}{3}$	-4	-2

Plot the points A(0, 2), B(6, 0), P(0, -4) and Q(3, -2) on graph paper, and join the points to form the lines AB and PQ as shown in Fig. 3.5.

We observe that there is a point B(6, 0) common to both the lines AB and PQ. So, the solution of the pair of linear equations is  $x = 6$  and  $y = 0$ , i.e., the given pair of equations is consistent.



**Fig. 3.5**

**Example 5 :** Graphically, find whether the following pair of equations has no solution, unique solution or infinitely many solutions:

$$5x - 8y + 1 = 0 \quad (1)$$

$$3x - \frac{24}{5}y + \frac{3}{5} = 0 \quad (2)$$

**Solution :** Multiplying Equation (2) by  $\frac{5}{3}$ , we get

$$5x - 8y + 1 = 0$$

But, this is the same as Equation (1). Hence the lines represented by Equations (1) and (2) are coincident. Therefore, Equations (1) and (2) have infinitely many solutions.

Plot few points on the graph and verify it yourself.

**Example 6 :** Champa went to a ‘Sale’ to purchase some pants and skirts. When her friends asked her how many of each she had bought, she answered, “The number of skirts is two less than twice the number of pants purchased. Also, the number of skirts is four less than four times the number of pants purchased”. Help her friends to find how many pants and skirts Champa bought.

**Solution :** Let us denote the number of pants by  $x$  and the number of skirts by  $y$ . Then the equations formed are :

$$y = 2x - 2 \quad (1)$$

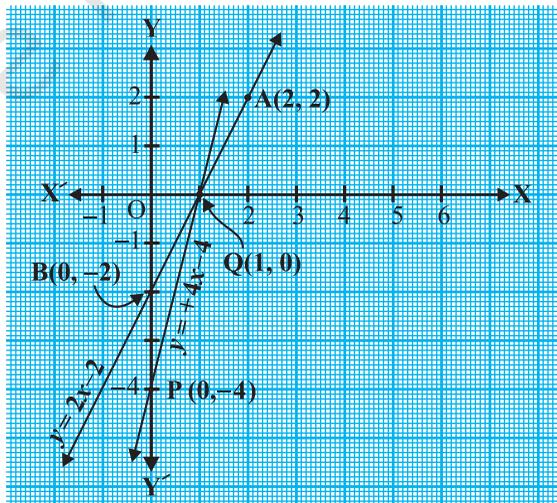
and

$$y = 4x - 4 \quad (2)$$

Let us draw the graphs of Equations (1) and (2) by finding two solutions for each of the equations. They are given in Table 3.6.

**Table 3.6**

$x$	2	0
$y = 2x - 2$	2	-2
$x$	0	1
$y = 4x - 4$	-4	0



**Fig. 3.6**

Plot the points and draw the lines passing through them to represent the equations, as shown in Fig. 3.6.

The two lines intersect at the point  $(1, 0)$ . So,  $x = 1, y = 0$  is the required solution of the pair of linear equations, i.e., the number of pants she purchased is 1 and she did not buy any skirt.

**Verify** the answer by checking whether it satisfies the conditions of the given problem.

### EXERCISE 3.2

- Form the pair of linear equations in the following problems, and find their solutions graphically.
  - 10 students of Class X took part in a Mathematics quiz. If the number of girls is 4 more than the number of boys, find the number of boys and girls who took part in the quiz.
  - 5 pencils and 7 pens together cost ₹ 50, whereas 7 pencils and 5 pens together cost ₹ 46. Find the cost of one pencil and that of one pen.
- On comparing the ratios  $\frac{a_1}{a_2}, \frac{b_1}{b_2}$  and  $\frac{c_1}{c_2}$ , find out whether the lines representing the following pairs of linear equations intersect at a point, are parallel or coincident:
  - $$\begin{aligned} 5x - 4y + 8 &= 0 & \text{(ii) } 9x + 3y + 12 &= 0 \\ 7x + 6y - 9 &= 0 & 18x + 6y + 24 &= 0 \end{aligned}$$
  - $$\begin{aligned} 6x - 3y + 10 &= 0 \\ 2x - y + 9 &= 0 \end{aligned}$$
- On comparing the ratios  $\frac{a_1}{a_2}, \frac{b_1}{b_2}$  and  $\frac{c_1}{c_2}$ , find out whether the following pair of linear equations are consistent, or inconsistent.
  - $$\begin{aligned} 3x + 2y &= 5; & 2x - 3y &= 7 & \text{(ii) } 2x - 3y &= 8; & 4x - 6y &= 9 \end{aligned}$$
  - $$\begin{aligned} \frac{3}{2}x + \frac{5}{3}y &= 7; & 9x - 10y &= 14 & \text{(iv) } 5x - 3y &= 11; & -10x + 6y &= -22 \end{aligned}$$
  - $$\frac{4}{3}x + 2y = 8; & 2x + 3y = 12$$
- Which of the following pairs of linear equations are consistent/inconsistent? If consistent, obtain the solution graphically:

- (i)  $x + y = 5$ ,  $2x + 2y = 10$   
 (ii)  $x - y = 8$ ,  $3x - 3y = 16$   
 (iii)  $2x + y - 6 = 0$ ,  $4x - 2y - 4 = 0$   
 (iv)  $2x - 2y - 2 = 0$ ,  $4x - 4y - 5 = 0$
5. Half the perimeter of a rectangular garden, whose length is 4 m more than its width, is 36 m. Find the dimensions of the garden.
6. Given the linear equation  $2x + 3y - 8 = 0$ , write another linear equation in two variables such that the geometrical representation of the pair so formed is:  
 (i) intersecting lines                      (ii) parallel lines  
 (iii) coincident lines
7. Draw the graphs of the equations  $x - y + 1 = 0$  and  $3x + 2y - 12 = 0$ . Determine the coordinates of the vertices of the triangle formed by these lines and the  $x$ -axis, and shade the triangular region.

### 3.4 Algebraic Methods of Solving a Pair of Linear Equations

In the previous section, we discussed how to solve a pair of linear equations graphically. The graphical method is not convenient in cases when the point representing the solution of the linear equations has non-integral coordinates like  $(\sqrt{3}, 2\sqrt{7})$ ,  $(-1.75, 3.3)$ ,  $(\frac{4}{13}, \frac{1}{19})$ , etc. There is every possibility of making mistakes while reading such coordinates. Is there any alternative method of finding the solution? There are several algebraic methods, which we shall now discuss.

**3.4.1 Substitution Method :** We shall explain the method of substitution by taking some examples.

**Example 7 :** Solve the following pair of equations by substitution method:

$$7x - 15y = 2 \quad (1)$$

$$x + 2y = 3 \quad (2)$$

**Solution :**

**Step 1 :** We pick either of the equations and write one variable in terms of the other. Let us consider the Equation (2) :

$$x + 2y = 3$$

and write it as

$$x = 3 - 2y \quad (3)$$

**Step 2 :** Substitute the value of  $x$  in Equation (1). We get

$$7(3 - 2y) - 15y = 2$$

i.e.,  $21 - 14y - 15y = 2$

i.e.,  $-29y = -19$

Therefore,  $y = \frac{19}{29}$

**Step 3 :** Substituting this value of  $y$  in Equation (3), we get

$$x = 3 - 2\left(\frac{19}{29}\right) = \frac{49}{29}$$

Therefore, the solution is  $x = \frac{49}{29}$ ,  $y = \frac{19}{29}$ .

**Verification :** Substituting  $x = \frac{49}{29}$  and  $y = \frac{19}{29}$ , you can verify that both the Equations (1) and (2) are satisfied.

To understand the substitution method more clearly, let us consider it stepwise:

**Step 1 :** Find the value of one variable, say  $y$  in terms of the other variable, i.e.,  $x$  from either equation, whichever is convenient.

**Step 2 :** Substitute this value of  $y$  in the other equation, and reduce it to an equation in one variable, i.e., in terms of  $x$ , which can be solved. Sometimes, as in Examples 9 and 10 below, you can get statements with no variable. If this statement is true, you can conclude that the pair of linear equations has infinitely many solutions. If the statement is false, then the pair of linear equations is inconsistent.

**Step 3 :** Substitute the value of  $x$  (or  $y$ ) obtained in Step 2 in the equation used in Step 1 to obtain the value of the other variable.

**Remark :** We have **substituted** the value of one variable by expressing it in terms of the other variable to solve the pair of linear equations. That is why the method is known as the *substitution method*.

**Example 8 :** Solve Q.1 of Exercise 3.1 by the method of substitution.

**Solution :** Let  $s$  and  $t$  be the ages (in years) of Aftab and his daughter, respectively. Then, the pair of linear equations that represent the situation is

$$s - 7 = 7(t - 7), \text{ i.e., } s - 7t + 42 = 0 \quad (1)$$

and  $s + 3 = 3(t + 3), \text{ i.e., } s - 3t = 6 \quad (2)$

Using Equation (2), we get  $s = 3t + 6$ .

Putting this value of  $s$  in Equation (1), we get

$$(3t + 6) - 7t + 42 = 0,$$

i.e.,  $4t = 48$ , which gives  $t = 12$ .

Putting this value of  $t$  in Equation (2), we get

$$s = 3(12) + 6 = 42$$

So, Aftab and his daughter are 42 and 12 years old, respectively.

Verify this answer by checking if it satisfies the conditions of the given problems.

**Example 9 :** Let us consider Example 2 in Section 3.3, i.e., the cost of 2 pencils and 3 erasers is ₹ 9 and the cost of 4 pencils and 6 erasers is ₹ 18. Find the cost of each pencil and each eraser.

**Solution :** The pair of linear equations formed were:

$$2x + 3y = 9 \quad (1)$$

$$4x + 6y = 18 \quad (2)$$

We first express the value of  $x$  in terms of  $y$  from the equation  $2x + 3y = 9$ , to get

$$x = \frac{9 - 3y}{2} \quad (3)$$

Now we substitute this value of  $x$  in Equation (2), to get

$$\frac{4(9 - 3y)}{2} + 6y = 18$$

i.e.,  $18 - 6y + 6y = 18$

i.e.,  $18 = 18$

This statement is true for all values of  $y$ . However, we do not get a specific value of  $y$  as a solution. Therefore, we cannot obtain a specific value of  $x$ . This situation has arisen because both the given equations are the same. Therefore, Equations (1) and (2) have *infinitely many solutions*. Observe that we have obtained the same solution graphically also. (Refer to Fig. 3.3, Section 3.2.) We cannot find a unique cost of a pencil and an eraser, because there are many common solutions, to the given situation.

**Example 10 :** Let us consider the Example 3 of Section 3.2. Will the rails cross each other?

**Solution :** The pair of linear equations formed were:

$$x + 2y - 4 = 0 \quad (1)$$

$$2x + 4y - 12 = 0 \quad (2)$$

We express  $x$  in terms of  $y$  from Equation (1) to get

$$x = 4 - 2y$$

Now, we substitute this value of  $x$  in Equation (2) to get

$$2(4 - 2y) + 4y - 12 = 0$$

$$\text{i.e.,} \quad 8 - 12 = 0$$

$$\text{i.e.,} \quad -4 = 0$$

which is a false statement.

Therefore, the equations do not have a common solution. So, the two rails will not cross each other.

### EXERCISE 3.3

1. Solve the following pair of linear equations by the substitution method.

(i)  $x + y = 14$

(ii)  $s - t = 3$

$$x - y = 4$$

$$\frac{s}{3} + \frac{t}{2} = 6$$

(iii)  $3x - y = 3$

(iv)  $0.2x + 0.3y = 1.3$

$$9x - 3y = 9$$

$$0.4x + 0.5y = 2.3$$

(v)  $\sqrt{2}x + \sqrt{3}y = 0$

(vi)  $\frac{3x}{2} - \frac{5y}{3} = -2$

$$\sqrt{3}x - \sqrt{8}y = 0$$

$$\frac{x}{3} + \frac{y}{2} = \frac{13}{6}$$

2. Solve  $2x + 3y = 11$  and  $2x - 4y = -24$  and hence find the value of ' $m$ ' for which  $y = mx + 3$ .

3. Form the pair of linear equations for the following problems and find their solution by substitution method.

(i) The difference between two numbers is 26 and one number is three times the other. Find them.

(ii) The larger of two supplementary angles exceeds the smaller by 18 degrees. Find them.

(iii) The coach of a cricket team buys 7 bats and 6 balls for ₹ 3800. Later, she buys 3 bats and 5 balls for ₹ 1750. Find the cost of each bat and each ball.

- (iv) The taxi charges in a city consist of a fixed charge together with the charge for the distance covered. For a distance of 10 km, the charge paid is ₹ 105 and for a journey of 15 km, the charge paid is ₹ 155. What are the fixed charges and the charge per km? How much does a person have to pay for travelling a distance of 25 km?
- (v) A fraction becomes  $\frac{9}{11}$ , if 2 is added to both the numerator and the denominator. If, 3 is added to both the numerator and the denominator it becomes  $\frac{5}{6}$ . Find the fraction.
- (vi) Five years hence, the age of Jacob will be three times that of his son. Five years ago, Jacob's age was seven times that of his son. What are their present ages?

### 3.4.2 Elimination Method

Now let us consider another method of eliminating (i.e., removing) one variable. This is sometimes more convenient than the substitution method. Let us see how this method works.

**Example 11 :** The ratio of incomes of two persons is 9 : 7 and the ratio of their expenditures is 4 : 3. If each of them manages to save ₹ 2000 per month, find their monthly incomes.

**Solution :** Let us denote the incomes of the two person by ₹  $9x$  and ₹  $7x$  and their expenditures by ₹  $4y$  and ₹  $3y$  respectively. Then the equations formed in the situation is given by :

$$9x - 4y = 2000 \quad (1)$$

and 
$$7x - 3y = 2000 \quad (2)$$

**Step 1 :** Multiply Equation (1) by 3 and Equation (2) by 4 to make the coefficients of  $y$  equal. Then we get the equations:

$$27x - 12y = 6000 \quad (3)$$

$$28x - 12y = 8000 \quad (4)$$

**Step 2 :** Subtract Equation (3) from Equation (4) to *eliminate*  $y$ , because the coefficients of  $y$  are the same. So, we get

$$(28x - 27x) - (12y - 12y) = 8000 - 6000$$

i.e., 
$$x = 2000$$

**Step 3 :** Substituting this value of  $x$  in (1), we get

$$9(2000) - 4y = 2000$$

i.e., 
$$y = 4000$$

So, the solution of the equations is  $x = 2000$ ,  $y = 4000$ . Therefore, the monthly incomes of the persons are ₹ 18,000 and ₹ 14,000, respectively.

**Verification :**  $18000 : 14000 = 9 : 7$ . Also, the ratio of their expenditures =  $18000 - 2000 : 14000 - 2000 = 16000 : 12000 = 4 : 3$

**Remarks :**

1. The method used in solving the example above is called the *elimination* method, because we eliminate one variable first, to get a linear equation in one variable. In the example above, we eliminated  $y$ . We could also have eliminated  $x$ . Try doing it that way.
2. You could also have used the substitution, or graphical method, to solve this problem. Try doing so, and see which method is more convenient.

Let us now note down these steps in the elimination method :

**Step 1 :** First multiply both the equations by some suitable non-zero constants to make the coefficients of one variable (either  $x$  or  $y$ ) numerically equal.

**Step 2 :** Then add or subtract one equation from the other so that one variable gets eliminated. If you get an equation in one variable, go to Step 3.

If in Step 2, we obtain a true statement involving no variable, then the original pair of equations has infinitely many solutions.

If in Step 2, we obtain a false statement involving no variable, then the original pair of equations has no solution, i.e., it is inconsistent.

**Step 3 :** Solve the equation in one variable ( $x$  or  $y$ ) so obtained to get its value.

**Step 4 :** Substitute this value of  $x$  (or  $y$ ) in either of the original equations to get the value of the other variable.

Now to illustrate it, we shall solve few more examples.

**Example 12 :** Use elimination method to find all possible solutions of the following pair of linear equations :

$$2x + 3y = 8 \quad (1)$$

$$4x + 6y = 7 \quad (2)$$

**Solution :**

**Step 1 :** Multiply Equation (1) by 2 and Equation (2) by 1 to make the coefficients of  $x$  equal. Then we get the equations as :

$$4x + 6y = 16 \quad (3)$$

$$4x + 6y = 7 \quad (4)$$

**Step 2 :** Subtracting Equation (4) from Equation (3),

$$(4x - 4x) + (6y - 6y) = 16 - 7$$

i.e.,  $0 = 9$ , which is a false statement.

Therefore, the pair of equations has no solution.

**Example 13 :** The sum of a two-digit number and the number obtained by reversing the digits is 66. If the digits of the number differ by 2, find the number. How many such numbers are there?

**Solution :** Let the ten's and the unit's digits in the first number be  $x$  and  $y$ , respectively. So, the first number may be written as  $10x + y$  in the expanded form (for example,  $56 = 10(5) + 6$ ).

When the digits are reversed,  $x$  becomes the unit's digit and  $y$  becomes the ten's digit. This number, in the expanded notation is  $10y + x$  (for example, when 56 is reversed, we get  $65 = 10(6) + 5$ ).

According to the given condition.

$$(10x + y) + (10y + x) = 66$$

i.e.,  $11(x + y) = 66$

i.e.,  $x + y = 6$  (1)

We are also given that the digits differ by 2, therefore,

either  $x - y = 2$  (2)

or  $y - x = 2$  (3)

If  $x - y = 2$ , then solving (1) and (2) by elimination, we get  $x = 4$  and  $y = 2$ .

In this case, we get the number 42.

If  $y - x = 2$ , then solving (1) and (3) by elimination, we get  $x = 2$  and  $y = 4$ .

In this case, we get the number 24.

Thus, there are two such numbers 42 and 24.

**Verification :** Here  $42 + 24 = 66$  and  $4 - 2 = 2$ . Also  $24 + 42 = 66$  and  $4 - 2 = 2$ .

### EXERCISE 3.4

1. Solve the following pair of linear equations by the elimination method and the substitution method :

(i)  $x + y = 5$  and  $2x - 3y = 4$

(ii)  $3x + 4y = 10$  and  $2x - 2y = 2$

(iii)  $3x - 5y - 4 = 0$  and  $9x = 2y + 7$

(iv)  $\frac{x}{2} + \frac{2y}{3} = -1$  and  $x - \frac{y}{3} = 3$

2. Form the pair of linear equations in the following problems, and find their solutions (if they exist) by the elimination method :
- If we add 1 to the numerator and subtract 1 from the denominator, a fraction reduces to 1. It becomes  $\frac{1}{2}$  if we only add 1 to the denominator. What is the fraction?
  - Five years ago, Nuri was thrice as old as Sonu. Ten years later, Nuri will be twice as old as Sonu. How old are Nuri and Sonu?
  - The sum of the digits of a two-digit number is 9. Also, nine times this number is twice the number obtained by reversing the order of the digits. Find the number.
  - Meena went to a bank to withdraw ₹ 2000. She asked the cashier to give her ₹ 50 and ₹ 100 notes only. Meena got 25 notes in all. Find how many notes of ₹ 50 and ₹ 100 she received.
  - A lending library has a fixed charge for the first three days and an additional charge for each day thereafter. Saritha paid ₹ 27 for a book kept for seven days, while Susy paid ₹ 21 for the book she kept for five days. Find the fixed charge and the charge for each extra day.

### 3.4.3 Cross - Multiplication Method

So far, you have learnt how to solve a pair of linear equations in two variables by graphical, substitution and elimination methods. Here, we introduce one more algebraic method to solve a pair of linear equations which for many reasons is a very useful method of solving these equations. Before we proceed further, let us consider the following situation.

The cost of 5 oranges and 3 apples is ₹ 35 and the cost of 2 oranges and 4 apples is ₹ 28. Let us find the cost of an orange and an apple.

Let us denote the cost of an orange by ₹  $x$  and the cost of an apple by ₹  $y$ . Then, the equations formed are :

$$5x + 3y = 35, \text{ i.e., } 5x + 3y - 35 = 0 \quad (1)$$

$$2x + 4y = 28, \text{ i.e., } 2x + 4y - 28 = 0 \quad (2)$$

Let us use the elimination method to solve these equations.

Multiply Equation (1) by 4 and Equation (2) by 3. We get

$$(4)(5)x + (4)(3)y + (4)(-35) = 0 \quad (3)$$

$$(3)(2)x + (3)(4)y + (3)(-28) = 0 \quad (4)$$

Subtracting Equation (4) from Equation (3), we get

$$[(5)(4) - (3)(2)]x + [(4)(3) - (3)(4)]y + [4(-35) - (3)(-28)] = 0$$

Therefore,

$$x = \frac{-[(4)(-35) - (3)(-28)]}{(5)(4) - (3)(2)}$$

i.e.,

$$x = \frac{(3)(-28) - (4)(-35)}{(5)(4) - (2)(3)} \quad (5)$$

If Equations (1) and (2) are written as  $a_1x + b_1y + c_1 = 0$  and  $a_2x + b_2y + c_2 = 0$ , then we have

$$a_1 = 5, b_1 = 3, c_1 = -35, a_2 = 2, b_2 = 4, c_2 = -28.$$

Then Equation (5) can be written as  $x = \frac{b_1c_2 - b_2c_1}{a_1b_2 - a_2b_1}$ ,

Similarly, you can get

$$y = \frac{c_1a_2 - c_2a_1}{a_1b_2 - a_2b_1}$$

By simplifying Equation (5), we get

$$x = \frac{-84 + 140}{20 - 6} = 4$$

Similarly,

$$y = \frac{(-35)(2) - (5)(-28)}{20 - 6} = \frac{-70 + 140}{14} = 5$$

Therefore,  $x = 4, y = 5$  is the solution of the given pair of equations.

Then, the cost of an orange is ₹ 4 and that of an apple is ₹ 5.

**Verification :** Cost of 5 oranges + Cost of 3 apples = ₹ 20 + ₹ 15 = ₹ 35. Cost of 2 oranges + Cost of 4 apples = ₹ 8 + ₹ 20 = ₹ 28.

Let us now see how this method works for any pair of linear equations in two variables of the form

$$a_1x + b_1y + c_1 = 0 \quad (1)$$

and

$$a_2x + b_2y + c_2 = 0 \quad (2)$$

To obtain the values of  $x$  and  $y$  as shown above, we follow the following steps:

**Step 1 :** Multiply Equation (1) by  $b_2$  and Equation (2) by  $b_1$ , to get

$$b_2a_1x + b_2b_1y + b_2c_1 = 0 \quad (3)$$

$$b_1a_2x + b_1b_2y + b_1c_2 = 0 \quad (4)$$

**Step 2 :** Subtracting Equation (4) from (3), we get:

$$(b_2a_1 - b_1a_2)x + (b_2b_1 - b_1b_2)y + (b_2c_1 - b_1c_2) = 0$$

i.e., 
$$(b_2a_1 - b_1a_2)x = b_1c_2 - b_2c_1$$

So, 
$$x = \frac{b_1c_2 - b_2c_1}{a_1b_2 - a_2b_1}, \text{ provided } a_1b_2 - a_2b_1 \neq 0 \quad (5)$$

**Step 3 :** Substituting this value of  $x$  in (1) or (2), we get

$$y = \frac{c_1a_2 - c_2a_1}{a_1b_2 - a_2b_1} \quad (6)$$

Now, two cases arise :

**Case 1 :**  $a_1b_2 - a_2b_1 \neq 0$ . In this case  $\frac{a_1}{a_2} \neq \frac{b_1}{b_2}$ . Then the pair of linear equations has a unique solution.

**Case 2 :**  $a_1b_2 - a_2b_1 = 0$ . If we write  $\frac{a_1}{a_2} = \frac{b_1}{b_2} = k$ , then  $a_1 = k a_2$ ,  $b_1 = k b_2$ .

Substituting the values of  $a_1$  and  $b_1$  in the Equation (1), we get

$$k(a_2x + b_2y) + c_1 = 0. \quad (7)$$

It can be observed that the Equations (7) and (2) can both be satisfied only if

$$c_1 = k c_2, \text{ i.e., } \frac{c_1}{c_2} = k.$$

If  $c_1 = k c_2$ , any solution of Equation (2) will satisfy the Equation (1), and vice versa. So, if  $\frac{a_1}{a_2} = \frac{b_1}{b_2} = \frac{c_1}{c_2} = k$ , then there are infinitely many solutions to the pair of linear equations given by (1) and (2).

If  $c_1 \neq k c_2$ , then any solution of Equation (1) will not satisfy Equation (2) and vice versa. Therefore the pair has no solution.

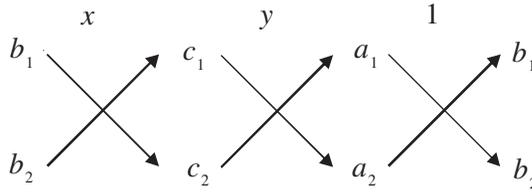
We can summarise the discussion above for the pair of linear equations given by (1) and (2) as follows:

- (i) When  $\frac{a_1}{a_2} \neq \frac{b_1}{b_2}$ , we get a unique solution.
- (ii) When  $\frac{a_1}{a_2} = \frac{b_1}{b_2} = \frac{c_1}{c_2}$ , there are infinitely many solutions.
- (iii) When  $\frac{a_1}{a_2} = \frac{b_1}{b_2} \neq \frac{c_1}{c_2}$ , there is no solution.

Note that you can write the solution given by Equations (5) and (6) in the following form :

$$\frac{x}{b_1c_2 - b_2c_1} = \frac{y}{c_1a_2 - c_2a_1} = \frac{1}{a_1b_2 - a_2b_1} \quad (8)$$

In remembering the above result, the following diagram may be helpful to you :



The arrows between the two numbers indicate that they are to be multiplied and the second product is to be subtracted from the first.

For solving a pair of linear equations by this method, we will follow the following steps :

**Step 1 :** Write the given equations in the form (1) and (2).

**Step 2 :** Taking the help of the diagram above, write Equations as given in (8).

**Step 3 :** Find  $x$  and  $y$ , provided  $a_1b_2 - a_2b_1 \neq 0$

Step 2 above gives you an indication of why this method is called the **cross-multiplication method**.

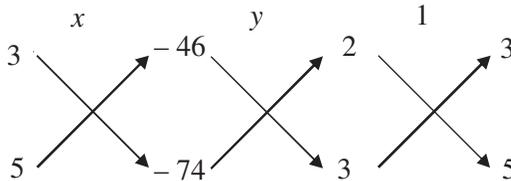
**Example 14 :** From a bus stand in Bangalore , if we buy 2 tickets to Malleswaram and 3 tickets to Yeshwanthpur, the total cost is ₹ 46; but if we buy 3 tickets to Malleswaram and 5 tickets to Yeshwanthpur the total cost is ₹ 74. Find the fares from the bus stand to Malleswaram, and to Yeshwanthpur.

**Solution :** Let ₹  $x$  be the fare from the bus stand in Bangalore to Malleswaram, and ₹  $y$  to Yeshwanthpur. From the given information, we have

$$2x + 3y = 46, \text{ i.e., } 2x + 3y - 46 = 0 \quad (1)$$

$$3x + 5y = 74, \text{ i.e., } 3x + 5y - 74 = 0 \quad (2)$$

To solve the equations by the cross-multiplication method, we draw the diagram as given below.



Then 
$$\frac{x}{(3)(-74) - (5)(-46)} = \frac{y}{(-46)(3) - (-74)(2)} = \frac{1}{(2)(5) - (3)(3)}$$

i.e., 
$$\frac{x}{-222 + 230} = \frac{y}{-138 + 148} = \frac{1}{10 - 9}$$

i.e., 
$$\frac{x}{8} = \frac{y}{10} = \frac{1}{1}$$

i.e., 
$$\frac{x}{8} = \frac{1}{1} \text{ and } \frac{y}{10} = \frac{1}{1}$$

i.e., 
$$x = 8 \text{ and } y = 10$$

Hence, the fare from the bus stand in Bangalore to Malleswaram is ₹ 8 and the fare to Yeshwanthpur is ₹ 10.

**Verification :** You can check from the problem that the solution we have got is correct.

**Example 15 :** For which values of  $p$  does the pair of equations given below has unique solution?

$$4x + py + 8 = 0$$

$$2x + 2y + 2 = 0$$

**Solution :** Here  $a_1 = 4, a_2 = 2, b_1 = p, b_2 = 2$ .

Now for the given pair to have a unique solution :  $\frac{a_1}{a_2} \neq \frac{b_1}{b_2}$

i.e., 
$$\frac{4}{2} \neq \frac{p}{2}$$

i.e., 
$$p \neq 4$$

Therefore, for all values of  $p$ , except 4, the given pair of equations will have a unique solution.

**Example 16 :** For what values of  $k$  will the following pair of linear equations have infinitely many solutions?

$$kx + 3y - (k - 3) = 0$$

$$12x + ky - k = 0$$

**Solution :** Here,  $\frac{a_1}{a_2} = \frac{k}{12}, \frac{b_1}{b_2} = \frac{3}{k}, \frac{c_1}{c_2} = \frac{k-3}{k}$

For a pair of linear equations to have infinitely many solutions :  $\frac{a_1}{a_2} = \frac{b_1}{b_2} = \frac{c_1}{c_2}$

So, we need 
$$\frac{k}{12} = \frac{3}{k} = \frac{k-3}{k}$$

or, 
$$\frac{k}{12} = \frac{3}{k}$$

which gives  $k^2 = 36$ , i.e.,  $k = \pm 6$ .

Also, 
$$\frac{3}{k} = \frac{k-3}{k}$$

gives  $3k = k^2 - 3k$ , i.e.,  $6k = k^2$ , which means  $k = 0$  or  $k = 6$ .

Therefore, the value of  $k$ , that satisfies both the conditions, is  $k = 6$ . For this value, the pair of linear equations has infinitely many solutions.

### EXERCISE 3.5

1. Which of the following pairs of linear equations has unique solution, no solution, or infinitely many solutions. In case there is a unique solution, find it by using cross multiplication method.

(i)  $x - 3y - 3 = 0$

$3x - 9y - 2 = 0$

(iii)  $3x - 5y = 20$

$6x - 10y = 40$

(ii)  $2x + y = 5$

$3x + 2y = 8$

(iv)  $x - 3y - 7 = 0$

$3x - 3y - 15 = 0$

2. (i) For which values of  $a$  and  $b$  does the following pair of linear equations have an infinite number of solutions?

$2x + 3y = 7$

$(a - b)x + (a + b)y = 3a + b - 2$

- (ii) For which value of  $k$  will the following pair of linear equations have no solution?

$3x + y = 1$

$(2k - 1)x + (k - 1)y = 2k + 1$

3. Solve the following pair of linear equations by the substitution and cross-multiplication methods :

$8x + 5y = 9$

$3x + 2y = 4$

4. Form the pair of linear equations in the following problems and find their solutions (if they exist) by any algebraic method :

- (i) A part of monthly hostel charges is fixed and the remaining depends on the number of days one has taken food in the mess. When a student A takes food for 20 days she has to pay ₹ 1000 as hostel charges whereas a student B, who takes food for 26 days, pays ₹ 1180 as hostel charges. Find the fixed charges and the cost of food per day.
- (ii) A fraction becomes  $\frac{1}{3}$  when 1 is subtracted from the numerator and it becomes  $\frac{1}{4}$  when 8 is added to its denominator. Find the fraction.
- (iii) Yash scored 40 marks in a test, getting 3 marks for each right answer and losing 1 mark for each wrong answer. Had 4 marks been awarded for each correct answer and 2 marks been deducted for each incorrect answer, then Yash would have scored 50 marks. How many questions were there in the test?
- (iv) Places A and B are 100 km apart on a highway. One car starts from A and another from B at the same time. If the cars travel in the same direction at different speeds, they meet in 5 hours. If they travel towards each other, they meet in 1 hour. What are the speeds of the two cars?
- (v) The area of a rectangle gets reduced by 9 square units, if its length is reduced by 5 units and breadth is increased by 3 units. If we increase the length by 3 units and the breadth by 2 units, the area increases by 67 square units. Find the dimensions of the rectangle.

### 3.5 Equations Reducible to a Pair of Linear Equations in Two Variables

In this section, we shall discuss the solution of such pairs of equations which are not linear but can be reduced to linear form by making some suitable substitutions. We now explain this process through some examples.

**Example 17 :** Solve the pair of equations:

$$\frac{2}{x} + \frac{3}{y} = 13$$

$$\frac{5}{x} - \frac{4}{y} = -2$$

**Solution :** Let us write the given pair of equations as

$$2\left(\frac{1}{x}\right) + 3\left(\frac{1}{y}\right) = 13 \quad (1)$$

$$5\left(\frac{1}{x}\right) - 4\left(\frac{1}{y}\right) = -2 \quad (2)$$

These equations are not in the form  $ax + by + c = 0$ . However, if we substitute

$\frac{1}{x} = p$  and  $\frac{1}{y} = q$  in Equations (1) and (2), we get

$$2p + 3q = 13 \quad (3)$$

$$5p - 4q = -2 \quad (4)$$

So, we have expressed the equations as a pair of linear equations. Now, you can use any method to solve these equations, and get  $p = 2$ ,  $q = 3$ .

You know that  $p = \frac{1}{x}$  and  $q = \frac{1}{y}$ .

Substitute the values of  $p$  and  $q$  to get

$$\frac{1}{x} = 2, \text{ i.e., } x = \frac{1}{2} \text{ and } \frac{1}{y} = 3, \text{ i.e., } y = \frac{1}{3}.$$

**Verification :** By substituting  $x = \frac{1}{2}$  and  $y = \frac{1}{3}$  in the given equations, we find that both the equations are satisfied.

**Example 18 :** Solve the following pair of equations by reducing them to a pair of linear equations :

$$\frac{5}{x-1} + \frac{1}{y-2} = 2$$

$$\frac{6}{x-1} - \frac{3}{y-2} = 1$$

**Solution :** Let us put  $\frac{1}{x-1} = p$  and  $\frac{1}{y-2} = q$ . Then the given equations

$$5\left(\frac{1}{x-1}\right) + \frac{1}{y-2} = 2 \quad (1)$$

$$6\left(\frac{1}{x-1}\right) - 3\left(\frac{1}{y-2}\right) = 1 \quad (2)$$

can be written as :  $5p + q = 2 \quad (3)$

$$6p - 3q = 1 \quad (4)$$

Equations (3) and (4) form a pair of linear equations in the general form. Now, you can use any method to solve these equations. We get  $p = \frac{1}{3}$  and  $q = \frac{1}{3}$ .

Now, substituting  $\frac{1}{x-1}$  for  $p$ , we have

$$\frac{1}{x-1} = \frac{1}{3},$$

i.e.,  $x - 1 = 3$ , i.e.,  $x = 4$ .

Similarly, substituting  $\frac{1}{y-2}$  for  $q$ , we get

$$\frac{1}{y-2} = \frac{1}{3}$$

i.e.,  $3 = y - 2$ , i.e.,  $y = 5$

Hence,  $x = 4$ ,  $y = 5$  is the required solution of the given pair of equations.

**Verification :** Substitute  $x = 4$  and  $y = 5$  in (1) and (2) to check whether they are satisfied.

**Example 19 :** A boat goes 30 km upstream and 44 km downstream in 10 hours. In 13 hours, it can go 40 km upstream and 55 km down-stream. Determine the speed of the stream and that of the boat in still water.

**Solution :** Let the speed of the boat in still water be  $x$  km/h and speed of the stream be  $y$  km/h. Then the speed of the boat downstream =  $(x + y)$  km/h,

and the speed of the boat upstream =  $(x - y)$  km/h

Also, 
$$\text{time} = \frac{\text{distance}}{\text{speed}}$$

In the first case, when the boat goes 30 km upstream, let the time taken, in hour, be  $t_1$ . Then

$$t_1 = \frac{30}{x - y}$$



Let  $t_2$  be the time, in hours, taken by the boat to go 44 km downstream. Then  $t_2 = \frac{44}{x+y}$ . The total time taken,  $t_1 + t_2$ , is 10 hours. Therefore, we get the equation

$$\frac{30}{x-y} + \frac{44}{x+y} = 10 \quad (1)$$

In the second case, in 13 hours it can go 40 km upstream and 55 km downstream. We get the equation

$$\frac{40}{x-y} + \frac{55}{x+y} = 13 \quad (2)$$

Put  $\frac{1}{x-y} = u$  and  $\frac{1}{x+y} = v$  (3)

On substituting these values in Equations (1) and (2), we get the pair of linear equations:

$$30u + 44v = 10 \quad \text{or} \quad 30u + 44v - 10 = 0 \quad (4)$$

$$40u + 55v = 13 \quad \text{or} \quad 40u + 55v - 13 = 0 \quad (5)$$

Using Cross-multiplication method, we get

$$\frac{u}{44(-13) - 55(-10)} = \frac{v}{40(-10) - 30(-13)} = \frac{1}{30(55) - 44(40)}$$

i.e.,  $\frac{u}{-22} = \frac{v}{-10} = \frac{1}{-110}$

i.e.,  $u = \frac{1}{5}, v = \frac{1}{11}$

Now put these values of  $u$  and  $v$  in Equations (3), we get

$$\frac{1}{x-y} = \frac{1}{5} \quad \text{and} \quad \frac{1}{x+y} = \frac{1}{11}$$

i.e.,  $x - y = 5$  and  $x + y = 11$  (6)

Adding these equations, we get

$$2x = 16$$

i.e.,  $x = 8$

Subtracting the equations in (6), we get

$$2y = 6$$

i.e.,  $y = 3$

Hence, the speed of the boat in still water is 8 km/h and the speed of the stream is 3 km/h.

**Verification :** Verify that the solution satisfies the conditions of the problem.

### EXERCISE 3.6

1. Solve the following pairs of equations by reducing them to a pair of linear equations:

$$(i) \frac{1}{2x} + \frac{1}{3y} = 2$$

$$(ii) \frac{2}{\sqrt{x}} + \frac{3}{\sqrt{y}} = 2$$

$$\frac{1}{3x} + \frac{1}{2y} = \frac{13}{6}$$

$$\frac{4}{\sqrt{x}} - \frac{9}{\sqrt{y}} = -1$$

$$(iii) \frac{4}{x} + 3y = 14$$

$$(iv) \frac{5}{x-1} + \frac{1}{y-2} = 2$$

$$\frac{3}{x} - 4y = 23$$

$$\frac{6}{x-1} - \frac{3}{y-2} = 1$$

$$(v) \frac{7x-2y}{xy} = 5$$

$$(vi) 6x+3y=6xy$$

$$\frac{8x+7y}{xy} = 15$$

$$2x+4y=5xy$$

$$(vii) \frac{10}{x+y} + \frac{2}{x-y} = 4$$

$$(viii) \frac{1}{3x+y} + \frac{1}{3x-y} = \frac{3}{4}$$

$$\frac{15}{x+y} - \frac{5}{x-y} = -2$$

$$\frac{1}{2(3x+y)} - \frac{1}{2(3x-y)} = \frac{-1}{8}$$

2. Formulate the following problems as a pair of equations, and hence find their solutions:

(i) Ritu can row downstream 20 km in 2 hours, and upstream 4 km in 2 hours. Find her speed of rowing in still water and the speed of the current.

(ii) 2 women and 5 men can together finish an embroidery work in 4 days, while 3 women and 6 men can finish it in 3 days. Find the time taken by 1 woman alone to finish the work, and also that taken by 1 man alone.

(iii) Roohi travels 300 km to her home partly by train and partly by bus. She takes 4 hours if she travels 60 km by train and the remaining by bus. If she travels 100 km by train and the remaining by bus, she takes 10 minutes longer. Find the speed of the train and the bus separately.

### EXERCISE 3.7 (Optional)\*

- The ages of two friends Ani and Biju differ by 3 years. Ani's father Dharam is twice as old as Ani and Biju is twice as old as his sister Cathy. The ages of Cathy and Dharam differ by 30 years. Find the ages of Ani and Biju.
- One says, "Give me a hundred, friend! I shall then become twice as rich as you". The other replies, "If you give me ten, I shall be six times as rich as you". Tell me what is the amount of their (respective) capital? [From the Bijaganita of Bhaskara II]  
[Hint :  $x + 100 = 2(y - 100)$ ,  $y + 10 = 6(x - 10)$ ].
- A train covered a certain distance at a uniform speed. If the train would have been 10 km/h faster, it would have taken 2 hours less than the scheduled time. And, if the train were slower by 10 km/h; it would have taken 3 hours more than the scheduled time. Find the distance covered by the train.
- The students of a class are made to stand in rows. If 3 students are extra in a row, there would be 1 row less. If 3 students are less in a row, there would be 2 rows more. Find the number of students in the class.
- In a  $\triangle ABC$ ,  $\angle C = 3 \angle B = 2(\angle A + \angle B)$ . Find the three angles.
- Draw the graphs of the equations  $5x - y = 5$  and  $3x - y = 3$ . Determine the co-ordinates of the vertices of the triangle formed by these lines and the  $y$  axis.
- Solve the following pair of linear equations:
  - $px + qy = p - q$   
 $qx - py = p + q$
  - $ax + by = c$   
 $bx + ay = 1 + c$
  - $\frac{x}{a} - \frac{y}{b} = 0$   
 $ax + by = a^2 + b^2$
  - $(a - b)x + (a + b)y = a^2 - 2ab - b^2$   
 $(a + b)(x + y) = a^2 + b^2$
  - $152x - 378y = -74$   
 $-378x + 152y = -604$
- ABCD is a cyclic quadrilateral (see Fig. 3.7). Find the angles of the cyclic quadrilateral.

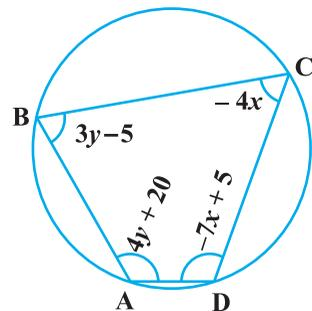


Fig. 3.7

\* These exercises are not from the examination point of view.

### 3.6 Summary

In this chapter, you have studied the following points:

- Two linear equations in the same two variables are called a pair of linear equations in two variables. The most general form of a pair of linear equations is

$$a_1x + b_1y + c_1 = 0$$

$$a_2x + b_2y + c_2 = 0$$

where  $a_1, a_2, b_1, b_2, c_1, c_2$  are real numbers, such that  $a_1^2 + b_1^2 \neq 0, a_2^2 + b_2^2 \neq 0$ .

- A pair of linear equations in two variables can be represented, and solved, by the:
  - graphical method
  - algebraic method
- Graphical Method :

The graph of a pair of linear equations in two variables is represented by two lines.

- If the lines intersect at a point, then that point gives the unique solution of the two equations. In this case, the pair of equations is **consistent**.
  - If the lines coincide, then there are infinitely many solutions — each point on the line being a solution. In this case, the pair of equations is **dependent (consistent)**.
  - If the lines are parallel, then the pair of equations has no solution. In this case, the pair of equations is **inconsistent**.
- Algebraic Methods : We have discussed the following methods for finding the solution(s) of a pair of linear equations :
    - Substitution Method
    - Elimination Method
    - Cross-multiplication Method
  - If a pair of linear equations is given by  $a_1x + b_1y + c_1 = 0$  and  $a_2x + b_2y + c_2 = 0$ , then the following situations can arise :

- $\frac{a_1}{a_2} \neq \frac{b_1}{b_2}$  : In this case, the pair of linear equations is consistent.

- $\frac{a_1}{a_2} = \frac{b_1}{b_2} \neq \frac{c_1}{c_2}$  : In this case, the pair of linear equations is inconsistent.

- $\frac{a_1}{a_2} = \frac{b_1}{b_2} = \frac{c_1}{c_2}$  : In this case, the pair of linear equations is dependent and consistent.

- There are several situations which can be mathematically represented by two equations that are not linear to start with. But we alter them so that they are reduced to a pair of linear equations.



1062CH04

# QUADRATIC EQUATIONS

# 4

## 4.1 Introduction

In Chapter 2, you have studied different types of polynomials. One type was the quadratic polynomial of the form  $ax^2 + bx + c$ ,  $a \neq 0$ . When we equate this polynomial to zero, we get a quadratic equation. Quadratic equations come up when we deal with many real-life situations. For instance, suppose a charity trust decides to build a prayer hall having a carpet area of 300 square metres with its length one metre more than twice its breadth. What should be the length and breadth of the hall? Suppose the breadth of the hall is  $x$  metres. Then, its length should be  $(2x + 1)$  metres. We can depict this information pictorially as shown in Fig. 4.1.

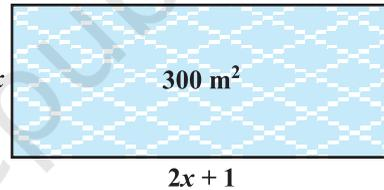


Fig. 4.1

Now, area of the hall =  $(2x + 1) \cdot x \text{ m}^2 = (2x^2 + x) \text{ m}^2$

So,  $2x^2 + x = 300$  (Given)

Therefore,  $2x^2 + x - 300 = 0$

So, the breadth of the hall should satisfy the equation  $2x^2 + x - 300 = 0$  which is a quadratic equation.

Many people believe that Babylonians were the first to solve quadratic equations. For instance, they knew how to find two positive numbers with a given positive sum and a given positive product, and this problem is equivalent to solving a quadratic equation of the form  $x^2 - px + q = 0$ . Greek mathematician Euclid developed a geometrical approach for finding out lengths which, in our present day terminology, are solutions of quadratic equations. Solving of quadratic equations, in general form, is often credited to ancient Indian mathematicians. In fact, Brahmagupta (C.E.598–665) gave an explicit formula to solve a quadratic equation of the form  $ax^2 + bx = c$ . Later,

Sridharacharya (C.E. 1025) derived a formula, now known as the quadratic formula, (as quoted by Bhaskara II) for solving a quadratic equation by the method of completing the square. An Arab mathematician Al-Khwarizmi (about C.E. 800) also studied quadratic equations of different types. Abraham bar Hiyya Ha-Nasi, in his book 'Liber embadorum' published in Europe in C.E. 1145 gave complete solutions of different quadratic equations.

In this chapter, you will study quadratic equations, and various ways of finding their roots. You will also see some applications of quadratic equations in daily life situations.

## 4.2 Quadratic Equations

A quadratic equation in the variable  $x$  is an equation of the form  $ax^2 + bx + c = 0$ , where  $a, b, c$  are real numbers,  $a \neq 0$ . For example,  $2x^2 + x - 300 = 0$  is a quadratic equation. Similarly,  $2x^2 - 3x + 1 = 0$ ,  $4x - 3x^2 + 2 = 0$  and  $1 - x^2 + 300 = 0$  are also quadratic equations.

In fact, any equation of the form  $p(x) = 0$ , where  $p(x)$  is a polynomial of degree 2, is a quadratic equation. But when we write the terms of  $p(x)$  in descending order of their degrees, then we get the standard form of the equation. That is,  $ax^2 + bx + c = 0$ ,  $a \neq 0$  is called the **standard form of a quadratic equation**.

Quadratic equations arise in several situations in the world around us and in different fields of mathematics. Let us consider a few examples.

**Example 1 :** Represent the following situations mathematically:

- (i) John and Jivanti together have 45 marbles. Both of them lost 5 marbles each, and the product of the number of marbles they now have is 124. We would like to find out how many marbles they had to start with.
- (ii) A cottage industry produces a certain number of toys in a day. The cost of production of each toy (in rupees) was found to be 55 minus the number of toys produced in a day. On a particular day, the total cost of production was ₹ 750. We would like to find out the number of toys produced on that day.

**Solution :**

- (i) Let the number of marbles John had be  $x$ .

Then the number of marbles Jivanti had =  $45 - x$  (Why?).

The number of marbles left with John, when he lost 5 marbles =  $x - 5$

The number of marbles left with Jivanti, when she lost 5 marbles =  $45 - x - 5$   
=  $40 - x$

$$\begin{aligned}\text{Therefore, their product} &= (x - 5)(40 - x) \\ &= 40x - x^2 - 200 + 5x \\ &= -x^2 + 45x - 200\end{aligned}$$

$$\text{So, } -x^2 + 45x - 200 = 124 \quad (\text{Given that product} = 124)$$

$$\text{i.e., } -x^2 + 45x - 324 = 0$$

$$\text{i.e., } x^2 - 45x + 324 = 0$$

Therefore, the number of marbles John had, satisfies the quadratic equation

$$x^2 - 45x + 324 = 0$$

which is the required representation of the problem mathematically.

(ii) Let the number of toys produced on that day be  $x$ .

Therefore, the cost of production (in rupees) of each toy that day =  $55 - x$

So, the total cost of production (in rupees) that day =  $x(55 - x)$

$$\text{Therefore, } x(55 - x) = 750$$

$$\text{i.e., } 55x - x^2 = 750$$

$$\text{i.e., } -x^2 + 55x - 750 = 0$$

$$\text{i.e., } x^2 - 55x + 750 = 0$$

Therefore, the number of toys produced that day satisfies the quadratic equation

$$x^2 - 55x + 750 = 0$$

which is the required representation of the problem mathematically.

**Example 2 :** Check whether the following are quadratic equations:

$$(i) (x - 2)^2 + 1 = 2x - 3$$

$$(ii) x(x + 1) + 8 = (x + 2)(x - 2)$$

$$(iii) x(2x + 3) = x^2 + 1$$

$$(iv) (x + 2)^3 = x^3 - 4$$

**Solution :**

$$(i) \text{ LHS} = (x - 2)^2 + 1 = x^2 - 4x + 4 + 1 = x^2 - 4x + 5$$

Therefore,  $(x - 2)^2 + 1 = 2x - 3$  can be rewritten as

$$x^2 - 4x + 5 = 2x - 3$$

$$\text{i.e., } x^2 - 6x + 8 = 0$$

It is of the form  $ax^2 + bx + c = 0$ .

Therefore, the given equation is a quadratic equation.

(ii) Since  $x(x + 1) + 8 = x^2 + x + 8$  and  $(x + 2)(x - 2) = x^2 - 4$

Therefore,  $x^2 + x + 8 = x^2 - 4$

i.e.,  $x + 12 = 0$

It is not of the form  $ax^2 + bx + c = 0$ .

Therefore, the given equation is not a quadratic equation.

(iii) Here, LHS =  $x(2x + 3) = 2x^2 + 3x$

So,  $x(2x + 3) = x^2 + 1$  can be rewritten as

$$2x^2 + 3x = x^2 + 1$$

Therefore, we get  $x^2 + 3x - 1 = 0$

It is of the form  $ax^2 + bx + c = 0$ .

So, the given equation is a quadratic equation.

(iv) Here, LHS =  $(x + 2)^3 = x^3 + 6x^2 + 12x + 8$

Therefore,  $(x + 2)^3 = x^3 - 4$  can be rewritten as

$$x^3 + 6x^2 + 12x + 8 = x^3 - 4$$

i.e.,  $6x^2 + 12x + 12 = 0$  or,  $x^2 + 2x + 2 = 0$

It is of the form  $ax^2 + bx + c = 0$ .

So, the given equation is a quadratic equation.

**Remark :** Be careful! In (ii) above, the given equation appears to be a quadratic equation, but it is not a quadratic equation.

In (iv) above, the given equation appears to be a cubic equation (an equation of degree 3) and not a quadratic equation. But it turns out to be a quadratic equation. As you can see, often we need to simplify the given equation before deciding whether it is quadratic or not.

### EXERCISE 4.1

1. Check whether the following are quadratic equations :

(i)  $(x + 1)^2 = 2(x - 3)$

(ii)  $x^2 - 2x = (-2)(3 - x)$

(iii)  $(x - 2)(x + 1) = (x - 1)(x + 3)$

(iv)  $(x - 3)(2x + 1) = x(x + 5)$

(v)  $(2x - 1)(x - 3) = (x + 5)(x - 1)$

(vi)  $x^2 + 3x + 1 = (x - 2)^2$

(vii)  $(x + 2)^3 = 2x(x^2 - 1)$

(viii)  $x^3 - 4x^2 - x + 1 = (x - 2)^3$

2. Represent the following situations in the form of quadratic equations :

(i) The area of a rectangular plot is  $528 \text{ m}^2$ . The length of the plot (in metres) is one more than twice its breadth. We need to find the length and breadth of the plot.

- (ii) The product of two consecutive positive integers is 306. We need to find the integers.
- (iii) Rohan's mother is 26 years older than him. The product of their ages (in years) 3 years from now will be 360. We would like to find Rohan's present age.
- (iv) A train travels a distance of 480 km at a uniform speed. If the speed had been 8 km/h less, then it would have taken 3 hours more to cover the same distance. We need to find the speed of the train.

### 4.3 Solution of a Quadratic Equation by Factorisation

Consider the quadratic equation  $2x^2 - 3x + 1 = 0$ . If we replace  $x$  by 1 on the LHS of this equation, we get  $(2 \times 1^2) - (3 \times 1) + 1 = 0 = \text{RHS}$  of the equation. We say that 1 is a root of the quadratic equation  $2x^2 - 3x + 1 = 0$ . This also means that 1 is a zero of the quadratic polynomial  $2x^2 - 3x + 1$ .

In general, a real number  $\alpha$  is called a root of the quadratic equation  $ax^2 + bx + c = 0$ ,  $a \neq 0$  if  $a\alpha^2 + b\alpha + c = 0$ . We also say that  $x = \alpha$  is a **solution of the quadratic equation**, or that  $\alpha$  **satisfies the quadratic equation**. Note that **the zeroes of the quadratic polynomial  $ax^2 + bx + c$  and the roots of the quadratic equation  $ax^2 + bx + c = 0$  are the same**.

You have observed, in Chapter 2, that a quadratic polynomial can have at most two zeroes. So, any quadratic equation can have at most two roots.

You have learnt in Class IX, how to factorise quadratic polynomials by splitting their middle terms. We shall use this knowledge for finding the roots of a quadratic equation. Let us see how.

**Example 3 :** Find the roots of the equation  $2x^2 - 5x + 3 = 0$ , by factorisation.

**Solution :** Let us first split the middle term  $-5x$  as  $-2x - 3x$  [because  $(-2x) \times (-3x) = 6x^2 = (2x^2) \times 3$ ].

$$\text{So, } 2x^2 - 5x + 3 = 2x^2 - 2x - 3x + 3 = 2x(x - 1) - 3(x - 1) = (2x - 3)(x - 1)$$

$$\text{Now, } 2x^2 - 5x + 3 = 0 \text{ can be rewritten as } (2x - 3)(x - 1) = 0.$$

So, the values of  $x$  for which  $2x^2 - 5x + 3 = 0$  are the same for which  $(2x - 3)(x - 1) = 0$ , i.e., either  $2x - 3 = 0$  or  $x - 1 = 0$ .

$$\text{Now, } 2x - 3 = 0 \text{ gives } x = \frac{3}{2} \text{ and } x - 1 = 0 \text{ gives } x = 1.$$

So,  $x = \frac{3}{2}$  and  $x = 1$  are the solutions of the equation.

In other words, 1 and  $\frac{3}{2}$  are the roots of the equation  $2x^2 - 5x + 3 = 0$ .

**Verify** that these are the roots of the given equation.

**Note that we have found the roots of  $2x^2 - 5x + 3 = 0$  by factorising  $2x^2 - 5x + 3$  into two linear factors and equating each factor to zero.**

**Example 4 :** Find the roots of the quadratic equation  $6x^2 - x - 2 = 0$ .

**Solution :** We have

$$\begin{aligned} 6x^2 - x - 2 &= 6x^2 + 3x - 4x - 2 \\ &= 3x(2x + 1) - 2(2x + 1) \\ &= (3x - 2)(2x + 1) \end{aligned}$$

The roots of  $6x^2 - x - 2 = 0$  are the values of  $x$  for which  $(3x - 2)(2x + 1) = 0$   
Therefore,  $3x - 2 = 0$  or  $2x + 1 = 0$ ,

i.e., 
$$x = \frac{2}{3} \quad \text{or} \quad x = -\frac{1}{2}$$

Therefore, the roots of  $6x^2 - x - 2 = 0$  are  $\frac{2}{3}$  and  $-\frac{1}{2}$ .

We verify the roots, by checking that  $\frac{2}{3}$  and  $-\frac{1}{2}$  satisfy  $6x^2 - x - 2 = 0$ .

**Example 5 :** Find the roots of the quadratic equation  $3x^2 - 2\sqrt{6}x + 2 = 0$ .

**Solution :**

$$\begin{aligned} 3x^2 - 2\sqrt{6}x + 2 &= 3x^2 - \sqrt{6}x - \sqrt{6}x + 2 \\ &= \sqrt{3}x(\sqrt{3}x - \sqrt{2}) - \sqrt{2}(\sqrt{3}x - \sqrt{2}) \\ &= (\sqrt{3}x - \sqrt{2})(\sqrt{3}x - \sqrt{2}) \end{aligned}$$

So, the roots of the equation are the values of  $x$  for which

$$(\sqrt{3}x - \sqrt{2})(\sqrt{3}x - \sqrt{2}) = 0$$

Now,  $\sqrt{3}x - \sqrt{2} = 0$  for  $x = \sqrt{\frac{2}{3}}$ .

So, this root is repeated twice, one for each repeated factor  $\sqrt{3}x - \sqrt{2}$ .

Therefore, the roots of  $3x^2 - 2\sqrt{6}x + 2 = 0$  are  $\sqrt{\frac{2}{3}}$ ,  $\sqrt{\frac{2}{3}}$ .

**Example 6 :** Find the dimensions of the prayer hall discussed in Section 4.1.

**Solution :** In Section 4.1, we found that if the breadth of the hall is  $x$  m, then  $x$  satisfies the equation  $2x^2 + x - 300 = 0$ . Applying the factorisation method, we write this equation as

$$2x^2 - 24x + 25x - 300 = 0$$

$$2x(x - 12) + 25(x - 12) = 0$$

i.e.,  $(x - 12)(2x + 25) = 0$

So, the roots of the given equation are  $x = 12$  or  $x = -12.5$ . Since  $x$  is the breadth of the hall, it cannot be negative.

Thus, the breadth of the hall is 12 m. Its length =  $2x + 1 = 25$  m.

### EXERCISE 4.2

1. Find the roots of the following quadratic equations by factorisation:

(i)  $x^2 - 3x - 10 = 0$

(ii)  $2x^2 + x - 6 = 0$

(iii)  $\sqrt{2}x^2 + 7x + 5\sqrt{2} = 0$

(iv)  $2x^2 - x + \frac{1}{8} = 0$

(v)  $100x^2 - 20x + 1 = 0$

- Solve the problems given in Example 1.
- Find two numbers whose sum is 27 and product is 182.
- Find two consecutive positive integers, sum of whose squares is 365.
- The altitude of a right triangle is 7 cm less than its base. If the hypotenuse is 13 cm, find the other two sides.
- A cottage industry produces a certain number of pottery articles in a day. It was observed on a particular day that the cost of production of each article (in rupees) was 3 more than twice the number of articles produced on that day. If the total cost of production on that day was ₹ 90, find the number of articles produced and the cost of each article.

### 4.4 Solution of a Quadratic Equation by Completing the Square

In the previous section, you have learnt one method of obtaining the roots of a quadratic equation. In this section, we shall study another method.

Consider the following situation:

The product of Sunita's age (in years) two years ago and her age four years from now is one more than twice her present age. What is her present age?

To answer this, let her present age (in years) be  $x$ . Then the product of her ages two years ago and four years from now is  $(x - 2)(x + 4)$ .

Therefore,  $(x - 2)(x + 4) = 2x + 1$

i.e.,  $x^2 + 2x - 8 = 2x + 1$

i.e.,  $x^2 - 9 = 0$

So, Sunita's present age satisfies the quadratic equation  $x^2 - 9 = 0$ .

We can write this as  $x^2 = 9$ . Taking square roots, we get  $x = 3$  or  $x = -3$ . Since the age is a positive number,  $x = 3$ .

So, Sunita's present age is 3 years.

Now consider the quadratic equation  $(x + 2)^2 - 9 = 0$ . To solve it, we can write it as  $(x + 2)^2 = 9$ . Taking square roots, we get  $x + 2 = 3$  or  $x + 2 = -3$ .

Therefore,  $x = 1$  or  $x = -5$

So, the roots of the equation  $(x + 2)^2 - 9 = 0$  are 1 and  $-5$ .

In both the examples above, the term containing  $x$  is completely inside a square, and we found the roots easily by taking the square roots. But, what happens if we are asked to solve the equation  $x^2 + 4x - 5 = 0$ ? We would probably apply factorisation to do so, unless we realise (somehow!) that  $x^2 + 4x - 5 = (x + 2)^2 - 9$ .

So, solving  $x^2 + 4x - 5 = 0$  is equivalent to solving  $(x + 2)^2 - 9 = 0$ , which we have seen is very quick to do. In fact, we can convert any quadratic equation to the form  $(x + a)^2 - b^2 = 0$  and then we can easily find its roots. Let us see if this is possible. Look at Fig. 4.2.

In this figure, we can see how  $x^2 + 4x$  is being converted to  $(x + 2)^2 - 4$ .

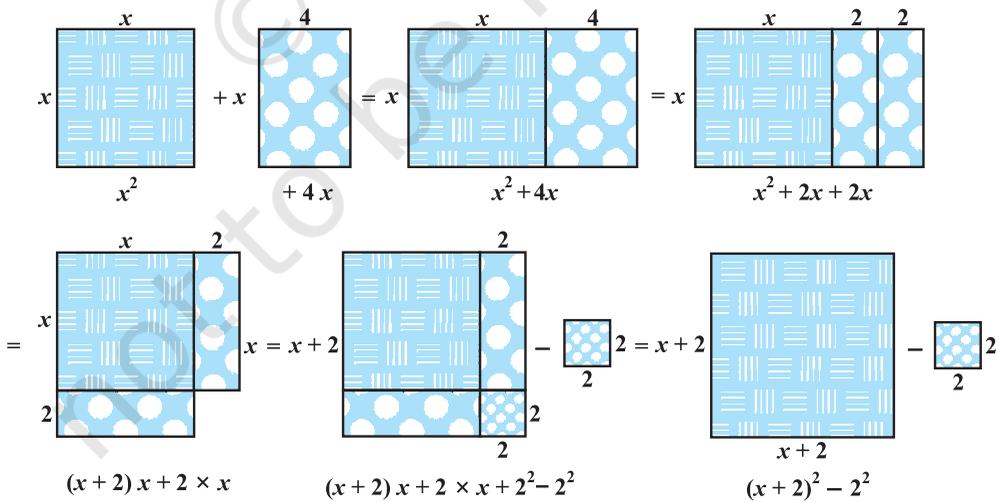


Fig. 4.2

The process is as follows:

$$\begin{aligned}
 x^2 + 4x &= \left(x^2 + \frac{4}{2}x\right) + \frac{4}{2}x \\
 &= x^2 + 2x + 2x \\
 &= (x + 2)x + 2 \times x \\
 &= (x + 2)x + 2 \times x + 2 \times 2 - 2 \times 2 \\
 &= (x + 2)x + (x + 2) \times 2 - 2 \times 2 \\
 &= (x + 2)(x + 2) - 2^2 \\
 &= (x + 2)^2 - 4
 \end{aligned}$$

So,  $x^2 + 4x - 5 = (x + 2)^2 - 4 - 5 = (x + 2)^2 - 9$

So,  $x^2 + 4x - 5 = 0$  can be written as  $(x + 2)^2 - 9 = 0$  by this process of completing the square. This is known as the **method of completing the square**.

In brief, this can be shown as follows:

$$x^2 + 4x = \left(x + \frac{4}{2}\right)^2 - \left(\frac{4}{2}\right)^2 = \left(x + \frac{4}{2}\right)^2 - 4$$

So,  $x^2 + 4x - 5 = 0$  can be rewritten as

$$\left(x + \frac{4}{2}\right)^2 - 4 - 5 = 0$$

i.e.,  $(x + 2)^2 - 9 = 0$

Consider now the equation  $3x^2 - 5x + 2 = 0$ . Note that the coefficient of  $x^2$  is not a perfect square. So, we multiply the equation throughout by 3 to get

$$9x^2 - 15x + 6 = 0$$

Now,  $9x^2 - 15x + 6 = (3x)^2 - 2 \times 3x \times \frac{5}{2} + 6$

$$= (3x)^2 - 2 \times 3x \times \frac{5}{2} + \left(\frac{5}{2}\right)^2 - \left(\frac{5}{2}\right)^2 + 6$$

$$= \left(3x - \frac{5}{2}\right)^2 - \frac{25}{4} + 6 = \left(3x - \frac{5}{2}\right)^2 - \frac{1}{4}$$

So,  $9x^2 - 15x + 6 = 0$  can be written as

$$\left(3x - \frac{5}{2}\right)^2 - \frac{1}{4} = 0$$

i.e., 
$$\left(3x - \frac{5}{2}\right)^2 = \frac{1}{4}$$

So, the solutions of  $9x^2 - 15x + 6 = 0$  are the same as those of  $\left(3x - \frac{5}{2}\right)^2 = \frac{1}{4}$ .

i.e., 
$$3x - \frac{5}{2} = \frac{1}{2} \quad \text{or} \quad 3x - \frac{5}{2} = -\frac{1}{2}$$

(We can also write this as  $3x - \frac{5}{2} = \pm \frac{1}{2}$ , where ‘ $\pm$ ’ denotes ‘plus minus’.)

Thus, 
$$3x = \frac{5}{2} + \frac{1}{2} \quad \text{or} \quad 3x = \frac{5}{2} - \frac{1}{2}$$

So, 
$$x = \frac{5}{6} + \frac{1}{6} \quad \text{or} \quad x = \frac{5}{6} - \frac{1}{6}$$

Therefore, 
$$x = 1 \quad \text{or} \quad x = \frac{4}{6}$$

i.e., 
$$x = 1 \quad \text{or} \quad x = \frac{2}{3}$$

Therefore, the roots of the given equation are 1 and  $\frac{2}{3}$ .

**Remark :** Another way of showing this process is as follows :

The equation 
$$3x^2 - 5x + 2 = 0$$

is the same as

$$x^2 - \frac{5}{3}x + \frac{2}{3} = 0$$

Now, 
$$x^2 - \frac{5}{3}x + \frac{2}{3} = \left\{x - \frac{1}{2}\left(\frac{5}{3}\right)\right\}^2 - \left\{\frac{1}{2}\left(\frac{5}{3}\right)\right\}^2 + \frac{2}{3}$$

$$\begin{aligned}
 &= \left(x - \frac{5}{6}\right)^2 + \frac{2}{3} - \frac{25}{36} \\
 &= \left(x - \frac{5}{6}\right)^2 - \frac{1}{36} = \left(x - \frac{5}{6}\right)^2 - \left(\frac{1}{6}\right)^2
 \end{aligned}$$

So, the solutions of  $3x^2 - 5x + 2 = 0$  are the same as those of  $\left(x - \frac{5}{6}\right)^2 - \left(\frac{1}{6}\right)^2 = 0$ ,

which are  $x - \frac{5}{6} = \pm \frac{1}{6}$ , i.e.,  $x = \frac{5}{6} + \frac{1}{6} = 1$  and  $x = \frac{5}{6} - \frac{1}{6} = \frac{2}{3}$ .

Let us consider some examples to illustrate the above process.

**Example 7 :** Solve the equation given in Example 3 by the method of completing the square.

**Solution :** The equation  $2x^2 - 5x + 3 = 0$  is the same as  $x^2 - \frac{5}{2}x + \frac{3}{2} = 0$ .

Now,

$$x^2 - \frac{5}{2}x + \frac{3}{2} = \left(x - \frac{5}{4}\right)^2 - \left(\frac{5}{4}\right)^2 + \frac{3}{2} = \left(x - \frac{5}{4}\right)^2 - \frac{1}{16}$$

Therefore,  $2x^2 - 5x + 3 = 0$  can be written as  $\left(x - \frac{5}{4}\right)^2 - \frac{1}{16} = 0$ .

So, the roots of the equation  $2x^2 - 5x + 3 = 0$  are exactly the same as those of

$$\left(x - \frac{5}{4}\right)^2 - \frac{1}{16} = 0. \text{ Now, } \left(x - \frac{5}{4}\right)^2 - \frac{1}{16} = 0 \text{ is the same as } \left(x - \frac{5}{4}\right)^2 = \frac{1}{16}$$

Therefore,

$$x - \frac{5}{4} = \pm \frac{1}{4}$$

i.e.,

$$x = \frac{5}{4} \pm \frac{1}{4}$$

i.e.,

$$x = \frac{5}{4} + \frac{1}{4} \text{ or } x = \frac{5}{4} - \frac{1}{4}$$

i.e.,

$$x = \frac{3}{2} \text{ or } x = 1$$

Therefore, the solutions of the equations are  $x = \frac{3}{2}$  and 1.

Let us **verify** our solutions.

Putting  $x = \frac{3}{2}$  in  $2x^2 - 5x + 3 = 0$ , we get  $2\left(\frac{3}{2}\right)^2 - 5\left(\frac{3}{2}\right) + 3 = 0$ , which is correct. Similarly, you can verify that  $x = 1$  also satisfies the given equation.

In Example 7, we divided the equation  $2x^2 - 5x + 3 = 0$  throughout by 2 to get  $x^2 - \frac{5}{2}x + \frac{3}{2} = 0$  to make the first term a perfect square and then completed the square. Instead, we can multiply throughout by 2 to make the first term as  $4x^2 = (2x)^2$  and then complete the square.

This method is illustrated in the next example.

**Example 8 :** Find the roots of the equation  $5x^2 - 6x - 2 = 0$  by the method of completing the square.

**Solution :** Multiplying the equation throughout by 5, we get

$$25x^2 - 30x - 10 = 0$$

This is the same as

$$(5x)^2 - 2 \times (5x) \times 3 + 3^2 - 3^2 - 10 = 0$$

i.e.,  $(5x - 3)^2 - 9 - 10 = 0$

i.e.,  $(5x - 3)^2 - 19 = 0$

i.e.,  $(5x - 3)^2 = 19$

i.e.,  $5x - 3 = \pm\sqrt{19}$

i.e.,  $5x = 3 \pm \sqrt{19}$

So,  $x = \frac{3 \pm \sqrt{19}}{5}$

Therefore, the roots are  $\frac{3 + \sqrt{19}}{5}$  and  $\frac{3 - \sqrt{19}}{5}$ .

Verify that the roots are  $\frac{3 + \sqrt{19}}{5}$  and  $\frac{3 - \sqrt{19}}{5}$ .

**Example 9 :** Find the roots of  $4x^2 + 3x + 5 = 0$  by the method of completing the square.

**Solution :** Note that  $4x^2 + 3x + 5 = 0$  is the same as

$$(2x)^2 + 2 \times (2x) \times \frac{3}{4} + \left(\frac{3}{4}\right)^2 - \left(\frac{3}{4}\right)^2 + 5 = 0$$

i.e., 
$$\left(2x + \frac{3}{4}\right)^2 - \frac{9}{16} + 5 = 0$$

i.e., 
$$\left(2x + \frac{3}{4}\right)^2 + \frac{71}{16} = 0$$

i.e., 
$$\left(2x + \frac{3}{4}\right)^2 = \frac{-71}{16} < 0$$

But  $\left(2x + \frac{3}{4}\right)^2$  cannot be negative for any real value of  $x$  (Why?). So, there is no real value of  $x$  satisfying the given equation. Therefore, the given equation has no *real roots*.

Now, you have seen several examples of the use of the method of completing the square. So, let us give this method in general.

Consider the quadratic equation  $ax^2 + bx + c = 0$  ( $a \neq 0$ ). Dividing throughout by  $a$ , we get

$$x^2 + \frac{b}{a}x + \frac{c}{a} = 0$$

This is the same as 
$$\left(x + \frac{b}{2a}\right)^2 - \left(\frac{b}{2a}\right)^2 + \frac{c}{a} = 0$$

i.e., 
$$\left(x + \frac{b}{2a}\right)^2 - \frac{b^2 - 4ac}{4a^2} = 0$$

So, the roots of the given equation are the same as those of

$$\left(x + \frac{b}{2a}\right)^2 - \frac{b^2 - 4ac}{4a^2} = 0, \text{ i.e., those of } \left(x + \frac{b}{2a}\right)^2 = \frac{b^2 - 4ac}{4a^2} \quad (1)$$

If  $b^2 - 4ac \geq 0$ , then by taking the square roots in (1), we get

$$x + \frac{b}{2a} = \frac{\pm \sqrt{b^2 - 4ac}}{2a}$$

Therefore,

$$x = \frac{-b \pm \sqrt{b^2 - 4ac}}{2a}$$

So, the roots of  $ax^2 + bx + c = 0$  are  $\frac{-b + \sqrt{b^2 - 4ac}}{2a}$  and  $\frac{-b - \sqrt{b^2 - 4ac}}{2a}$ , if  $b^2 - 4ac \geq 0$ . If  $b^2 - 4ac < 0$ , the equation will have no real roots. (Why?)

**Thus, if  $b^2 - 4ac \geq 0$ , then the roots of the quadratic equation  $ax^2 + bx + c = 0$  are given by  $\frac{-b \pm \sqrt{b^2 - 4ac}}{2a}$**

This formula for finding the roots of a quadratic equation is known as the **quadratic formula**.

Let us consider some examples for illustrating the use of the quadratic formula.

**Example 10 :** Solve Q. 2(i) of Exercise 4.1 by using the quadratic formula.

**Solution :** Let the breadth of the plot be  $x$  metres. Then the length is  $(2x + 1)$  metres. Then we are given that  $x(2x + 1) = 528$ , i.e.,  $2x^2 + x - 528 = 0$ .

This is of the form  $ax^2 + bx + c = 0$ , where  $a = 2$ ,  $b = 1$ ,  $c = -528$ .

So, the quadratic formula gives us the solution as

$$x = \frac{-1 \pm \sqrt{1 + 4(2)(528)}}{4} = \frac{-1 \pm \sqrt{4225}}{4} = \frac{-1 \pm 65}{4}$$

i.e.,  $x = \frac{64}{4}$  or  $x = \frac{-66}{4}$

i.e.,  $x = 16$  or  $x = -\frac{33}{2}$

Since  $x$  cannot be negative, being a dimension, the breadth of the plot is 16 metres and hence, the length of the plot is 33m.

You should verify that these values satisfy the conditions of the problem.

**Example 11 :** Find two consecutive odd positive integers, sum of whose squares is 290.

**Solution :** Let the smaller of the two consecutive odd positive integers be  $x$ . Then, the second integer will be  $x + 2$ . According to the question,

$$x^2 + (x + 2)^2 = 290$$

i.e.,  $x^2 + x^2 + 4x + 4 = 290$

i.e.,  $2x^2 + 4x - 286 = 0$

i.e.,  $x^2 + 2x - 143 = 0$

which is a quadratic equation in  $x$ .

Using the quadratic formula, we get

$$x = \frac{-2 \pm \sqrt{4 + 572}}{2} = \frac{-2 \pm \sqrt{576}}{2} = \frac{-2 \pm 24}{2}$$

i.e.,  $x = 11$  or  $x = -13$

But  $x$  is given to be an odd positive integer. Therefore,  $x \neq -13$ ,  $x = 11$ .

Thus, the two consecutive odd integers are 11 and 13.

Check :  $11^2 + 13^2 = 121 + 169 = 290$ .

**Example 12 :** A rectangular park is to be designed whose breadth is 3 m less than its length. Its area is to be 4 square metres more than the area of a park that has already been made in the shape of an isosceles triangle with its base as the breadth of the rectangular park and of altitude 12 m (see Fig. 4.3). Find its length and breadth.

**Solution :** Let the breadth of the rectangular park be  $x$  m.

So, its length =  $(x + 3)$  m.

Therefore, the area of the rectangular park =  $x(x + 3)$  m<sup>2</sup> =  $(x^2 + 3x)$  m<sup>2</sup>.

Now, base of the isosceles triangle =  $x$  m.

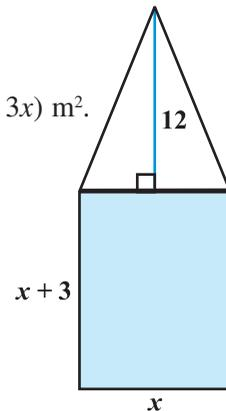
Therefore, its area =  $\frac{1}{2} \times x \times 12 = 6x$  m<sup>2</sup>.

According to our requirements,

$$x^2 + 3x = 6x + 4$$

i.e.,  $x^2 - 3x - 4 = 0$

Using the quadratic formula, we get



**Fig. 4.3**

$$x = \frac{3 \pm \sqrt{25}}{2} = \frac{3 \pm 5}{2} = 4 \text{ or } -1$$

But  $x \neq -1$  (Why?). Therefore,  $x = 4$ .

So, the breadth of the park = 4m and its length will be 7m.

**Verification :** Area of rectangular park = 28 m<sup>2</sup>,

$$\text{area of triangular park} = 24 \text{ m}^2 = (28 - 4) \text{ m}^2$$

**Example 13 :** Find the roots of the following quadratic equations, if they exist, using the quadratic formula:

(i)  $3x^2 - 5x + 2 = 0$                       (ii)  $x^2 + 4x + 5 = 0$                       (iii)  $2x^2 - 2\sqrt{2}x + 1 = 0$

**Solution :**

(i)  $3x^2 - 5x + 2 = 0$ . Here,  $a = 3$ ,  $b = -5$ ,  $c = 2$ . So,  $b^2 - 4ac = 25 - 24 = 1 > 0$ .

Therefore,  $x = \frac{5 \pm \sqrt{1}}{6} = \frac{5 \pm 1}{6}$ , i.e.,  $x = 1$  or  $x = \frac{2}{3}$

So, the roots are  $\frac{2}{3}$  and 1.

(ii)  $x^2 + 4x + 5 = 0$ . Here,  $a = 1$ ,  $b = 4$ ,  $c = 5$ . So,  $b^2 - 4ac = 16 - 20 = -4 < 0$ .

Since the square of a real number cannot be negative, therefore  $\sqrt{b^2 - 4ac}$  will not have any real value.

So, there are no real roots for the given equation.

(iii)  $2x^2 - 2\sqrt{2}x + 1 = 0$ . Here,  $a = 2$ ,  $b = -2\sqrt{2}$ ,  $c = 1$ .

So,  $b^2 - 4ac = 8 - 8 = 0$

Therefore,  $x = \frac{2\sqrt{2} \pm \sqrt{0}}{4} = \frac{\sqrt{2}}{2} \pm 0$ , i.e.,  $x = \frac{1}{\sqrt{2}}$ .

So, the roots are  $\frac{1}{\sqrt{2}}$ ,  $\frac{1}{\sqrt{2}}$ .

**Example 14 :** Find the roots of the following equations:

$$(i) \quad x + \frac{1}{x} = 3, x \neq 0$$

$$(ii) \quad \frac{1}{x} - \frac{1}{x-2} = 3, x \neq 0, 2$$

**Solution :**

(i)  $x + \frac{1}{x} = 3$ . Multiplying throughout by  $x$ , we get

$$x^2 + 1 = 3x$$

i.e.,  $x^2 - 3x + 1 = 0$ , which is a quadratic equation.

Here,  $a = 1, b = -3, c = 1$

So,  $b^2 - 4ac = 9 - 4 = 5 > 0$

Therefore,  $x = \frac{3 \pm \sqrt{5}}{2}$  (Why?)

So, the roots are  $\frac{3 + \sqrt{5}}{2}$  and  $\frac{3 - \sqrt{5}}{2}$ .

(ii)  $\frac{1}{x} - \frac{1}{x-2} = 3, x \neq 0, 2$ .

As  $x \neq 0, 2$ , multiplying the equation by  $x(x-2)$ , we get

$$\begin{aligned} (x-2) - x &= 3x(x-2) \\ &= 3x^2 - 6x \end{aligned}$$

So, the given equation reduces to  $3x^2 - 6x + 2 = 0$ , which is a quadratic equation.

Here,  $a = 3, b = -6, c = 2$ . So,  $b^2 - 4ac = 36 - 24 = 12 > 0$

Therefore,  $x = \frac{6 \pm \sqrt{12}}{6} = \frac{6 \pm 2\sqrt{3}}{6} = \frac{3 \pm \sqrt{3}}{3}$ .

So, the roots are  $\frac{3 + \sqrt{3}}{3}$  and  $\frac{3 - \sqrt{3}}{3}$ .

**Example 15 :** A motor boat whose speed is 18 km/h in still water takes 1 hour more to go 24 km upstream than to return downstream to the same spot. Find the speed of the stream.

**Solution :** Let the speed of the stream be  $x$  km/h.

Therefore, the speed of the boat upstream =  $(18 - x)$  km/h and the speed of the boat downstream =  $(18 + x)$  km/h.

The time taken to go upstream =  $\frac{\text{distance}}{\text{speed}} = \frac{24}{18 - x}$  hours.

Similarly, the time taken to go downstream =  $\frac{24}{18 + x}$  hours.

According to the question,

$$\frac{24}{18 - x} - \frac{24}{18 + x} = 1$$

i.e.,  $24(18 + x) - 24(18 - x) = (18 - x)(18 + x)$

i.e.,  $x^2 + 48x - 324 = 0$

Using the quadratic formula, we get

$$\begin{aligned} x &= \frac{-48 \pm \sqrt{48^2 + 1296}}{2} = \frac{-48 \pm \sqrt{3600}}{2} \\ &= \frac{-48 \pm 60}{2} = 6 \text{ or } -54 \end{aligned}$$

Since  $x$  is the speed of the stream, it cannot be negative. So, we ignore the root  $x = -54$ . Therefore,  $x = 6$  gives the speed of the stream as 6 km/h.

### EXERCISE 4.3

- Find the roots of the following quadratic equations, if they exist, by the method of completing the square:
  - $2x^2 - 7x + 3 = 0$
  - $2x^2 + x - 4 = 0$
  - $4x^2 + 4\sqrt{3}x + 3 = 0$
  - $2x^2 + x + 4 = 0$
- Find the roots of the quadratic equations given in Q.1 above by applying the quadratic formula.

3. Find the roots of the following equations:

(i)  $x - \frac{1}{x} = 3, x \neq 0$

(ii)  $\frac{1}{x+4} - \frac{1}{x-7} = \frac{11}{30}, x \neq -4, 7$

4. The sum of the reciprocals of Rehman's ages, (in years) 3 years ago and 5 years from now is  $\frac{1}{3}$ . Find his present age.
5. In a class test, the sum of Shefali's marks in Mathematics and English is 30. Had she got 2 marks more in Mathematics and 3 marks less in English, the product of their marks would have been 210. Find her marks in the two subjects.
6. The diagonal of a rectangular field is 60 metres more than the shorter side. If the longer side is 30 metres more than the shorter side, find the sides of the field.
7. The difference of squares of two numbers is 180. The square of the smaller number is 8 times the larger number. Find the two numbers.
8. A train travels 360 km at a uniform speed. If the speed had been 5 km/h more, it would have taken 1 hour less for the same journey. Find the speed of the train.
9. Two water taps together can fill a tank in  $9\frac{3}{8}$  hours. The tap of larger diameter takes 10 hours less than the smaller one to fill the tank separately. Find the time in which each tap can separately fill the tank.
10. An express train takes 1 hour less than a passenger train to travel 132 km between Mysore and Bangalore (without taking into consideration the time they stop at intermediate stations). If the average speed of the express train is 11 km/h more than that of the passenger train, find the average speed of the two trains.
11. Sum of the areas of two squares is 468 m<sup>2</sup>. If the difference of their perimeters is 24 m, find the sides of the two squares.

#### 4.5 Nature of Roots

In the previous section, you have seen that the roots of the equation  $ax^2 + bx + c = 0$  are given by

$$x = \frac{-b \pm \sqrt{b^2 - 4ac}}{2a}$$

If  $b^2 - 4ac > 0$ , we get two distinct real roots  $-\frac{b}{2a} + \frac{\sqrt{b^2 - 4ac}}{2a}$  and  $-\frac{b}{2a} - \frac{\sqrt{b^2 - 4ac}}{2a}$ .

If  $b^2 - 4ac = 0$ , then  $x = -\frac{b}{2a} \pm 0$ , i.e.,  $x = -\frac{b}{2a}$  or  $-\frac{b}{2a}$ .

So, the roots of the equation  $ax^2 + bx + c = 0$  are both  $-\frac{b}{2a}$ .

Therefore, we say that the quadratic equation  $ax^2 + bx + c = 0$  has two equal real roots in this case.

If  $b^2 - 4ac < 0$ , then there is no real number whose square is  $b^2 - 4ac$ . Therefore, there are no real roots for the given quadratic equation in this case.

Since  $b^2 - 4ac$  determines whether the quadratic equation  $ax^2 + bx + c = 0$  has real roots or not,  $b^2 - 4ac$  is called the **discriminant** of this quadratic equation.

So, a quadratic equation  $ax^2 + bx + c = 0$  has

- (i) two distinct real roots, if  $b^2 - 4ac > 0$ ,
- (ii) two equal real roots, if  $b^2 - 4ac = 0$ ,
- (iii) no real roots, if  $b^2 - 4ac < 0$ .

Let us consider some examples.

**Example 16 :** Find the discriminant of the quadratic equation  $2x^2 - 4x + 3 = 0$ , and hence find the nature of its roots.

**Solution :** The given equation is of the form  $ax^2 + bx + c = 0$ , where  $a = 2$ ,  $b = -4$  and  $c = 3$ . Therefore, the discriminant

$$b^2 - 4ac = (-4)^2 - (4 \times 2 \times 3) = 16 - 24 = -8 < 0$$

So, the given equation has no real roots.

**Example 17 :** A pole has to be erected at a point on the boundary of a circular park of diameter 13 metres in such a way that the differences of its distances from two diametrically opposite fixed gates A and B on the boundary is 7 metres. Is it possible to do so? If yes, at what distances from the two gates should the pole be erected?

**Solution :** Let us first draw the diagram (see Fig. 4.4).

Let P be the required location of the pole. Let the distance of the pole from the gate B be  $x$  m, i.e.,  $BP = x$  m. Now the difference of the distances of the pole from the two gates =  $AP - BP$  (or,  $BP - AP$ ) = 7 m. Therefore,  $AP = (x + 7)$  m.

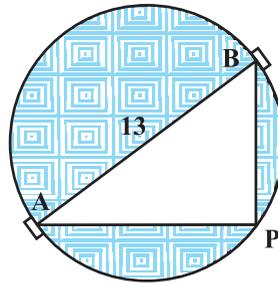


Fig. 4.4

Now,  $AB = 13\text{m}$ , and since  $AB$  is a diameter,

$$\angle APB = 90^\circ \quad (\text{Why?})$$

Therefore,  $AP^2 + PB^2 = AB^2$  (By Pythagoras theorem)

i.e.,  $(x + 7)^2 + x^2 = 13^2$

i.e.,  $x^2 + 14x + 49 + x^2 = 169$

i.e.,  $2x^2 + 14x - 120 = 0$

So, the distance 'x' of the pole from gate B satisfies the equation

$$x^2 + 7x - 60 = 0$$

So, it would be possible to place the pole if this equation has real roots. To see if this is so or not, let us consider its discriminant. The discriminant is

$$b^2 - 4ac = 7^2 - 4 \times 1 \times (-60) = 289 > 0.$$

So, the given quadratic equation has two real roots, and it is possible to erect the pole on the boundary of the park.

Solving the quadratic equation  $x^2 + 7x - 60 = 0$ , by the quadratic formula, we get

$$x = \frac{-7 \pm \sqrt{289}}{2} = \frac{-7 \pm 17}{2}$$

Therefore,  $x = 5$  or  $-12$ .

Since  $x$  is the distance between the pole and the gate B, it must be positive. Therefore,  $x = -12$  will have to be ignored. So,  $x = 5$ .

Thus, the pole has to be erected on the boundary of the park at a distance of 5m from the gate B and 12m from the gate A.

**Example 18 :** Find the discriminant of the equation  $3x^2 - 2x + \frac{1}{3} = 0$  and hence find the nature of its roots. Find them, if they are real.

**Solution :** Here  $a = 3$ ,  $b = -2$  and  $c = \frac{1}{3}$ .

Therefore, discriminant  $b^2 - 4ac = (-2)^2 - 4 \times 3 \times \frac{1}{3} = 4 - 4 = 0$ .

Hence, the given quadratic equation has two equal real roots.

The roots are  $\frac{-b}{2a}, \frac{-b}{2a}$ , i.e.,  $\frac{2}{6}, \frac{2}{6}$ , i.e.,  $\frac{1}{3}, \frac{1}{3}$ .

**EXERCISE 4.4**

- Find the nature of the roots of the following quadratic equations. If the real roots exist, find them:
  - $2x^2 - 3x + 5 = 0$
  - $3x^2 - 4\sqrt{3}x + 4 = 0$
  - $2x^2 - 6x + 3 = 0$
- Find the values of  $k$  for each of the following quadratic equations, so that they have two equal roots.
  - $2x^2 + kx + 3 = 0$
  - $kx(x - 2) + 6 = 0$
- Is it possible to design a rectangular mango grove whose length is twice its breadth, and the area is  $800 \text{ m}^2$ ? If so, find its length and breadth.
- Is the following situation possible? If so, determine their present ages.  
The sum of the ages of two friends is 20 years. Four years ago, the product of their ages in years was 48.
- Is it possible to design a rectangular park of perimeter 80 m and area  $400 \text{ m}^2$ ? If so, find its length and breadth.

**4.6 Summary**

In this chapter, you have studied the following points:

- A quadratic equation in the variable  $x$  is of the form  $ax^2 + bx + c = 0$ , where  $a, b, c$  are real numbers and  $a \neq 0$ .
- A real number  $\alpha$  is said to be a root of the quadratic equation  $ax^2 + bx + c = 0$ , if  $a\alpha^2 + b\alpha + c = 0$ . The zeroes of the quadratic polynomial  $ax^2 + bx + c$  and the roots of the quadratic equation  $ax^2 + bx + c = 0$  are the same.
- If we can factorise  $ax^2 + bx + c, a \neq 0$ , into a product of two linear factors, then the roots of the quadratic equation  $ax^2 + bx + c = 0$  can be found by equating each factor to zero.
- A quadratic equation can also be solved by the method of completing the square.
- Quadratic formula: The roots of a quadratic equation  $ax^2 + bx + c = 0$  are given by 
$$\frac{-b \pm \sqrt{b^2 - 4ac}}{2a}$$
, provided  $b^2 - 4ac \geq 0$ .
- A quadratic equation  $ax^2 + bx + c = 0$  has
  - two distinct real roots, if  $b^2 - 4ac > 0$ ,
  - two equal roots (i.e., coincident roots), if  $b^2 - 4ac = 0$ , and
  - no real roots, if  $b^2 - 4ac < 0$ .

### A NOTE TO THE READER

In case of word problems, the obtained solutions should always be verified with the conditions of the original problem and not in the equations formed (see Examples 11, 13, 19 of Chapter 3 and Examples 10, 11, 12 of Chapter 4).

© NCERT  
not to be republished



1062CH05

# ARITHMETIC PROGRESSIONS

# 5

## 5.1 Introduction

You must have observed that in nature, many things follow a certain pattern, such as the petals of a sunflower, the holes of a honeycomb, the grains on a maize cob, the spirals on a pineapple and on a pine cone etc.

We now look for some patterns which occur in our day-to-day life. Some such examples are :

- (i) Reena applied for a job and got selected. She has been offered a job with a starting monthly salary of ₹ 8000, with an annual increment of ₹ 500 in her salary. Her salary (in ₹) for the 1st, 2nd, 3rd, . . . years will be, respectively

8000, 8500, 9000, . . .

- (ii) The lengths of the rungs of a ladder decrease uniformly by 2 cm from bottom to top (see Fig. 5.1). The bottom rung is 45 cm in length. The lengths (in cm) of the 1st, 2nd, 3rd, . . . , 8th rung from the bottom to the top are, respectively

45, 43, 41, 39, 37, 35, 33, 31

- (iii) In a savings scheme, the amount becomes  $\frac{5}{4}$  times of itself after every 3 years. The maturity amount (in ₹) of an investment of ₹ 8000 after 3, 6, 9 and 12 years will be, respectively :

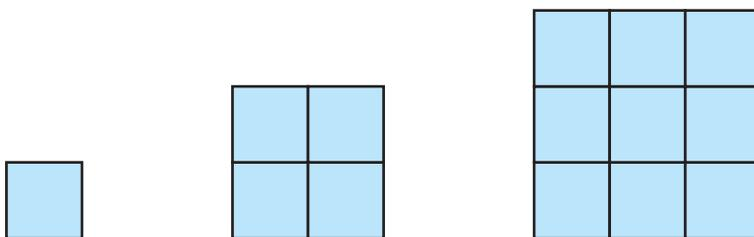
10000, 12500, 15625, 19531.25



Fig. 5.1

- (iv) The number of unit squares in squares with side 1, 2, 3, . . . units (see Fig. 5.2) are, respectively

$$1^2, 2^2, 3^2, \dots$$



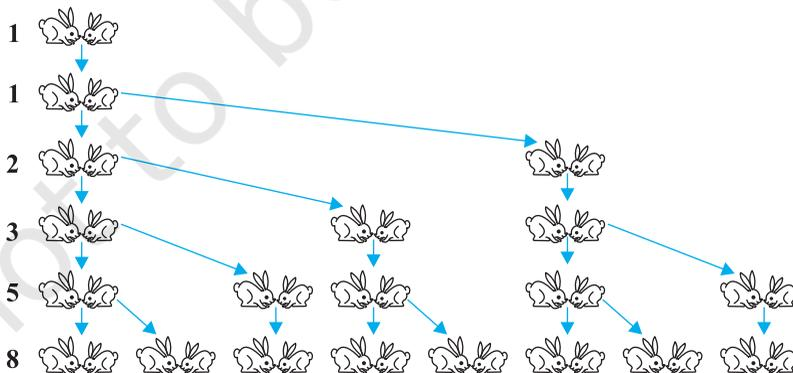
**Fig. 5.2**

- (v) Shakila puts ₹ 100 into her daughter's money box when she was one year old and increased the amount by ₹ 50 every year. The amounts of money (in ₹) in the box on the 1st, 2nd, 3rd, 4th, . . . birthday were

$$100, 150, 200, 250, \dots, \text{respectively.}$$

- (vi) A pair of rabbits are too young to produce in their first month. In the second, and every subsequent month, they produce a new pair. Each new pair of rabbits produce a new pair in their second month and in every subsequent month (see Fig. 5.3). Assuming no rabbit dies, the number of pairs of rabbits at the start of the 1st, 2nd, 3rd, . . . , 6th month, respectively are :

$$1, 1, 2, 3, 5, 8$$



**Fig. 5.3**

In the examples above, we observe some patterns. In some, we find that the succeeding terms are obtained by adding a fixed number, in other by multiplying with a fixed number, in another we find that they are squares of consecutive numbers, and so on.

In this chapter, we shall discuss one of these patterns in which succeeding terms are obtained by adding a fixed number to the preceding terms. We shall also see how to find their  $n$ th terms and the sum of  $n$  consecutive terms, and use this knowledge in solving some daily life problems.

## 5.2 Arithmetic Progressions

Consider the following lists of numbers :

- (i) 1, 2, 3, 4, ...
- (ii) 100, 70, 40, 10, ...
- (iii) -3, -2, -1, 0, ...
- (iv) 3, 3, 3, 3, ...
- (v) -1.0, -1.5, -2.0, -2.5, ...

Each of the numbers in the list is called a **term**.

Given a term, can you write the next term in each of the lists above? If so, how will you write it? Perhaps by following a pattern or rule. Let us observe and write the rule.

In (i), each term is 1 more than the term preceding it.

In (ii), each term is 30 less than the term preceding it.

In (iii), each term is obtained by adding 1 to the term preceding it.

In (iv), all the terms in the list are 3, i.e., each term is obtained by adding (or subtracting) 0 to the term preceding it.

In (v), each term is obtained by adding  $-0.5$  to (i.e., subtracting 0.5 from) the term preceding it.

In all the lists above, we see that successive terms are obtained by adding a fixed number to the preceding terms. Such list of numbers is said to form an **Arithmetic Progression ( AP )**.

**So, an arithmetic progression is a list of numbers in which each term is obtained by adding a fixed number to the preceding term except the first term.**

This fixed number is called the **common difference** of the AP. Remember that it can be positive, negative or zero.

Let us denote the first term of an AP by  $a_1$ , second term by  $a_2, \dots, n$ th term by  $a_n$  and the common difference by  $d$ . Then the AP becomes  $a_1, a_2, a_3, \dots, a_n$ .

So,  $a_2 - a_1 = a_3 - a_2 = \dots = a_n - a_{n-1} = d$ .

Some more examples of AP are:

- The heights ( in cm ) of some students of a school standing in a queue in the morning assembly are 147, 148, 149,  $\dots$ , 157.
- The minimum temperatures ( in degree celsius ) recorded for a week in the month of January in a city, arranged in ascending order are  
 $-3.1, -3.0, -2.9, -2.8, -2.7, -2.6, -2.5$
- The balance money ( in ₹ ) after paying 5 % of the total loan of ₹ 1000 every month is 950, 900, 850, 800,  $\dots$ , 50.
- The cash prizes ( in ₹ ) given by a school to the toppers of Classes I to XII are, respectively, 200, 250, 300, 350,  $\dots$ , 750.
- The total savings (in ₹) after every month for 10 months when ₹ 50 are saved each month are 50, 100, 150, 200, 250, 300, 350, 400, 450, 500.

It is left as an exercise for you to explain why each of the lists above is an AP.

You can see that

$$a, a + d, a + 2d, a + 3d, \dots$$

represents an arithmetic progression where  $a$  is the first term and  $d$  the common difference. This is called the **general form of an AP**.

Note that in examples (a) to (e) above, there are only a finite number of terms. Such an AP is called a **finite AP**. Also note that each of these Arithmetic Progressions (APs) has a last term. The APs in examples (i) to (v) in this section, are not finite APs and so they are called **infinite Arithmetic Progressions**. Such APs do not have a last term.

Now, to know about an AP, what is the minimum information that you need? Is it enough to know the first term? Or, is it enough to know only the common difference? You will find that you will need to know both – the first term  $a$  and the common difference  $d$ .

For instance if the first term  $a$  is 6 and the common difference  $d$  is 3, then the AP is

$$6, 9, 12, 15, \dots$$

and if  $a$  is 6 and  $d$  is  $-3$ , then the AP is

$$6, 3, 0, -3, \dots$$

Similarly, when

$$a = -7, \quad d = -2, \quad \text{the AP is } -7, -9, -11, -13, \dots$$

$$a = 1.0, \quad d = 0.1, \quad \text{the AP is } 1.0, 1.1, 1.2, 1.3, \dots$$

$$a = 0, \quad d = 1\frac{1}{2}, \quad \text{the AP is } 0, 1\frac{1}{2}, 3, 4\frac{1}{2}, 6, \dots$$

$$a = 2, \quad d = 0, \quad \text{the AP is } 2, 2, 2, 2, \dots$$

So, if you know what  $a$  and  $d$  are, you can list the AP. What about the other way round? That is, if you are given a list of numbers can you say that it is an AP and then find  $a$  and  $d$ ? Since  $a$  is the first term, it can easily be written. We know that in an AP, every succeeding term is obtained by adding  $d$  to the preceding term. So,  $d$  found by subtracting any term from its succeeding term, i.e., the term which immediately follows it should be same for an AP.

For example, for the list of numbers :

$$6, 9, 12, 15, \dots,$$

We have

$$a_2 - a_1 = 9 - 6 = 3,$$

$$a_3 - a_2 = 12 - 9 = 3,$$

$$a_4 - a_3 = 15 - 12 = 3$$

Here the difference of any two consecutive terms in each case is 3. So, the given list is an AP whose first term  $a$  is 6 and common difference  $d$  is 3.

For the list of numbers : 6, 3, 0, -3, ...

$$a_2 - a_1 = 3 - 6 = -3$$

$$a_3 - a_2 = 0 - 3 = -3$$

$$a_4 - a_3 = -3 - 0 = -3$$

Similarly this is also an AP whose first term is 6 and the common difference is -3.

In general, for an AP  $a_1, a_2, \dots, a_n$ , we have

$$d = a_{k+1} - a_k$$

where  $a_{k+1}$  and  $a_k$  are the  $(k + 1)$ th and the  $k$ th terms respectively.

To obtain  $d$  in a given AP, we need not find all of  $a_2 - a_1, a_3 - a_2, a_4 - a_3, \dots$ . It is enough to find only one of them.

Consider the list of numbers 1, 1, 2, 3, 5, ... By looking at it, you can tell that the difference between any two consecutive terms is not the same. So, this is not an AP.

Note that to find  $d$  in the AP : 6, 3, 0, -3, ... , we have subtracted 6 from 3 and not 3 from 6, i.e., we should subtract the  $k$ th term from the  $(k + 1)$  th term even if the  $(k + 1)$  th term is smaller.

Let us make the concept more clear through some examples.

**Example 1 :** For the AP :  $\frac{3}{2}, \frac{1}{2}, -\frac{1}{2}, -\frac{3}{2}, \dots$ , write the first term  $a$  and the common difference  $d$ .

**Solution :** Here,  $a = \frac{3}{2}, d = \frac{1}{2} - \frac{3}{2} = -1$ .

Remember that we can find  $d$  using any two consecutive terms, once we know that the numbers are in AP.

**Example 2 :** Which of the following list of numbers form an AP? If they form an AP, write the next two terms :

(i) 4, 10, 16, 22, ...

(ii) 1, -1, -3, -5, ...

(iii) -2, 2, -2, 2, -2, ...

(iv) 1, 1, 1, 2, 2, 2, 3, 3, 3, ...

**Solution :** (i) We have  $a_2 - a_1 = 10 - 4 = 6$   
 $a_3 - a_2 = 16 - 10 = 6$   
 $a_4 - a_3 = 22 - 16 = 6$

i.e.,  $a_{k+1} - a_k$  is the same every time.

So, the given list of numbers forms an AP with the common difference  $d = 6$ .

The next two terms are:  $22 + 6 = 28$  and  $28 + 6 = 34$ .

(ii)  $a_2 - a_1 = -1 - 1 = -2$

$a_3 - a_2 = -3 - (-1) = -3 + 1 = -2$

$a_4 - a_3 = -5 - (-3) = -5 + 3 = -2$

i.e.,  $a_{k+1} - a_k$  is the same every time.

So, the given list of numbers forms an AP with the common difference  $d = -2$ .

The next two terms are:

$-5 + (-2) = -7$  and  $-7 + (-2) = -9$

(iii)  $a_2 - a_1 = 2 - (-2) = 2 + 2 = 4$

$a_3 - a_2 = -2 - 2 = -4$

As  $a_2 - a_1 \neq a_3 - a_2$ , the given list of numbers does not form an AP.

$$\begin{aligned} \text{(iv) } a_2 - a_1 &= 1 - 1 = 0 \\ a_3 - a_2 &= 1 - 1 = 0 \\ a_4 - a_3 &= 2 - 1 = 1 \end{aligned}$$

Here,  $a_2 - a_1 = a_3 - a_2 \neq a_4 - a_3$ .

So, the given list of numbers does not form an AP.

### EXERCISE 5.1

- In which of the following situations, does the list of numbers involved make an arithmetic progression, and why?
  - The taxi fare after each km when the fare is ₹ 15 for the first km and ₹ 8 for each additional km.
  - The amount of air present in a cylinder when a vacuum pump removes  $\frac{1}{4}$  of the air remaining in the cylinder at a time.
  - The cost of digging a well after every metre of digging, when it costs ₹ 150 for the first metre and rises by ₹ 50 for each subsequent metre.
  - The amount of money in the account every year, when ₹ 10000 is deposited at compound interest at 8 % per annum.
- Write first four terms of the AP, when the first term  $a$  and the common difference  $d$  are given as follows:
  - $a = 10, \quad d = 10$
  - $a = -2, \quad d = 0$
  - $a = 4, \quad d = -3$
  - $a = -1, \quad d = \frac{1}{2}$
  - $a = -1.25, \quad d = -0.25$
- For the following APs, write the first term and the common difference:
  - 3, 1, -1, -3, ...
  - 5, -1, 3, 7, ...
  - $\frac{1}{3}, \frac{5}{3}, \frac{9}{3}, \frac{13}{3}, \dots$
  - 0.6, 1.7, 2.8, 3.9, ...
- Which of the following are APs ? If they form an AP, find the common difference  $d$  and write three more terms.
  - 2, 4, 8, 16, ...
  - $2, \frac{5}{2}, 3, \frac{7}{2}, \dots$
  - 1.2, -3.2, -5.2, -7.2, ...
  - 10, -6, -2, 2, ...
  - $3, 3 + \sqrt{2}, 3 + 2\sqrt{2}, 3 + 3\sqrt{2}, \dots$
  - 0.2, 0.22, 0.222, 0.2222, ...
  - 0, -4, -8, -12, ...
  - $-\frac{1}{2}, -\frac{1}{2}, -\frac{1}{2}, -\frac{1}{2}, \dots$

- |   |   |
|---|---|
| (ix) $1, 3, 9, 27, \dots$                               | (x) $a, 2a, 3a, 4a, \dots$                              |
| (xi) $a, a^2, a^3, a^4, \dots$                          | (xii) $\sqrt{2}, \sqrt{8}, \sqrt{18}, \sqrt{32}, \dots$ |
| (xiii) $\sqrt{3}, \sqrt{6}, \sqrt{9}, \sqrt{12}, \dots$ | (xiv) $1^2, 3^2, 5^2, 7^2, \dots$                       |
| (xv) $1^2, 5^2, 7^2, 73, \dots$                         |   |

### 5.3 $n$ th Term of an AP

Let us consider the situation again, given in Section 5.1 in which Reena applied for a job and got selected. She has been offered the job with a starting monthly salary of ₹ 8000, with an annual increment of ₹ 500. What would be her monthly salary for the fifth year?

To answer this, let us first see what her monthly salary for the second year would be.

It would be ₹  $(8000 + 500) = ₹ 8500$ . In the same way, we can find the monthly salary for the 3rd, 4th and 5th year by adding ₹ 500 to the salary of the previous year.

$$\begin{aligned}
 \text{So, the salary for the 3rd year} &= ₹ (8500 + 500) \\
 &= ₹ (8000 + 500 + 500) \\
 &= ₹ (8000 + 2 \times 500) \\
 &= ₹ [8000 + (3 - 1) \times 500] && \text{(for the 3rd year)} \\
 &= ₹ 9000
 \end{aligned}$$

$$\begin{aligned}
 \text{Salary for the 4th year} &= ₹ (9000 + 500) \\
 &= ₹ (8000 + 500 + 500 + 500) \\
 &= ₹ (8000 + 3 \times 500) \\
 &= ₹ [8000 + (4 - 1) \times 500] && \text{(for the 4th year)} \\
 &= ₹ 9500
 \end{aligned}$$

$$\begin{aligned}
 \text{Salary for the 5th year} &= ₹ (9500 + 500) \\
 &= ₹ (8000 + 500 + 500 + 500 + 500) \\
 &= ₹ (8000 + 4 \times 500) \\
 &= ₹ [8000 + (5 - 1) \times 500] && \text{(for the 5th year)} \\
 &= ₹ 10000
 \end{aligned}$$

Observe that we are getting a list of numbers

$$8000, 8500, 9000, 9500, 10000, \dots$$

These numbers are in AP. (Why?)

Now, looking at the pattern formed above, can you find her monthly salary for the 6th year? The 15th year? And, assuming that she will still be working in the job, what about the monthly salary for the 25th year? You would calculate this by adding ₹ 500 each time to the salary of the previous year to give the answer. Can we make this process shorter? Let us see. You may have already got some idea from the way we have obtained the salaries above.

Salary for the 15th year

$$\begin{aligned} &= \text{Salary for the 14th year} + ₹ 500 \\ &= ₹ \left[ 8000 + \underbrace{500 + 500 + 500 + \dots + 500}_{13 \text{ times}} \right] + ₹ 500 \\ &= ₹ [8000 + 14 \times 500] \\ &= ₹ [8000 + (15 - 1) \times 500] = ₹ 15000 \end{aligned}$$

i.e., First salary + (15 - 1) × Annual increment.

In the same way, her monthly salary for the 25th year would be

$$\begin{aligned} &₹ [8000 + (25 - 1) \times 500] = ₹ 20000 \\ &= \text{First salary} + (25 - 1) \times \text{Annual increment} \end{aligned}$$

This example would have given you some idea about how to write the 15th term, or the 25th term, and more generally, the  $n$ th term of the AP.

Let  $a_1, a_2, a_3, \dots$  be an AP whose first term  $a_1$  is  $a$  and the common difference is  $d$ .

Then,

$$\begin{aligned} \text{the second term } a_2 &= a + d = a + (2 - 1) d \\ \text{the third term } a_3 &= a_2 + d = (a + d) + d = a + 2d = a + (3 - 1) d \\ \text{the fourth term } a_4 &= a_3 + d = (a + 2d) + d = a + 3d = a + (4 - 1) d \\ &\dots\dots\dots \\ &\dots\dots\dots \end{aligned}$$

Looking at the pattern, we can say that the  $n$ th term  $a_n = a + (n - 1) d$ .

So, the  $n$ th term  $a_n$  of the AP with first term  $a$  and common difference  $d$  is given by  $a_n = a + (n - 1) d$ .

$a_n$  is also called the **general term of the AP**. If there are  $m$  terms in the AP, then  $a_m$  represents the **last term which is sometimes also denoted by  $l$** .

Let us consider some examples.

**Example 3 :** Find the 10th term of the AP : 2, 7, 12, . . .

**Solution :** Here,  $a = 2$ ,  $d = 7 - 2 = 5$  and  $n = 10$ .

We have  $a_n = a + (n - 1) d$

So,  $a_{10} = 2 + (10 - 1) \times 5 = 2 + 45 = 47$

Therefore, the 10th term of the given AP is 47.

**Example 4 :** Which term of the AP : 21, 18, 15, . . . is  $-81$ ? Also, is any term 0? Give reason for your answer.

**Solution :** Here,  $a = 21$ ,  $d = 18 - 21 = -3$  and  $a_n = -81$ , and we have to find  $n$ .

As  $a_n = a + (n - 1) d$ ,

we have  $-81 = 21 + (n - 1)(-3)$

$$-81 = 24 - 3n$$

$$-105 = -3n$$

So,  $n = 35$

Therefore, the 35th term of the given AP is  $-81$ .

Next, we want to know if there is any  $n$  for which  $a_n = 0$ . If such an  $n$  is there, then

$$21 + (n - 1)(-3) = 0,$$

i.e.,  $3(n - 1) = 21$

i.e.,  $n = 8$

So, the eighth term is 0.

**Example 5 :** Determine the AP whose 3rd term is 5 and the 7th term is 9.

**Solution :** We have

$$a_3 = a + (3 - 1) d = a + 2d = 5 \quad (1)$$

$$\text{and } a_7 = a + (7 - 1) d = a + 6d = 9 \quad (2)$$

Solving the pair of linear equations (1) and (2), we get

$$a = 3, \quad d = 1$$

Hence, the required AP is 3, 4, 5, 6, 7, . . .

**Example 6 :** Check whether 301 is a term of the list of numbers 5, 11, 17, 23, ...

**Solution :** We have :

$$a_2 - a_1 = 11 - 5 = 6, \quad a_3 - a_2 = 17 - 11 = 6, \quad a_4 - a_3 = 23 - 17 = 6$$

As  $a_{k+1} - a_k$  is the same for  $k = 1, 2, 3$ , etc., the given list of numbers is an AP.

Now,  $a = 5$  and  $d = 6$ .

Let 301 be a term, say, the  $n$ th term of this AP.

We know that

$$a_n = a + (n - 1) d$$

So,  $301 = 5 + (n - 1) \times 6$

i.e.,  $301 = 6n - 1$

So,  $n = \frac{302}{6} = \frac{151}{3}$

But  $n$  should be a positive integer (Why?). So, 301 is not a term of the given list of numbers.

**Example 7 :** How many two-digit numbers are divisible by 3?

**Solution :** The list of two-digit numbers divisible by 3 is :

$$12, 15, 18, \dots, 99$$

Is this an AP? Yes it is. Here,  $a = 12$ ,  $d = 3$ ,  $a_n = 99$ .

As  $a_n = a + (n - 1) d$ ,

we have  $99 = 12 + (n - 1) \times 3$

i.e.,  $87 = (n - 1) \times 3$

i.e.,  $n - 1 = \frac{87}{3} = 29$

i.e.,  $n = 29 + 1 = 30$

So, there are 30 two-digit numbers divisible by 3.

**Example 8 :** Find the 11th term from the last term (towards the first term) of the AP : 10, 7, 4, ..., -62.

**Solution :** Here,  $a = 10$ ,  $d = 7 - 10 = -3$ ,  $l = -62$ ,

where  $l = a + (n - 1) d$

To find the 11th term from the last term, we will find the total number of terms in the AP.

$$\text{So,} \quad -62 = 10 + (n - 1)(-3)$$

$$\text{i.e.,} \quad -72 = (n - 1)(-3)$$

$$\text{i.e.,} \quad n - 1 = 24$$

$$\text{or} \quad n = 25$$

So, there are 25 terms in the given AP.

The 11th term from the last term will be the 15th term. (Note that it will not be the 14th term. Why?)

$$\text{So,} \quad a_{15} = 10 + (15 - 1)(-3) = 10 - 42 = -32$$

i.e., the 11th term from the last term is  $-32$ .

#### Alternative Solution :

If we write the given AP in the reverse order, then  $a = -62$  and  $d = 3$  (Why?)

So, the question now becomes finding the 11th term with these  $a$  and  $d$ .

$$\text{So,} \quad a_{11} = -62 + (11 - 1) \times 3 = -62 + 30 = -32$$

So, the 11th term, which is now the required term, is  $-32$ .

**Example 9 :** A sum of ₹ 1000 is invested at 8% simple interest per year. Calculate the interest at the end of each year. Do these interests form an AP? If so, find the interest at the end of 30 years making use of this fact.

**Solution :** We know that the formula to calculate simple interest is given by

$$\text{Simple Interest} = \frac{P \times R \times T}{100}$$

$$\text{So, the interest at the end of the 1st year} = ₹ \frac{1000 \times 8 \times 1}{100} = ₹ 80$$

$$\text{The interest at the end of the 2nd year} = ₹ \frac{1000 \times 8 \times 2}{100} = ₹ 160$$

$$\text{The interest at the end of the 3rd year} = ₹ \frac{1000 \times 8 \times 3}{100} = ₹ 240$$

Similarly, we can obtain the interest at the end of the 4th year, 5th year, and so on.

So, the interest (in ₹) at the end of the 1st, 2nd, 3rd, . . . years, respectively are

$$80, 160, 240, \dots$$

It is an AP as the difference between the consecutive terms in the list is 80, i.e.,  $d = 80$ . Also,  $a = 80$ .

So, to find the interest at the end of 30 years, we shall find  $a_{30}$ .

Now, 
$$a_{30} = a + (30 - 1)d = 80 + 29 \times 80 = 2400$$

So, the interest at the end of 30 years will be ₹ 2400.

**Example 10 :** In a flower bed, there are 23 rose plants in the first row, 21 in the second, 19 in the third, and so on. There are 5 rose plants in the last row. How many rows are there in the flower bed?

**Solution :** The number of rose plants in the 1st, 2nd, 3rd, . . . , rows are :

$$23, 21, 19, \dots, 5$$

It forms an AP (Why?). Let the number of rows in the flower bed be  $n$ .

Then  $a = 23$ ,  $d = 21 - 23 = -2$ ,  $a_n = 5$

As, 
$$a_n = a + (n - 1)d$$

We have, 
$$5 = 23 + (n - 1)(-2)$$

i.e., 
$$-18 = (n - 1)(-2)$$

i.e., 
$$n = 10$$

So, there are 10 rows in the flower bed.

### EXERCISE 5.2

1. Fill in the blanks in the following table, given that  $a$  is the first term,  $d$  the common difference and  $a_n$  the  $n$ th term of the AP:

	$a$	$d$	$n$	$a_n$
(i)	7	3	8	...
(ii)	-18	...	10	0
(iii)	...	-3	18	-5
(iv)	-18.9	2.5	...	3.6
(v)	3.5	0	105	...

2. Choose the correct choice in the following and justify :

(i) 30th term of the AP: 10, 7, 4, ..., is

- (A) 97                      (B) 77                      (C) -77                      (D) -87

(ii) 11th term of the AP:  $-3, -\frac{1}{2}, 2, \dots$ , is

- (A) 28                      (B) 22                      (C) -38                      (D)  $-48\frac{1}{2}$

3. In the following APs, find the missing terms in the boxes :

(i) 2, , 26

(ii) , 13, , 3

(iii) 5, , ,  $9\frac{1}{2}$

(iv) -4, , , , , 6

(v) , 38, , , , -22

4. Which term of the AP : 3, 8, 13, 18, ..., is 78?

5. Find the number of terms in each of the following APs :

(i) 7, 13, 19, ..., 205

(ii)  $18, 15\frac{1}{2}, 13, \dots, -47$

6. Check whether -150 is a term of the AP : 11, 8, 5, 2 ...

7. Find the 31st term of an AP whose 11th term is 38 and the 16th term is 73.

8. An AP consists of 50 terms of which 3rd term is 12 and the last term is 106. Find the 29th term.

9. If the 3rd and the 9th terms of an AP are 4 and -8 respectively, which term of this AP is zero?

10. The 17th term of an AP exceeds its 10th term by 7. Find the common difference.

11. Which term of the AP : 3, 15, 27, 39, ... will be 132 more than its 54th term?

12. Two APs have the same common difference. The difference between their 100th terms is 100, what is the difference between their 1000th terms?

13. How many three-digit numbers are divisible by 7?

14. How many multiples of 4 lie between 10 and 250?

15. For what value of  $n$ , are the  $n$ th terms of two APs: 63, 65, 67, ... and 3, 10, 17, ... equal?

16. Determine the AP whose third term is 16 and the 7th term exceeds the 5th term by 12.

17. Find the 20th term from the last term of the AP : 3, 8, 13, . . . , 253.
18. The sum of the 4th and 8th terms of an AP is 24 and the sum of the 6th and 10th terms is 44. Find the first three terms of the AP.
19. Subba Rao started work in 1995 at an annual salary of ₹ 5000 and received an increment of ₹ 200 each year. In which year did his income reach ₹ 7000?
20. Ramkali saved ₹ 5 in the first week of a year and then increased her weekly savings by ₹ 1.75. If in the  $n$ th week, her weekly savings become ₹ 20.75, find  $n$ .

### 5.4 Sum of First $n$ Terms of an AP

Let us consider the situation again given in Section 5.1 in which Shakila put ₹ 100 into her daughter's money box when she was one year old, ₹ 150 on her second birthday, ₹ 200 on her third birthday and will continue in the same way. How much money will be collected in the money box by the time her daughter is 21 years old?



Here, the amount of money (in ₹) put in the money box on her first, second, third, fourth . . . birthday were respectively 100, 150, 200, 250, . . . till her 21st birthday. To find the total amount in the money box on her 21st birthday, we will have to write each of the 21 numbers in the list above and then add them up. Don't you think it would be a tedious and time consuming process? Can we make the process shorter? This would be possible if we can find a method for getting this sum. Let us see.

We consider the problem given to Gauss (about whom you read in Chapter 1), to solve when he was just 10 years old. He was asked to find the sum of the positive integers from 1 to 100. He immediately replied that the sum is 5050. Can you guess how did he do? He wrote :

$$S = 1 + 2 + 3 + \dots + 99 + 100$$

And then, reversed the numbers to write

$$S = 100 + 99 + \dots + 3 + 2 + 1$$

Adding these two, he got

$$\begin{aligned} 2S &= (100 + 1) + (99 + 2) + \dots + (3 + 98) + (2 + 99) + (1 + 100) \\ &= 101 + 101 + \dots + 101 + 101 \quad (100 \text{ times}) \end{aligned}$$

So, 
$$S = \frac{100 \times 101}{2} = 5050, \text{ i.e., the sum} = 5050.$$

We will now use the same technique to find the sum of the first  $n$  terms of an AP :

$$a, a + d, a + 2d, \dots$$

The  $n$ th term of this AP is  $a + (n - 1)d$ . Let  $S$  denote the sum of the first  $n$  terms of the AP. We have

$$S = a + (a + d) + (a + 2d) + \dots + [a + (n - 1)d] \quad (1)$$

Rewriting the terms in reverse order, we have

$$S = [a + (n - 1)d] + [a + (n - 2)d] + \dots + (a + d) + a \quad (2)$$

On adding (1) and (2), term-wise, we get

$$2S = \frac{[2a + (n - 1)d] + [2a + (n - 1)d] + \dots + [2a + (n - 1)d] + [2a + (n - 1)d]}{n \text{ times}}$$

$$\text{or, } 2S = n [2a + (n - 1)d] \quad (\text{Since, there are } n \text{ terms})$$

$$\text{or, } S = \frac{n}{2} [2a + (n - 1)d]$$

So, **the sum of the first  $n$  terms of an AP is given by**

$$S = \frac{n}{2} [2a + (n - 1)d]$$

$$\text{We can also write this as } S = \frac{n}{2} [a + a + (n - 1)d]$$

$$\text{i.e., } S = \frac{n}{2} (a + a_n) \quad (3)$$

Now, if there are only  $n$  terms in an AP, then  $a_n = l$ , the last term.  
From (3), we see that

$$S = \frac{n}{2} (a + l) \quad (4)$$

This form of the result is useful when the first and the last terms of an AP are given and the common difference is not given.

Now we return to the question that was posed to us in the beginning. The amount of money (in Rs) in the money box of Shakila's daughter on 1st, 2nd, 3rd, 4th birthday, . . . , were 100, 150, 200, 250, . . . , respectively.

This is an AP. We have to find the total money collected on her 21st birthday, i.e., the sum of the first 21 terms of this AP.

Here,  $a = 100$ ,  $d = 50$  and  $n = 21$ . Using the formula :

$$S = \frac{n}{2} [2a + (n-1)d],$$

we have 
$$S = \frac{21}{2} [2 \times 100 + (21-1) \times 50] = \frac{21}{2} [200 + 1000]$$

$$= \frac{21}{2} \times 1200 = 12600$$

So, the amount of money collected on her 21st birthday is ₹ 12600.

Hasn't the use of the formula made it much easier to solve the problem?

We also use  $S_n$  in place of  $S$  to denote the sum of first  $n$  terms of the AP. We write  $S_{20}$  to denote the sum of the first 20 terms of an AP. The formula for the sum of the first  $n$  terms involves four quantities  $S$ ,  $a$ ,  $d$  and  $n$ . If we know any three of them, we can find the fourth.

**Remark :** The  $n$ th term of an AP is the difference of the sum to first  $n$  terms and the sum to first  $(n-1)$  terms of it, i.e.,  $a_n = S_n - S_{n-1}$ .

Let us consider some examples.

**Example 11 :** Find the sum of the first 22 terms of the AP : 8, 3, -2, ...

**Solution :** Here,  $a = 8$ ,  $d = 3 - 8 = -5$ ,  $n = 22$ .

We know that

$$S = \frac{n}{2} [2a + (n-1)d]$$

Therefore, 
$$S = \frac{22}{2} [16 + 21(-5)] = 11(16 - 105) = 11(-89) = -979$$

So, the sum of the first 22 terms of the AP is -979.

**Example 12 :** If the sum of the first 14 terms of an AP is 1050 and its first term is 10, find the 20th term.

**Solution :** Here,  $S_{14} = 1050$ ,  $n = 14$ ,  $a = 10$ .

As 
$$S_n = \frac{n}{2} [2a + (n-1)d],$$

so, 
$$1050 = \frac{14}{2} [20 + 13d] = 140 + 91d$$

i.e.,  $910 = 91d$   
 or,  $d = 10$   
 Therefore,  $a_{20} = 10 + (20 - 1) \times 10 = 200$ , i.e. 20th term is 200.

**Example 13 :** How many terms of the AP : 24, 21, 18, ... must be taken so that their sum is 78?

**Solution :** Here,  $a = 24$ ,  $d = 21 - 24 = -3$ ,  $S_n = 78$ . We need to find  $n$ .

We know that  $S_n = \frac{n}{2}[2a + (n-1)d]$

So,  $78 = \frac{n}{2}[48 + (n-1)(-3)] = \frac{n}{2}[51 - 3n]$

or  $3n^2 - 51n + 156 = 0$

or  $n^2 - 17n + 52 = 0$

or  $(n - 4)(n - 13) = 0$

or  $n = 4$  or  $13$

Both values of  $n$  are admissible. So, the number of terms is either 4 or 13.

**Remarks :**

1. In this case, the sum of the first 4 terms = the sum of the first 13 terms = 78.
2. Two answers are possible because the sum of the terms from 5th to 13th will be zero. This is because  $a$  is positive and  $d$  is negative, so that some terms will be positive and some others negative, and will cancel out each other.

**Example 14 :** Find the sum of :

- (i) the first 1000 positive integers    (ii) the first  $n$  positive integers

**Solution :**

(i) Let  $S = 1 + 2 + 3 + \dots + 1000$

Using the formula  $S_n = \frac{n}{2}(a+l)$  for the sum of the first  $n$  terms of an AP, we have

$$S_{1000} = \frac{1000}{2}(1 + 1000) = 500 \times 1001 = 500500$$

So, the sum of the first 1000 positive integers is 500500.

(ii) Let  $S_n = 1 + 2 + 3 + \dots + n$

Here  $a = 1$  and the last term  $l$  is  $n$ .

Therefore,  $S_n = \frac{n(1+n)}{2}$  or  $S_n = \frac{n(n+1)}{2}$

So, the sum of first  $n$  positive integers is given by

$$S_n = \frac{n(n+1)}{2}$$

**Example 15 :** Find the sum of first 24 terms of the list of numbers whose  $n$ th term is given by

$$a_n = 3 + 2n$$

**Solution :**

As

$$a_n = 3 + 2n,$$

so,

$$a_1 = 3 + 2 = 5$$

$$a_2 = 3 + 2 \times 2 = 7$$

$$a_3 = 3 + 2 \times 3 = 9$$

$\vdots$

List of numbers becomes 5, 7, 9, 11, ...

Here,

$$7 - 5 = 9 - 7 = 11 - 9 = 2 \text{ and so on.}$$

So, it forms an AP with common difference  $d = 2$ .

To find  $S_{24}$ , we have  $n = 24$ ,  $a = 5$ ,  $d = 2$ .

Therefore,  $S_{24} = \frac{24}{2} [2 \times 5 + (24 - 1) \times 2] = 12 [10 + 46] = 672$

So, sum of first 24 terms of the list of numbers is 672.

**Example 16 :** A manufacturer of TV sets produced 600 sets in the third year and 700 sets in the seventh year. Assuming that the production increases uniformly by a fixed number every year, find :

- (i) the production in the 1st year                      (ii) the production in the 10th year  
(iii) the total production in first 7 years

**Solution :** (i) Since the production increases uniformly by a fixed number every year, the number of TV sets manufactured in 1st, 2nd, 3rd, . . . , years will form an AP.

Let us denote the number of TV sets manufactured in the  $n$ th year by  $a_n$ .

Then,  $a_3 = 600$  and  $a_7 = 700$

or,  $a + 2d = 600$

and  $a + 6d = 700$

Solving these equations, we get  $d = 25$  and  $a = 550$ .

Therefore, production of TV sets in the first year is 550.

(ii) Now  $a_{10} = a + 9d = 550 + 9 \times 25 = 775$

So, production of TV sets in the 10th year is 775.

(iii) Also,

$$S_7 = \frac{7}{2} [2 \times 550 + (7 - 1) \times 25]$$

$$= \frac{7}{2} [1100 + 150] = 4375$$

Thus, the total production of TV sets in first 7 years is 4375.

### EXERCISE 5.3

1. Find the sum of the following APs:

(i) 2, 7, 12, ..., to 10 terms.

(ii) -37, -33, -29, ..., to 12 terms.

(iii) 0.6, 1.7, 2.8, ..., to 100 terms.

(iv)  $\frac{1}{15}, \frac{1}{12}, \frac{1}{10}, \dots$ , to 11 terms.

2. Find the sums given below :

(i)  $7 + 10\frac{1}{2} + 14 + \dots + 84$

(ii)  $34 + 32 + 30 + \dots + 10$

(iii)  $-5 + (-8) + (-11) + \dots + (-230)$

3. In an AP:

(i) given  $a = 5, d = 3, a_n = 50$ , find  $n$  and  $S_n$ .

(ii) given  $a = 7, a_{13} = 35$ , find  $d$  and  $S_{13}$ .

(iii) given  $a_{12} = 37, d = 3$ , find  $a$  and  $S_{12}$ .

(iv) given  $a_3 = 15, S_{10} = 125$ , find  $d$  and  $a_{10}$ .

(v) given  $d = 5, S_9 = 75$ , find  $a$  and  $a_9$ .

(vi) given  $a = 2, d = 8, S_n = 90$ , find  $n$  and  $a_n$ .

(vii) given  $a = 8, a_n = 62, S_n = 210$ , find  $n$  and  $d$ .

(viii) given  $a_n = 4, d = 2, S_n = -14$ , find  $n$  and  $a$ .

(ix) given  $a = 3, n = 8, S = 192$ , find  $d$ .

(x) given  $l = 28, S = 144$ , and there are total 9 terms. Find  $a$ .

4. How many terms of the AP : 9, 17, 25, . . . must be taken to give a sum of 636?
5. The first term of an AP is 5, the last term is 45 and the sum is 400. Find the number of terms and the common difference.
6. The first and the last terms of an AP are 17 and 350 respectively. If the common difference is 9, how many terms are there and what is their sum?
7. Find the sum of first 22 terms of an AP in which  $d = 7$  and 22nd term is 149.
8. Find the sum of first 51 terms of an AP whose second and third terms are 14 and 18 respectively.
9. If the sum of first 7 terms of an AP is 49 and that of 17 terms is 289, find the sum of first  $n$  terms.
10. Show that  $a_1, a_2, \dots, a_n, \dots$  form an AP where  $a_n$  is defined as below :

$$(i) a_n = 3 + 4n$$

$$(ii) a_n = 9 - 5n$$

Also find the sum of the first 15 terms in each case.

11. If the sum of the first  $n$  terms of an AP is  $4n - n^2$ , what is the first term (that is  $S_1$ )? What is the sum of first two terms? What is the second term? Similarly, find the 3rd, the 10th and the  $n$ th terms.
12. Find the sum of the first 40 positive integers divisible by 6.
13. Find the sum of the first 15 multiples of 8.
14. Find the sum of the odd numbers between 0 and 50.
15. A contract on construction job specifies a penalty for delay of completion beyond a certain date as follows: ₹ 200 for the first day, ₹ 250 for the second day, ₹ 300 for the third day, etc., the penalty for each succeeding day being ₹ 50 more than for the preceding day. How much money the contractor has to pay as penalty, if he has delayed the work by 30 days?
16. A sum of ₹ 700 is to be used to give seven cash prizes to students of a school for their overall academic performance. If each prize is ₹ 20 less than its preceding prize, find the value of each of the prizes.
17. In a school, students thought of planting trees in and around the school to reduce air pollution. It was decided that the number of trees, that each section of each class will plant, will be the same as the class, in which they are studying, e.g., a section of Class I will plant 1 tree, a section of Class II will plant 2 trees and so on till Class XII. There are three sections of each class. How many trees will be planted by the students?
18. A spiral is made up of successive semicircles, with centres alternately at A and B, starting with centre at A, of radii 0.5 cm, 1.0 cm, 1.5 cm, 2.0 cm, . . . as shown in Fig. 5.4. What is the total length of such a spiral made up of thirteen consecutive semicircles? (Take  $\pi = \frac{22}{7}$ )

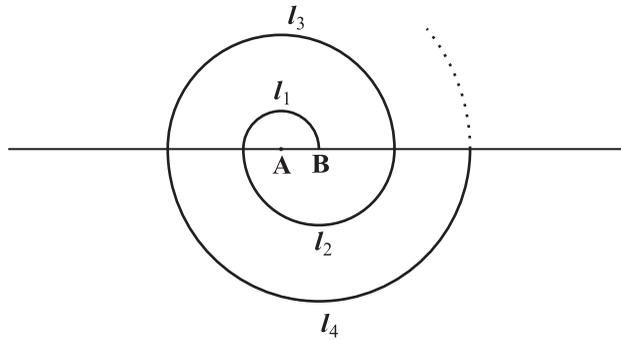


Fig. 5.4

[Hint : Length of successive semicircles is  $l_1, l_2, l_3, l_4, \dots$  with centres at A, B, A, B,  $\dots$ , respectively.]

19. 200 logs are stacked in the following manner: 20 logs in the bottom row, 19 in the next row, 18 in the row next to it and so on (see Fig. 5.5). In how many rows are the 200 logs placed and how many logs are in the top row?

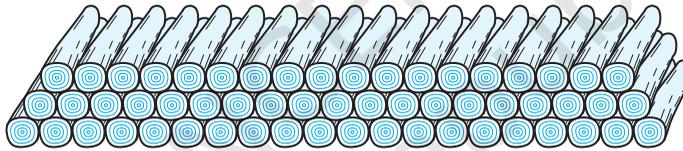


Fig. 5.5

20. In a potato race, a bucket is placed at the starting point, which is 5 m from the first potato, and the other potatoes are placed 3 m apart in a straight line. There are ten potatoes in the line (see Fig. 5.6).

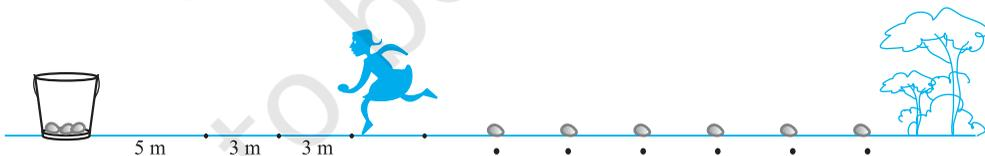


Fig. 5.6

A competitor starts from the bucket, picks up the nearest potato, runs back with it, drops it in the bucket, runs back to pick up the next potato, runs to the bucket to drop it in, and she continues in the same way until all the potatoes are in the bucket. What is the total distance the competitor has to run?

[Hint : To pick up the first potato and the second potato, the total distance (in metres) run by a competitor is  $2 \times 5 + 2 \times (5 + 3)$ ]

**EXERCISE 5.4 (Optional)\***

1. Which term of the AP: 121, 117, 113, ..., is its first negative term?

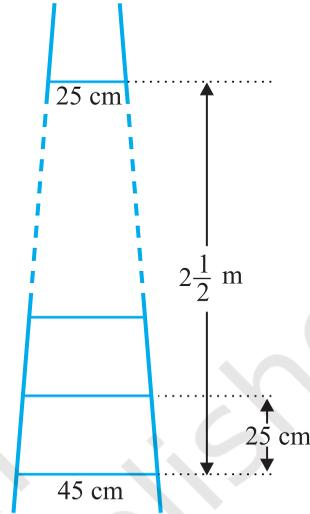
[Hint : Find  $n$  for  $a_n < 0$ ]

2. The sum of the third and the seventh terms of an AP is 6 and their product is 8. Find the sum of first sixteen terms of the AP.

3. A ladder has rungs 25 cm apart. (see Fig. 5.7). The rungs decrease uniformly in length from 45 cm at the bottom to 25 cm at the top. If the top and

the bottom rungs are  $2\frac{1}{2}$  m apart, what is the length of the wood required for the rungs?

[Hint : Number of rungs =  $\frac{250}{25} + 1$ ]



**Fig. 5.7**

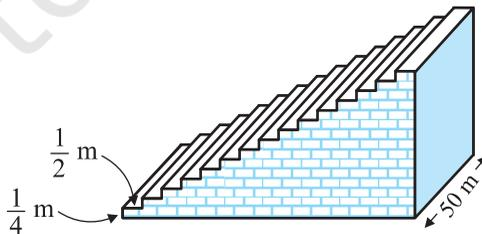
4. The houses of a row are numbered consecutively from 1 to 49. Show that there is a value of  $x$  such that the sum of the numbers of the houses preceding the house numbered  $x$  is equal to the sum of the numbers of the houses following it. Find this value of  $x$ .

[Hint :  $S_{x-1} = S_{49} - S_x$ ]

5. A small terrace at a football ground comprises of 15 steps each of which is 50 m long and built of solid concrete.

Each step has a rise of  $\frac{1}{4}$  m and a tread of  $\frac{1}{2}$  m. (see Fig. 5.8). Calculate the total volume of concrete required to build the terrace.

[Hint : Volume of concrete required to build the first step =  $\frac{1}{4} \times \frac{1}{2} \times 50 \text{ m}^3$ ]



**Fig. 5.8**

\* These exercises are not from the examination point of view.

## 5.5 Summary

In this chapter, you have studied the following points :

1. An **arithmetic progression** (AP) is a list of numbers in which each term is obtained by adding a fixed number  $d$  to the preceding term, except the first term. The fixed number  $d$  is called the **common difference**.

The general form of an AP is  $a, a + d, a + 2d, a + 3d, \dots$

2. A given list of numbers  $a_1, a_2, a_3, \dots$  is an AP, if the differences  $a_2 - a_1, a_3 - a_2, a_4 - a_3, \dots$ , give the same value, i.e., if  $a_{k+1} - a_k$  is the same for different values of  $k$ .
3. In an AP with first term  $a$  and common difference  $d$ , the  $n$ th term (or the general term) is given by  $a_n = a + (n - 1)d$ .
4. The sum of the first  $n$  terms of an AP is given by :

$$S = \frac{n}{2}[2a + (n - 1)d]$$

5. If  $l$  is the last term of the finite AP, say the  $n$ th term, then the sum of all terms of the AP is given by :

$$S = \frac{n}{2}(a + l)$$

### A NOTE TO THE READER

If  $a, b, c$  are in AP, then  $b = \frac{a + c}{2}$  and  $b$  is called the arithmetic mean of  $a$  and  $c$ .



1062CH06

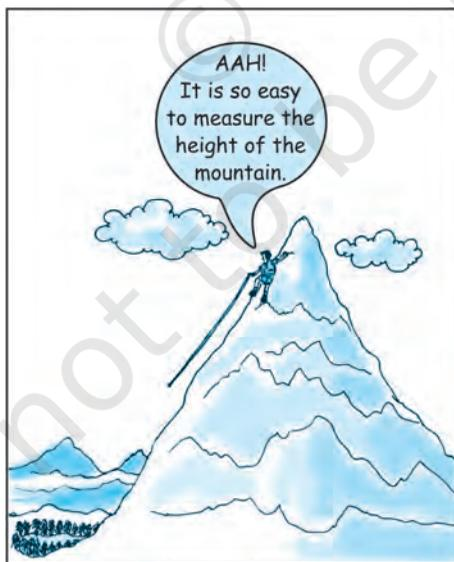
# TRIANGLES

# 6

## 6.1 Introduction

You are familiar with triangles and many of their properties from your earlier classes. In Class IX, you have studied congruence of triangles in detail. Recall that two figures are said to be *congruent*, if they have the same shape and the same size. In this chapter, we shall study about those figures which have the same shape but not necessarily the same size. Two figures having the same shape (and not necessarily the same size) are called *similar figures*. In particular, we shall discuss the similarity of triangles and apply this knowledge in giving a simple proof of Pythagoras Theorem learnt earlier.

Can you guess how heights of mountains (say Mount Everest) or distances of some long distant objects (say moon) have been found out? Do you think these have



been measured directly with the help of a measuring tape? In fact, all these heights and distances have been found out using the idea of indirect measurements, which is based on the principle of similarity of figures (see Example 7, Q.15 of Exercise 6.3 and also Chapters 8 and 9 of this book).

## 6.2 Similar Figures

In Class IX, you have seen that all circles with the same radii are congruent, all squares with the same side lengths are congruent and all equilateral triangles with the same side lengths are congruent.

Now consider any two (or more) circles [see Fig. 6.1 (i)]. Are they congruent? Since all of them do not have the same radius, they are not congruent to each other. Note that some are congruent and some are not, but all of them have the same shape. So they all are, what we call, *similar*. Two similar figures have the same shape but not necessarily the same size. Therefore, all circles are similar. What about two (or more) squares or two (or more) equilateral triangles [see Fig. 6.1 (ii) and (iii)]? As observed in the case of circles, here also all squares are similar and all equilateral triangles are similar.

From the above, we can say *that all congruent figures are similar but the similar figures need not be congruent*.

Can a circle and a square be similar? Can a triangle and a square be similar? These questions can be answered by just looking at the figures (see Fig. 6.1). Evidently these figures are not similar. (Why?)

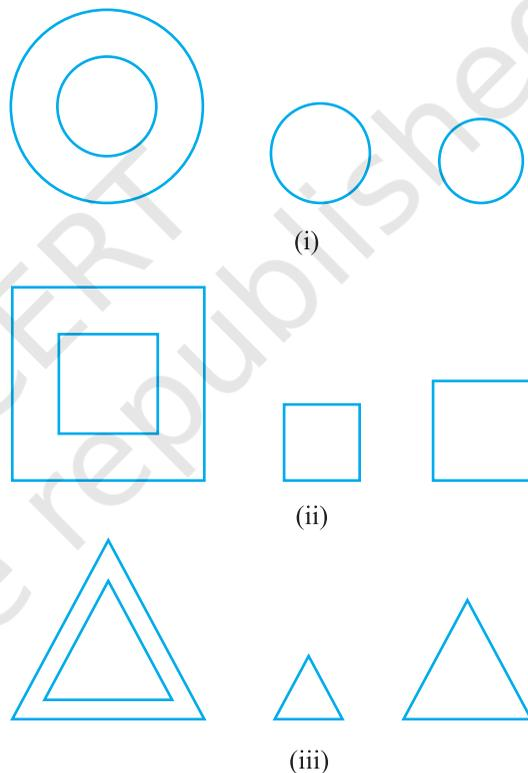


Fig. 6.1

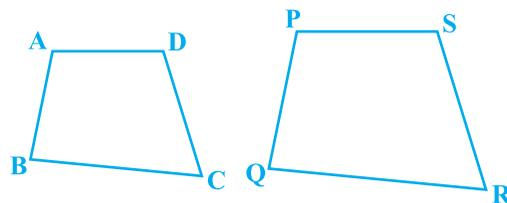
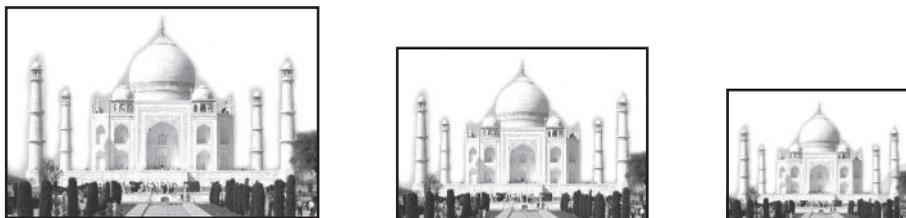


Fig. 6.2

What can you say about the two quadrilaterals ABCD and PQRS (see Fig 6.2)? Are they similar? These figures appear to be similar but we cannot be certain about it. Therefore, we must have some definition of similarity of figures and based on this definition some rules to decide whether the two given figures are similar or not. For this, let us look at the photographs given in Fig. 6.3:



**Fig. 6.3**

You will at once say that they are the photographs of the same monument (Taj Mahal) but are in different sizes. Would you say that the three photographs are similar? Yes, they are.

What can you say about the two photographs of the same size of the same person one at the age of 10 years and the other at the age of 40 years? Are these photographs similar? These photographs are of the same size but certainly they are not of the same shape. So, they are not similar.

What does the photographer do when she prints photographs of different sizes from the same negative? You must have heard about the stamp size, passport size and postcard size photographs. She generally takes a photograph on a small size film, say of 35mm size and then enlarges it into a bigger size, say 45mm (or 55mm). Thus, if we consider any line segment in the smaller photograph (figure), its corresponding line

segment in the bigger photograph (figure) will be  $\frac{45}{35}$  (or  $\frac{55}{35}$ ) of that of the line segment.

This really means that every line segment of the smaller photograph is enlarged (increased) *in the ratio* 35:45 (or 35:55). It can also be said that every line segment of the bigger photograph is reduced (decreased) in the ratio 45:35 (or 55:35). Further, if you consider inclinations (or angles) between any pair of corresponding line segments in the two photographs of different sizes, you shall see that these inclinations (or angles) *are always equal*. This is the essence of the similarity of two figures and in particular of two polygons. We say that:

*Two polygons of the same number of sides are similar, if (i) their corresponding angles are equal and (ii) their corresponding sides are in the same ratio (or proportion).*

Note that the same ratio of the corresponding sides is referred to as *the scale factor* (or the *Representative Fraction*) for the polygons. You must have heard that world maps (i.e., global maps) and blue prints for the construction of a building are prepared using a suitable scale factor and observing certain conventions.

In order to understand similarity of figures more clearly, let us perform the following activity:

**Activity 1 :** Place a lighted bulb at a point O on the ceiling and directly below it a table in your classroom. Let us cut a polygon, say a quadrilateral ABCD, from a plane cardboard and place this cardboard parallel to the ground between the lighted bulb and the table. Then a shadow of ABCD is cast on the table. Mark the outline of this shadow as A'B'C'D' (see Fig.6.4).

Note that the quadrilateral A'B'C'D' is an enlargement (or magnification) of the quadrilateral ABCD. This is because of the property of light that light propagates in a straight line. You may also note that A' lies on ray OA, B' lies on ray OB, C' lies on ray OC and D' lies on ray OD. Thus, quadrilaterals A'B'C'D' and ABCD are of the same shape but of different sizes.

So, quadrilateral A'B'C'D' is similar to quadrilateral ABCD. We can also say that quadrilateral ABCD is similar to the quadrilateral A'B'C'D'.

Here, you can also note that vertex A' corresponds to vertex A, vertex B' corresponds to vertex B, vertex C' corresponds to vertex C and vertex D' corresponds to vertex D. Symbolically, these correspondences are represented as  $A' \leftrightarrow A$ ,  $B' \leftrightarrow B$ ,  $C' \leftrightarrow C$  and  $D' \leftrightarrow D$ . By actually measuring the angles and the sides of the two quadrilaterals, you may verify that

$$(i) \angle A = \angle A', \angle B = \angle B', \angle C = \angle C', \angle D = \angle D' \text{ and}$$

$$(ii) \frac{AB}{A'B'} = \frac{BC}{B'C'} = \frac{CD}{C'D'} = \frac{DA}{D'A'}.$$

This again emphasises that *two polygons of the same number of sides are similar, if (i) all the corresponding angles are equal and (ii) all the corresponding sides are in the same ratio (or proportion).*

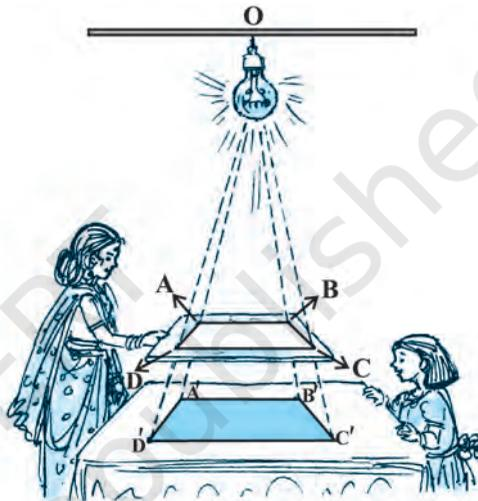


Fig. 6.4

From the above, you can easily say that quadrilaterals ABCD and PQRS of Fig. 6.5 are similar.

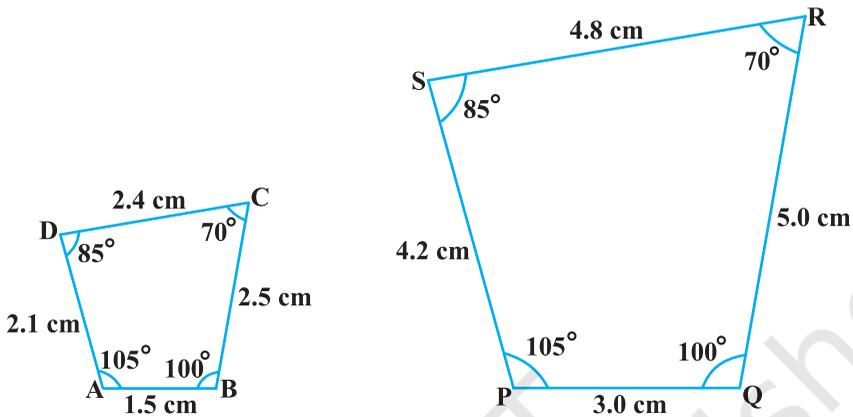


Fig. 6.5

**Remark :** You can verify that if one polygon is similar to another polygon and this second polygon is similar to a third polygon, then the first polygon is similar to the third polygon.

You may note that in the two quadrilaterals (a square and a rectangle) of Fig. 6.6, corresponding angles are equal, but their corresponding sides are not in the same ratio.

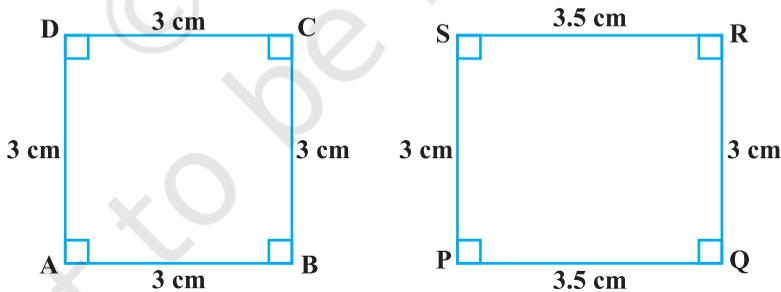


Fig. 6.6

So, the two quadrilaterals are not similar. Similarly, you may note that in the two quadrilaterals (a square and a rhombus) of Fig. 6.7, corresponding sides are in the same ratio, but their corresponding angles are not equal. Again, the two polygons (quadrilaterals) are not similar.

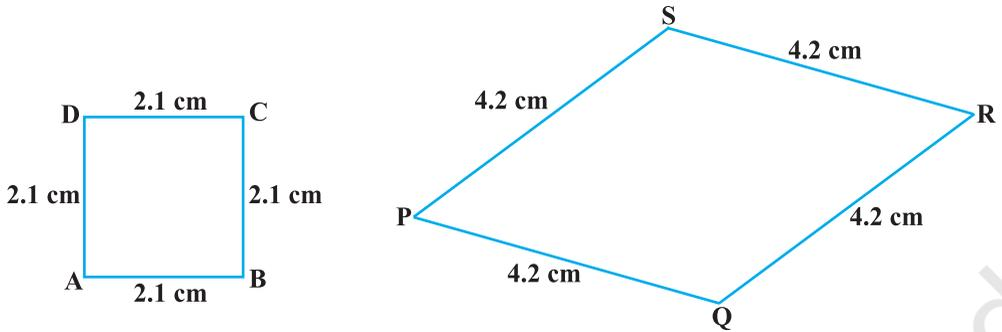


Fig. 6.7

Thus, either of the above two conditions (i) and (ii) of similarity of two polygons is not sufficient for them to be similar.

### EXERCISE 6.1

- Fill in the blanks using the correct word given in brackets :
  - All circles are \_\_\_\_\_. (congruent, similar)
  - All squares are \_\_\_\_\_. (similar, congruent)
  - All \_\_\_\_\_ triangles are similar. (isosceles, equilateral)
  - Two polygons of the same number of sides are similar, if (a) their corresponding angles are \_\_\_\_\_ and (b) their corresponding sides are \_\_\_\_\_. (equal, proportional)
- Give two different examples of pair of
  - similar figures.
  - non-similar figures.
- State whether the following quadrilaterals are similar or not:

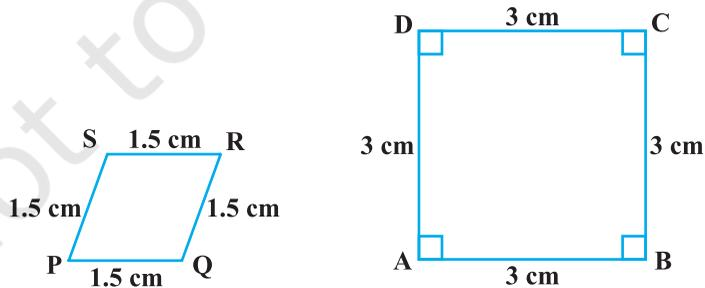


Fig. 6.8

### 6.3 Similarity of Triangles

What can you say about the similarity of two triangles?

You may recall that triangle is also a polygon. So, we can state the same conditions for the similarity of two triangles. That is:

*Two triangles are similar, if*

- (i) *their corresponding angles are equal and*
- (ii) *their corresponding sides are in the same ratio (or proportion).*

Note that if corresponding angles of two triangles are equal, then they are known as *equiangular triangles*. A famous Greek mathematician Thales gave an important truth relating to two equiangular triangles which is as follows:

*The ratio of any two corresponding sides in two equiangular triangles is always the same.*

It is believed that he had used a result called the *Basic Proportionality Theorem* (now known as the *Thales Theorem*) for the same.

To understand the Basic Proportionality Theorem, let us perform the following activity:

**Activity 2 :** Draw any angle XAY and on its one arm AX, mark points (say five points) P, Q, D, R and B such that  $AP = PQ = QD = DR = RB$ .

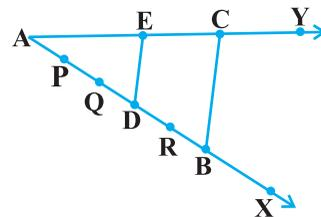
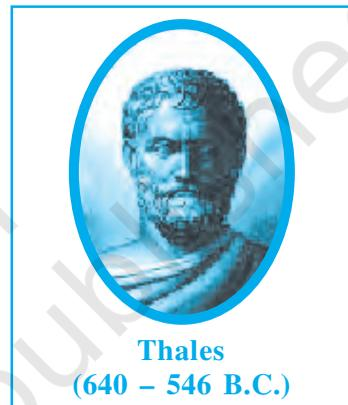
Now, through B, draw any line intersecting arm AY at C (see Fig. 6.9).

Also, through the point D, draw a line parallel to BC to intersect AC at E. Do you observe from

your constructions that  $\frac{AD}{DB} = \frac{3}{2}$ ? Measure AE and

EC. What about  $\frac{AE}{EC}$ ? Observe that  $\frac{AE}{EC}$  is also equal to  $\frac{3}{2}$ . Thus, you can see that

in  $\Delta ABC$ ,  $DE \parallel BC$  and  $\frac{AD}{DB} = \frac{AE}{EC}$ . Is it a coincidence? No, it is due to the following theorem (known as the Basic Proportionality Theorem):



**Fig. 6.9**

**Theorem 6.1 :** *If a line is drawn parallel to one side of a triangle to intersect the other two sides in distinct points, the other two sides are divided in the same ratio.*

**Proof :** We are given a triangle ABC in which a line parallel to side BC intersects other two sides AB and AC at D and E respectively (see Fig. 6.10).

We need to prove that  $\frac{AD}{DB} = \frac{AE}{EC}$ .

Let us join BE and CD and then draw  $DM \perp AC$  and  $EN \perp AB$ .

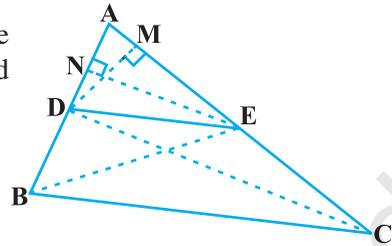


Fig. 6.10

Now, area of  $\triangle ADE$  ( $= \frac{1}{2}$  base  $\times$  height)  $= \frac{1}{2}$  AD  $\times$  EN.

Recall from Class IX, that area of  $\triangle ADE$  is denoted as  $\text{ar}(\triangle ADE)$ .

So, 
$$\text{ar}(\triangle ADE) = \frac{1}{2} \text{AD} \times \text{EN}$$

Similarly, 
$$\text{ar}(\triangle BDE) = \frac{1}{2} \text{DB} \times \text{EN},$$

$$\text{ar}(\triangle ADE) = \frac{1}{2} \text{AE} \times \text{DM} \quad \text{and} \quad \text{ar}(\triangle DEC) = \frac{1}{2} \text{EC} \times \text{DM}.$$

Therefore, 
$$\frac{\text{ar}(\triangle ADE)}{\text{ar}(\triangle BDE)} = \frac{\frac{1}{2} \text{AD} \times \text{EN}}{\frac{1}{2} \text{DB} \times \text{EN}} = \frac{\text{AD}}{\text{DB}} \quad (1)$$

and 
$$\frac{\text{ar}(\triangle ADE)}{\text{ar}(\triangle DEC)} = \frac{\frac{1}{2} \text{AE} \times \text{DM}}{\frac{1}{2} \text{EC} \times \text{DM}} = \frac{\text{AE}}{\text{EC}} \quad (2)$$

Note that  $\triangle BDE$  and  $\triangle DEC$  are on the same base DE and between the same parallels BC and DE.

So, 
$$\text{ar}(\triangle BDE) = \text{ar}(\triangle DEC) \quad (3)$$

Therefore, from (1), (2) and (3), we have :

$$\frac{AD}{DB} = \frac{AE}{EC}$$

Is the converse of this theorem also true (For the meaning of converse, see Appendix 1)? To examine this, let us perform the following activity:

**Activity 3 :** Draw an angle XAY on your notebook and on ray AX, mark points  $B_1, B_2, B_3, B_4$  and B such that  $AB_1 = B_1B_2 = B_2B_3 = B_3B_4 = B_4B$ .

Similarly, on ray AY, mark points  $C_1, C_2, C_3, C_4$  and C such that  $AC_1 = C_1C_2 = C_2C_3 = C_3C_4 = C_4C$ . Then join  $B_1C_1$  and BC (see Fig. 6.11).

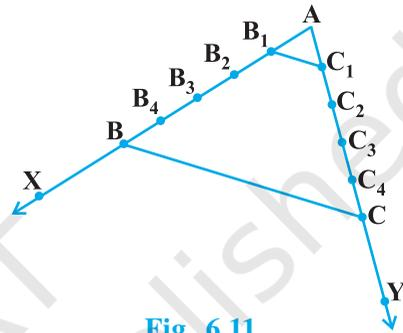


Fig. 6.11

Note that  $\frac{AB_1}{B_1B} = \frac{AC_1}{C_1C}$  (Each equal to  $\frac{1}{4}$ )

You can also see that lines  $B_1C_1$  and BC are parallel to each other, i.e.,

$$B_1C_1 \parallel BC \quad (1)$$

Similarly, by joining  $B_2C_2, B_3C_3$  and  $B_4C_4$ , you can see that:

$$\frac{AB_2}{B_2B} = \frac{AC_2}{C_2C} \left( = \frac{2}{3} \right) \text{ and } B_2C_2 \parallel BC \quad (2)$$

$$\frac{AB_3}{B_3B} = \frac{AC_3}{C_3C} \left( = \frac{3}{2} \right) \text{ and } B_3C_3 \parallel BC \quad (3)$$

$$\frac{AB_4}{B_4B} = \frac{AC_4}{C_4C} \left( = \frac{4}{1} \right) \text{ and } B_4C_4 \parallel BC \quad (4)$$

From (1), (2), (3) and (4), it can be observed that if a line divides two sides of a triangle in the same ratio, then the line is parallel to the third side.

You can repeat this activity by drawing any angle XAY of different measure and taking any number of equal parts on arms AX and AY. Each time, you will arrive at the same result. Thus, we obtain the following theorem, which is the converse of Theorem 6.1:

**Theorem 6.2 :** *If a line divides any two sides of a triangle in the same ratio, then the line is parallel to the third side.*

This theorem can be proved by taking a line DE such

that  $\frac{AD}{DB} = \frac{AE}{EC}$  and assuming that DE is not parallel to BC (see Fig. 6.12).

If DE is not parallel to BC, draw a line DE' parallel to BC.

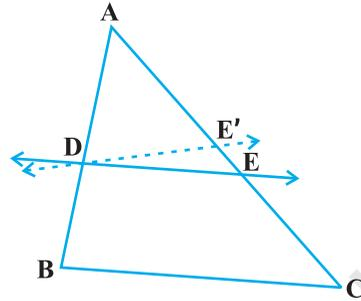


Fig. 6.12

So,  $\frac{AD}{DB} = \frac{AE'}{E'C}$  (Why ?)

Therefore,  $\frac{AE}{EC} = \frac{AE'}{E'C}$  (Why ?)

Adding 1 to both sides of above, you can see that E and E' must coincide. (Why ?)

Let us take some examples to illustrate the use of the above theorems.

**Example 1 :** If a line intersects sides AB and AC of a  $\Delta ABC$  at D and E respectively and is parallel to BC, prove that  $\frac{AD}{AB} = \frac{AE}{AC}$  (see Fig. 6.13).

**Solution :**  $DE \parallel BC$  (Given)

So,  $\frac{AD}{DB} = \frac{AE}{EC}$  (Theorem 6.1)

or,  $\frac{DB}{AD} = \frac{EC}{AE}$

or,  $\frac{DB}{AD} + 1 = \frac{EC}{AE} + 1$

or,  $\frac{AB}{AD} = \frac{AC}{AE}$

So,  $\frac{AD}{AB} = \frac{AE}{AC}$

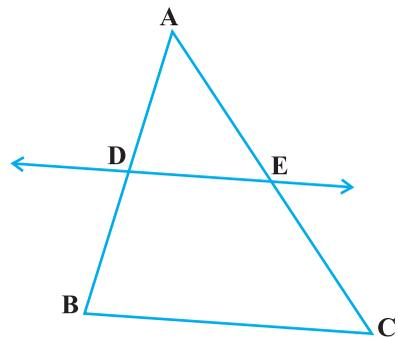


Fig. 6.13

**Example 2 :** ABCD is a trapezium with  $AB \parallel DC$ . E and F are points on non-parallel sides AD and BC respectively such that EF is parallel to AB

(see Fig. 6.14). Show that  $\frac{AE}{ED} = \frac{BF}{FC}$ .

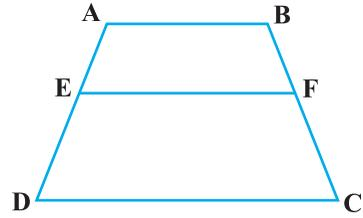


Fig. 6.14

**Solution :** Let us join AC to intersect EF at G (see Fig. 6.15).

$AB \parallel DC$  and  $EF \parallel AB$  (Given)

So,  $EF \parallel DC$  (Lines parallel to the same line are parallel to each other)

Now, in  $\triangle ADC$ ,

$EG \parallel DC$  (As  $EF \parallel DC$ )

So,  $\frac{AE}{ED} = \frac{AG}{GC}$  (Theorem 6.1) (1)

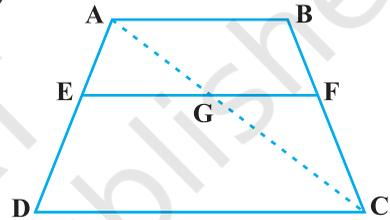


Fig. 6.15

Similarly, from  $\triangle CAB$ ,

$$\frac{CG}{AG} = \frac{CF}{BF}$$

i.e.,

$$\frac{AG}{GC} = \frac{BF}{FC} \tag{2}$$

Therefore, from (1) and (2),

$$\frac{AE}{ED} = \frac{BF}{FC}$$

**Example 3 :** In Fig. 6.16,  $\frac{PS}{SQ} = \frac{PT}{TR}$  and  $\angle PST = \angle PRQ$ . Prove that PQR is an isosceles triangle.

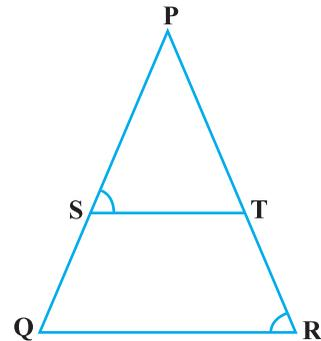


Fig. 6.16

**Solution :** It is given that  $\frac{PS}{SQ} = \frac{PT}{TR}$ .

So,  $ST \parallel QR$  (Theorem 6.2)

Therefore,  $\angle PST = \angle PQR$  (Corresponding angles) (1)

Also, it is given that

$$\angle PST = \angle PRQ \quad (2)$$

So,

$$\angle PRQ = \angle PQR \quad [\text{From (1) and (2)}]$$

Therefore,

$$PQ = PR \quad (\text{Sides opposite the equal angles})$$

i.e.,  $\triangle PQR$  is an isosceles triangle.

### EXERCISE 6.2

1. In Fig. 6.17, (i) and (ii),  $DE \parallel BC$ . Find  $EC$  in (i) and  $AD$  in (ii).

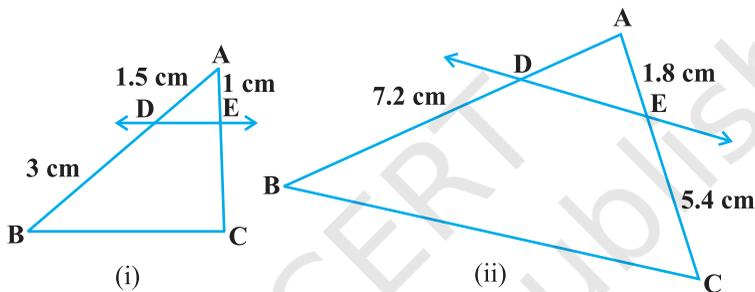


Fig. 6.17

2.  $E$  and  $F$  are points on the sides  $PQ$  and  $PR$  respectively of a  $\triangle PQR$ . For each of the following cases, state whether  $EF \parallel QR$  :

- $PE = 3.9$  cm,  $EQ = 3$  cm,  $PF = 3.6$  cm and  $FR = 2.4$  cm
- $PE = 4$  cm,  $QE = 4.5$  cm,  $PF = 8$  cm and  $RF = 9$  cm
- $PQ = 1.28$  cm,  $PR = 2.56$  cm,  $PE = 0.18$  cm and  $PF = 0.36$  cm

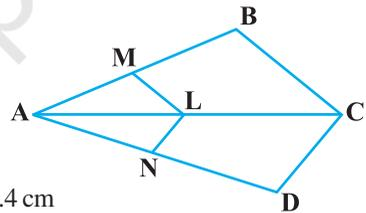


Fig. 6.18

3. In Fig. 6.18, if  $LM \parallel CB$  and  $LN \parallel CD$ , prove that

$$\frac{AM}{AB} = \frac{AN}{AD}$$

4. In Fig. 6.19,  $DE \parallel AC$  and  $DF \parallel AE$ . Prove that

$$\frac{BF}{FE} = \frac{BE}{EC}$$

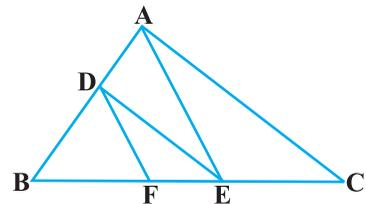


Fig. 6.19

5. In Fig. 6.20,  $DE \parallel OQ$  and  $DF \parallel OR$ . Show that  $EF \parallel QR$ .
6. In Fig. 6.21, A, B and C are points on OP, OQ and OR respectively such that  $AB \parallel PQ$  and  $AC \parallel PR$ . Show that  $BC \parallel QR$ .
7. Using Theorem 6.1, prove that a line drawn through the mid-point of one side of a triangle parallel to another side bisects the third side. (Recall that you have proved it in Class IX).
8. Using Theorem 6.2, prove that the line joining the mid-points of any two sides of a triangle is parallel to the third side. (Recall that you have done it in Class IX).
9. ABCD is a trapezium in which  $AB \parallel DC$  and its diagonals intersect each other at the point O. Show

$$\text{that } \frac{AO}{BO} = \frac{CO}{DO}.$$

10. The diagonals of a quadrilateral ABCD intersect each other at the point O such that

$$\frac{AO}{BO} = \frac{CO}{DO}. \text{ Show that ABCD is a trapezium.}$$

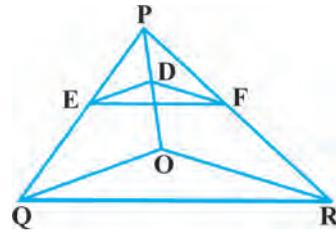


Fig. 6.20

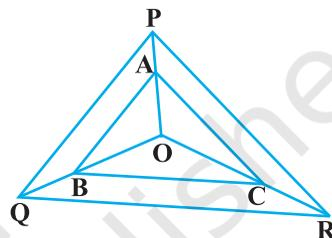


Fig. 6.21

#### 6.4 Criteria for Similarity of Triangles

In the previous section, we stated that two triangles are similar, if (i) their corresponding angles are equal and (ii) their corresponding sides are in the same ratio (or proportion).

That is, in  $\triangle ABC$  and  $\triangle DEF$ , if

- (i)  $\angle A = \angle D$ ,  $\angle B = \angle E$ ,  $\angle C = \angle F$  and

- (ii)  $\frac{AB}{DE} = \frac{BC}{EF} = \frac{CA}{FD}$ , then the two triangles are similar (see Fig. 6.22).

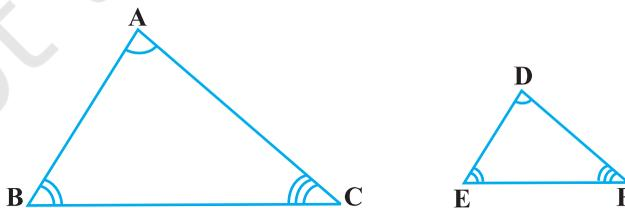


Fig. 6.22

Here, you can see that A corresponds to D, B corresponds to E and C corresponds to F. Symbolically, we write the similarity of these two triangles as ' $\Delta ABC \sim \Delta DEF$ ' and read it as 'triangle ABC is similar to triangle DEF'. The symbol ' $\sim$ ' stands for 'is similar to'. Recall that you have used the symbol ' $\cong$ ' for 'is congruent to' in Class IX.

It must be noted that as done in the case of congruency of two triangles, the similarity of two triangles should also be expressed symbolically, using correct correspondence of their vertices. For example, for the triangles ABC and DEF of Fig. 6.22, we cannot write  $\Delta ABC \sim \Delta EDF$  or  $\Delta ABC \sim \Delta FED$ . However, we can write  $\Delta BAC \sim \Delta EDF$ .

Now a natural question arises : For checking the similarity of two triangles, say ABC and DEF, should we always look for all the equality relations of their corresponding angles ( $\angle A = \angle D$ ,  $\angle B = \angle E$ ,  $\angle C = \angle F$ ) and all the equality relations of the ratios

of their corresponding sides  $\left( \frac{AB}{DE} = \frac{BC}{EF} = \frac{CA}{FD} \right)$ ? Let us examine. You may recall that

in Class IX, you have obtained some criteria for congruency of two triangles involving only three pairs of corresponding parts (or elements) of the two triangles. Here also, let us make an attempt to arrive at certain criteria for similarity of two triangles involving relationship between less number of pairs of corresponding parts of the two triangles, instead of all the six pairs of corresponding parts. For this, let us perform the following activity:

**Activity 4 :** Draw two line segments BC and EF of two different lengths, say 3 cm and 5 cm respectively. Then, at the points B and C respectively, construct angles PBC and QCB of some measures, say,  $60^\circ$  and  $40^\circ$ . Also, at the points E and F, construct angles REF and SFE of  $60^\circ$  and  $40^\circ$  respectively (see Fig. 6.23).

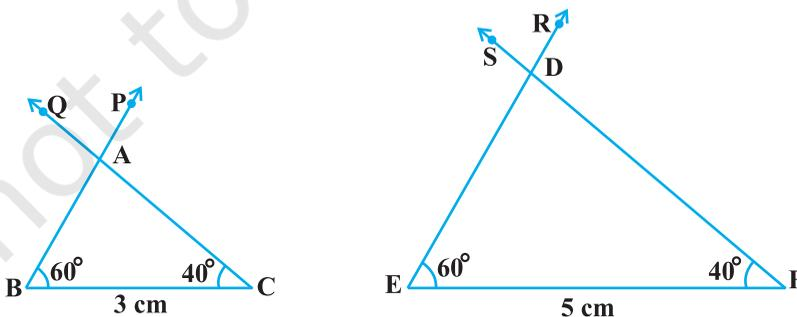


Fig. 6.23

Let rays BP and CQ intersect each other at A and rays ER and FS intersect each other at D. In the two triangles ABC and DEF, you can see that  $\angle B = \angle E$ ,  $\angle C = \angle F$  and  $\angle A = \angle D$ . That is, corresponding angles of these two triangles are equal. What can you say about their corresponding sides? Note that  $\frac{BC}{EF} = \frac{3}{5} = 0.6$ . What about  $\frac{AB}{DE}$  and  $\frac{CA}{FD}$ ? On measuring AB, DE, CA and FD, you will find that  $\frac{AB}{DE}$  and  $\frac{CA}{FD}$  are also equal to 0.6 (or nearly equal to 0.6, if there is some error in the measurement). Thus,  $\frac{AB}{DE} = \frac{BC}{EF} = \frac{CA}{FD}$ . You can repeat this activity by constructing several pairs of triangles having their corresponding angles equal. Every time, you will find that their corresponding sides are in the same ratio (or proportion). This activity leads us to the following criterion for similarity of two triangles.

**Theorem 6.3 :** *If in two triangles, corresponding angles are equal, then their corresponding sides are in the same ratio (or proportion) and hence the two triangles are similar.*

This criterion is referred to as the AAA (Angle–Angle–Angle) criterion of similarity of two triangles.

This theorem can be proved by taking two triangles ABC and DEF such that  $\angle A = \angle D$ ,  $\angle B = \angle E$  and  $\angle C = \angle F$  (see Fig. 6.24)

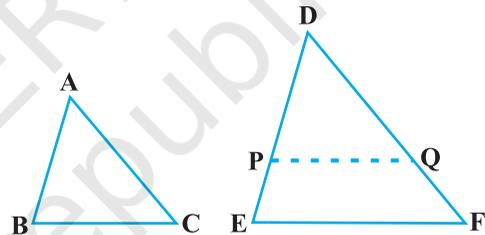


Fig. 6.24

Cut  $DP = AB$  and  $DQ = AC$  and join  $PQ$ .

So,  $\triangle ABC \cong \triangle DPQ$  (Why ?)

This gives  $\angle B = \angle P = \angle E$  and  $PQ \parallel EF$  (How?)

Therefore,  $\frac{DP}{PE} = \frac{DQ}{QF}$  (Why?)

i.e.,  $\frac{AB}{DE} = \frac{AC}{DF}$  (Why?)

Similarly,  $\frac{AB}{DE} = \frac{BC}{EF}$  and so  $\frac{AB}{DE} = \frac{BC}{EF} = \frac{AC}{DF}$ .

**Remark :** If two angles of a triangle are respectively equal to two angles of another triangle, then by the angle sum property of a triangle their third angles will also be equal. Therefore, AAA similarity criterion can also be stated as follows:

If two angles of one triangle are respectively equal to two angles of another triangle, then the two triangles are similar.

This may be referred to as the AA *similarity criterion* for two triangles.

You have seen above that if the three angles of one triangle are respectively equal to the three angles of another triangle, then their corresponding sides are proportional (i.e., in the same ratio). What about the converse of this statement? Is the converse true? In other words, if the sides of a triangle are respectively proportional to the sides of another triangle, is it true that their corresponding angles are equal? Let us examine it through an activity :

**Activity 5 :** Draw two triangles ABC and DEF such that AB = 3 cm, BC = 6 cm, CA = 8 cm, DE = 4.5 cm, EF = 9 cm and FD = 12 cm (see Fig. 6.25).

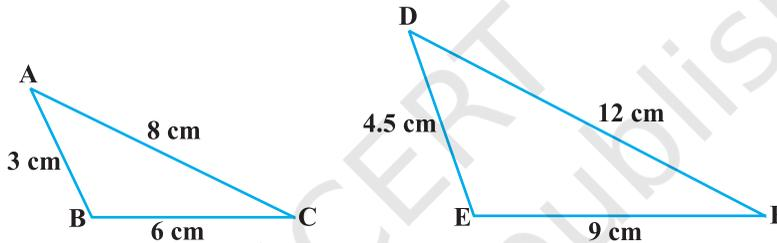


Fig. 6.25

So, you have :

$$\frac{AB}{DE} = \frac{BC}{EF} = \frac{CA}{FD} \quad (\text{each equal to } \frac{2}{3})$$

Now measure  $\angle A$ ,  $\angle B$ ,  $\angle C$ ,  $\angle D$ ,  $\angle E$  and  $\angle F$ . You will observe that  $\angle A = \angle D$ ,  $\angle B = \angle E$  and  $\angle C = \angle F$ , i.e., the corresponding angles of the two triangles are equal.

You can repeat this activity by drawing several such triangles (having their sides in the same ratio). Everytime you shall see that their corresponding angles are equal. It is due to the following criterion of similarity of two triangles:

**Theorem 6.4 :** If in two triangles, sides of one triangle are proportional to (i.e., in the same ratio of) the sides of the other triangle, then their corresponding angles are equal and hence the two triangles are similar.

This criterion is referred to as the SSS (Side–Side–Side) *similarity criterion* for two triangles.

This theorem can be proved by taking two triangles ABC and DEF such that

$$\frac{AB}{DE} = \frac{BC}{EF} = \frac{CA}{FD} (< 1) \quad (\text{see Fig. 6.26}):$$

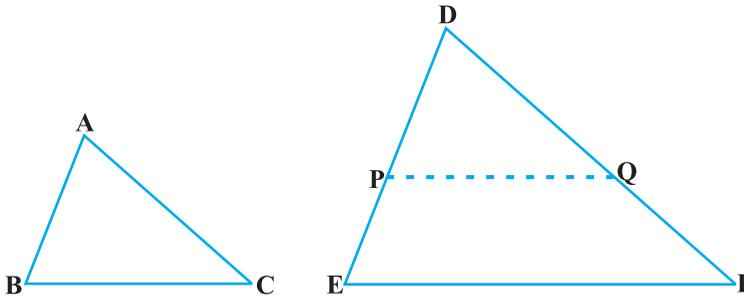


Fig. 6.26

Cut  $DP = AB$  and  $DQ = AC$  and join  $PQ$ .

It can be seen that  $\frac{DP}{PE} = \frac{DQ}{QF}$  and  $PQ \parallel EF$  (How?)

So,  $\angle P = \angle E$  and  $\angle Q = \angle F$ .

Therefore,  $\frac{DP}{DE} = \frac{DQ}{DF} = \frac{PQ}{EF}$

So,  $\frac{DP}{DE} = \frac{DQ}{DF} = \frac{BC}{EF}$  (Why?)

So,  $BC = PQ$  (Why?)

Thus,  $\triangle ABC \cong \triangle DPQ$  (Why?)

So,  $\angle A = \angle D$ ,  $\angle B = \angle E$  and  $\angle C = \angle F$  (How?)

**Remark :** You may recall that either of the two conditions namely, (i) corresponding angles are equal and (ii) corresponding sides are in the same ratio is not sufficient for two polygons to be similar. However, on the basis of Theorems 6.3 and 6.4, you can now say that in case of similarity of the two triangles, it is not necessary to check both the conditions as one condition implies the other.

Let us now recall the various criteria for congruency of two triangles learnt in Class IX. You may observe that SSS similarity criterion can be compared with the SSS congruency criterion. This suggests us to look for a similarity criterion comparable to SAS congruency criterion of triangles. For this, let us perform an activity.

**Activity 6 :** Draw two triangles  $ABC$  and  $DEF$  such that  $AB = 2$  cm,  $\angle A = 50^\circ$ ,  $AC = 4$  cm,  $DE = 3$  cm,  $\angle D = 50^\circ$  and  $DF = 6$  cm (see Fig.6.27).

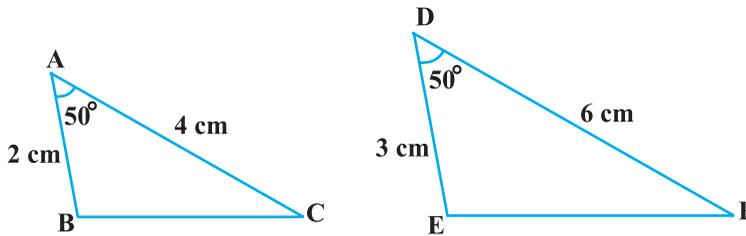


Fig. 6.27

Here, you may observe that  $\frac{AB}{DE} = \frac{AC}{DF}$  (each equal to  $\frac{2}{3}$ ) and  $\angle A$  (included between the sides AB and AC) =  $\angle D$  (included between the sides DE and DF). That is, one angle of a triangle is equal to one angle of another triangle and sides including these angles are in the same ratio (i.e., proportion). Now let us measure  $\angle B$ ,  $\angle C$ ,  $\angle E$  and  $\angle F$ .

You will find that  $\angle B = \angle E$  and  $\angle C = \angle F$ . That is,  $\angle A = \angle D$ ,  $\angle B = \angle E$  and  $\angle C = \angle F$ . So, by AAA similarity criterion,  $\Delta ABC \sim \Delta DEF$ . You may repeat this activity by drawing several pairs of such triangles with one angle of a triangle equal to one angle of another triangle and the sides including these angles are proportional. Everytime, you will find that the triangles are similar. It is due to the following criterion of similarity of triangles:

**Theorem 6.5 :** *If one angle of a triangle is equal to one angle of the other triangle and the sides including these angles are proportional, then the two triangles are similar.*

This criterion is referred to as the SAS (Side–Angle–Side) similarity criterion for two triangles.

As before, this theorem can be proved by taking two triangles ABC and DEF such that

$\frac{AB}{DE} = \frac{AC}{DF}$  ( $< 1$ ) and  $\angle A = \angle D$  (see Fig. 6.28). Cut  $DP = AB$ ,  $DQ = AC$  and join PQ.

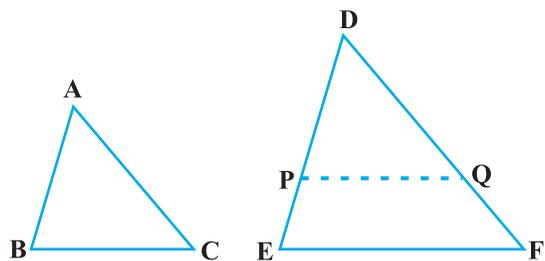


Fig. 6.28

Now,  $PQ \parallel EF$  and  $\Delta ABC \cong \Delta DPQ$  (How ?)  
 So,  $\angle A = \angle D, \angle B = \angle P$  and  $\angle C = \angle Q$   
 Therefore,  $\Delta ABC \sim \Delta DEF$  (Why?)

We now take some examples to illustrate the use of these criteria.

**Example 4 :** In Fig. 6.29, if  $PQ \parallel RS$ , prove that  $\Delta POQ \sim \Delta SOR$ .

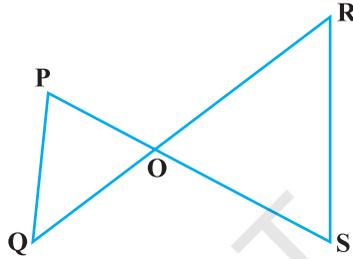


Fig. 6.29

**Solution :**  $PQ \parallel RS$  (Given)  
 So,  $\angle P = \angle S$  (Alternate angles)  
 and  $\angle Q = \angle R$   
 Also,  $\angle POQ = \angle SOR$  (Vertically opposite angles)  
 Therefore,  $\Delta POQ \sim \Delta SOR$  (AAA similarity criterion)

**Example 5 :** Observe Fig. 6.30 and then find  $\angle P$ .

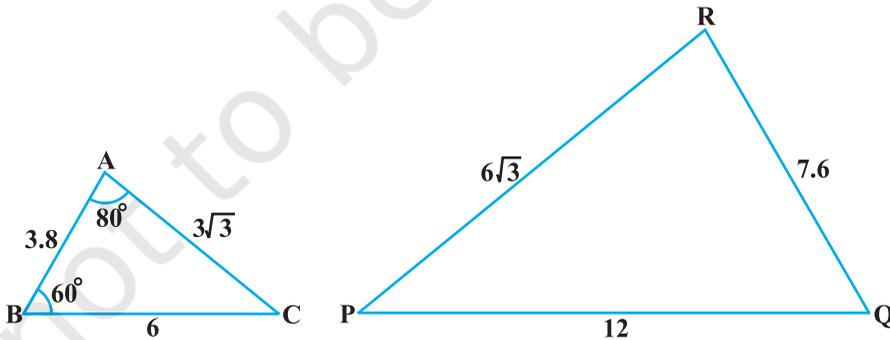


Fig. 6.30

**Solution :** In  $\Delta ABC$  and  $\Delta PQR$ ,

$$\frac{AB}{RQ} = \frac{3.8}{7.6} = \frac{1}{2}, \frac{BC}{QP} = \frac{6}{12} = \frac{1}{2} \text{ and } \frac{CA}{PR} = \frac{3\sqrt{3}}{6\sqrt{3}} = \frac{1}{2}$$

That is, 
$$\frac{AB}{RQ} = \frac{BC}{QP} = \frac{CA}{PR}$$

So,  $\triangle ABC \sim \triangle RQP$  (SSS similarity)

Therefore,  $\angle C = \angle P$  (Corresponding angles of similar triangles)

But  $\angle C = 180^\circ - \angle A - \angle B$  (Angle sum property)

$$= 180^\circ - 80^\circ - 60^\circ = 40^\circ$$

So,  $\angle P = 40^\circ$

**Example 6 :** In Fig. 6.31,

$$OA \cdot OB = OC \cdot OD.$$

Show that  $\angle A = \angle C$  and  $\angle B = \angle D$ .

**Solution :**  $OA \cdot OB = OC \cdot OD$  (Given)

So, 
$$\frac{OA}{OC} = \frac{OD}{OB} \quad (1)$$

Also, we have  $\angle AOD = \angle COB$  (Vertically opposite angles) (2)

Therefore, from (1) and (2),  $\triangle AOD \sim \triangle COB$  (SAS similarity criterion)

So,  $\angle A = \angle C$  and  $\angle D = \angle B$   
(Corresponding angles of similar triangles)

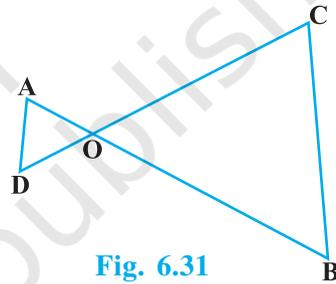


Fig. 6.31

**Example 7 :** A girl of height 90 cm is walking away from the base of a lamp-post at a speed of 1.2 m/s. If the lamp is 3.6 m above the ground, find the length of her shadow after 4 seconds.

**Solution :** Let AB denote the lamp-post and CD the girl after walking for 4 seconds away from the lamp-post (see Fig. 6.32).

From the figure, you can see that DE is the shadow of the girl. Let DE be  $x$  metres.

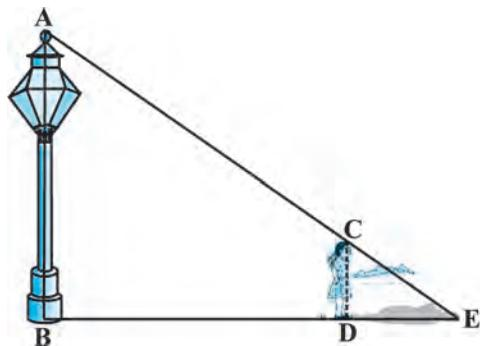


Fig. 6.32

Now,  $BD = 1.2 \text{ m} \times 4 = 4.8 \text{ m}$ .

Note that in  $\triangle ABE$  and  $\triangle CDE$ ,

$$\angle B = \angle D \quad (\text{Each is of } 90^\circ \text{ because lamp-post as well as the girl are standing vertical to the ground})$$

and  $\angle E = \angle E$  (Same angle)

So,  $\triangle ABE \sim \triangle CDE$  (AA similarity criterion)

Therefore, 
$$\frac{BE}{DE} = \frac{AB}{CD}$$

i.e., 
$$\frac{4.8 + x}{x} = \frac{3.6}{0.9} \quad (90 \text{ cm} = \frac{90}{100} \text{ m} = 0.9 \text{ m})$$

i.e., 
$$4.8 + x = 4x$$

i.e., 
$$3x = 4.8$$

i.e., 
$$x = 1.6$$

So, the shadow of the girl after walking for 4 seconds is 1.6 m long.

**Example 8 :** In Fig. 6.33, CM and RN are respectively the medians of  $\triangle ABC$  and  $\triangle PQR$ . If  $\triangle ABC \sim \triangle PQR$ , prove that :

(i)  $\triangle AMC \sim \triangle PNR$

(ii) 
$$\frac{CM}{RN} = \frac{AB}{PQ}$$

(iii)  $\triangle CMB \sim \triangle RNQ$

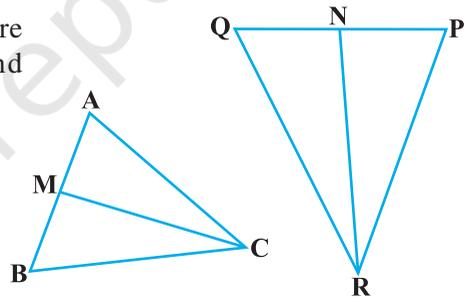


Fig. 6.33

(Given)

**Solution :** (i)  $\triangle ABC \sim \triangle PQR$

So, 
$$\frac{AB}{PQ} = \frac{BC}{QR} = \frac{CA}{RP} \quad (1)$$

and  $\angle A = \angle P, \angle B = \angle Q$  and  $\angle C = \angle R \quad (2)$

But  $AB = 2 AM$  and  $PQ = 2 PN$   
(As CM and RN are medians)

So, from (1), 
$$\frac{2AM}{2PN} = \frac{CA}{RP}$$

i.e., 
$$\frac{AM}{PN} = \frac{CA}{RP} \quad (3)$$

Also, 
$$\angle MAC = \angle NPR \quad [\text{From (2)}] \quad (4)$$

So, from (3) and (4),

$$\Delta AMC \sim \Delta PNR \quad (\text{SAS similarity}) \quad (5)$$

(ii) From (5), 
$$\frac{CM}{RN} = \frac{CA}{RP} \quad (6)$$

But 
$$\frac{CA}{RP} = \frac{AB}{PQ} \quad [\text{From (1)}] \quad (7)$$

Therefore, 
$$\frac{CM}{RN} = \frac{AB}{PQ} \quad [\text{From (6) and (7)}] \quad (8)$$

(iii) Again, 
$$\frac{AB}{PQ} = \frac{BC}{QR} \quad [\text{From (1)}]$$

Therefore, 
$$\frac{CM}{RN} = \frac{BC}{QR} \quad [\text{From (8)}] \quad (9)$$

Also, 
$$\frac{CM}{RN} = \frac{AB}{PQ} = \frac{2 BM}{2 QN}$$

i.e., 
$$\frac{CM}{RN} = \frac{BM}{QN} \quad (10)$$

i.e., 
$$\frac{CM}{RN} = \frac{BC}{QR} = \frac{BM}{QN} \quad [\text{From (9) and (10)}]$$

Therefore, 
$$\Delta CMB \sim \Delta RNQ \quad (\text{SSS similarity})$$

[**Note :** You can also prove part (iii) by following the same method as used for proving part (i).]

### EXERCISE 6.3

1. State which pairs of triangles in Fig. 6.34 are similar. Write the similarity criterion used by you for answering the question and also write the pairs of similar triangles in the symbolic form :

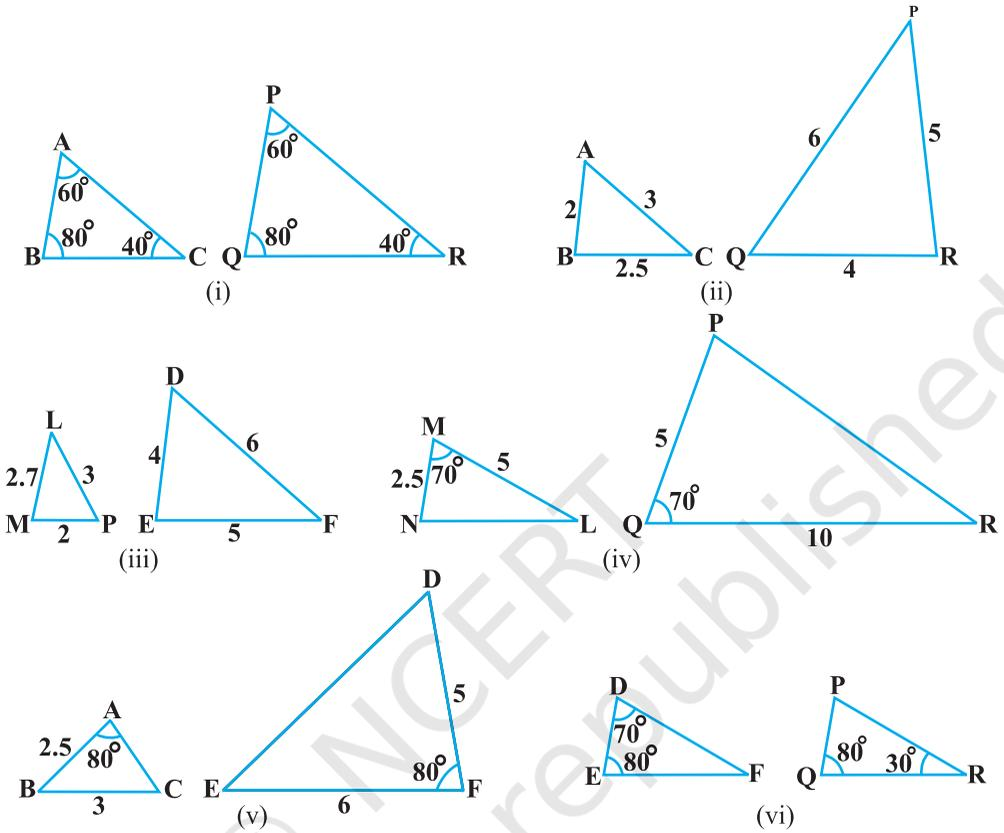


Fig. 6.34

- In Fig. 6.35,  $\triangle ODC \sim \triangle OBA$ ,  $\angle BOC = 125^\circ$  and  $\angle CDO = 70^\circ$ . Find  $\angle DOC$ ,  $\angle DCO$  and  $\angle OAB$ .
- Diagonals AC and BD of a trapezium ABCD with  $AB \parallel DC$  intersect each other at the point O. Using a similarity criterion for two triangles, show that  $\frac{OA}{OC} = \frac{OB}{OD}$ .

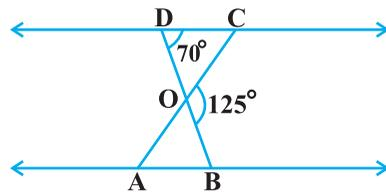


Fig. 6.35

4. In Fig. 6.36,  $\frac{QR}{QS} = \frac{QT}{PR}$  and  $\angle 1 = \angle 2$ . Show that  $\Delta PQS \sim \Delta TQR$ .

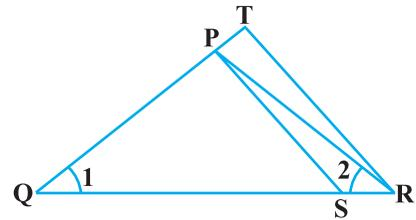


Fig. 6.36

5. S and T are points on sides PR and QR of  $\Delta PQR$  such that  $\angle P = \angle RTS$ . Show that  $\Delta RPQ \sim \Delta RTS$ .

6. In Fig. 6.37, if  $\Delta ABE \cong \Delta ACD$ , show that  $\Delta ADE \sim \Delta ABC$ .

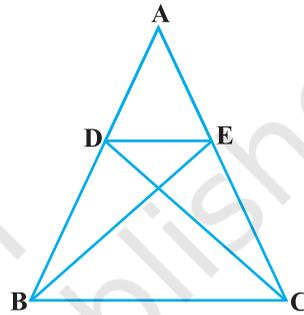


Fig. 6.37

7. In Fig. 6.38, altitudes AD and CE of  $\Delta ABC$  intersect each other at the point P. Show that:

- (i)  $\Delta AEP \sim \Delta CDP$
- (ii)  $\Delta ABD \sim \Delta CBE$
- (iii)  $\Delta AEP \sim \Delta ADB$
- (iv)  $\Delta PDC \sim \Delta BEC$

8. E is a point on the side AD produced of a parallelogram ABCD and BE intersects CD at F. Show that  $\Delta ABE \sim \Delta CFB$ .

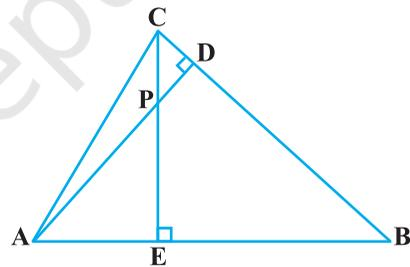


Fig. 6.38

9. In Fig. 6.39, ABC and AMP are two right triangles, right angled at B and M respectively. Prove that:

- (i)  $\Delta ABC \sim \Delta AMP$
- (ii)  $\frac{CA}{PA} = \frac{BC}{MP}$

10. CD and GH are respectively the bisectors of  $\angle ACB$  and  $\angle EGF$  such that D and H lie on sides AB and FE of  $\Delta ABC$  and  $\Delta EFG$  respectively. If  $\Delta ABC \sim \Delta FEG$ , show that:

- (i)  $\frac{CD}{GH} = \frac{AC}{FG}$
- (ii)  $\Delta DCB \sim \Delta HGE$
- (iii)  $\Delta DCA \sim \Delta HGF$

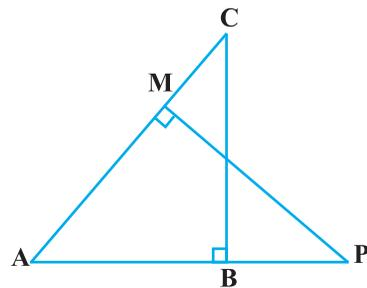


Fig. 6.39

11. In Fig. 6.40, E is a point on side CB produced of an isosceles triangle ABC with  $AB = AC$ . If  $AD \perp BC$  and  $EF \perp AC$ , prove that  $\triangle ABD \sim \triangle ECF$ .

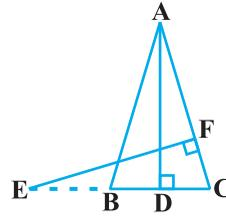


Fig. 6.40

12. Sides AB and BC and median AD of a triangle ABC are respectively proportional to sides PQ and QR and median PM of  $\triangle PQR$  (see Fig. 6.41). Show that  $\triangle ABC \sim \triangle PQR$ .

13. D is a point on the side BC of a triangle ABC such that  $\angle ADC = \angle BAC$ . Show that  $CA^2 = CB \cdot CD$ .

14. Sides AB and AC and median AD of a triangle ABC are respectively proportional to sides PQ and PR and median PM of another triangle PQR. Show that  $\triangle ABC \sim \triangle PQR$ .

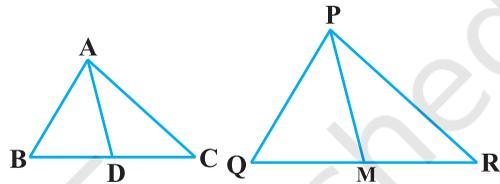


Fig. 6.41

15. A vertical pole of length 6 m casts a shadow 4 m long on the ground and at the same time a tower casts a shadow 28 m long. Find the height of the tower.

16. If AD and PM are medians of triangles ABC and PQR, respectively where

$$\triangle ABC \sim \triangle PQR, \text{ prove that } \frac{AB}{PQ} = \frac{AD}{PM}.$$

## 6.5 Areas of Similar Triangles

You have learnt that in two similar triangles, the ratio of their corresponding sides is the same. Do you think there is any relationship between the ratio of their areas and the ratio of the corresponding sides? You know that area is measured in square units. So, you may expect that this ratio is the square of the ratio of their corresponding sides. This is indeed true and we shall prove it in the next theorem.

**Theorem 6.6 :** *The ratio of the areas of two similar triangles is equal to the square of the ratio of their corresponding sides.*

**Proof :** We are given two triangles ABC and PQR such that  $\triangle ABC \sim \triangle PQR$  (see Fig. 6.42).

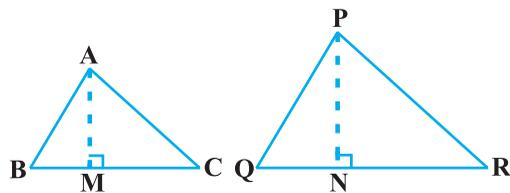


Fig. 6.42

We need to prove that  $\frac{\text{ar}(\text{ABC})}{\text{ar}(\text{PQR})} = \left(\frac{\text{AB}}{\text{PQ}}\right)^2 = \left(\frac{\text{BC}}{\text{QR}}\right)^2 = \left(\frac{\text{CA}}{\text{RP}}\right)^2$ .

For finding the areas of the two triangles, we draw altitudes AM and PN of the triangles.

Now, 
$$\text{ar}(\text{ABC}) = \frac{1}{2} \text{BC} \times \text{AM}$$

and 
$$\text{ar}(\text{PQR}) = \frac{1}{2} \text{QR} \times \text{PN}$$

So, 
$$\frac{\text{ar}(\text{ABC})}{\text{ar}(\text{PQR})} = \frac{\frac{1}{2} \times \text{BC} \times \text{AM}}{\frac{1}{2} \times \text{QR} \times \text{PN}} = \frac{\text{BC} \times \text{AM}}{\text{QR} \times \text{PN}} \quad (1)$$

Now, in  $\Delta \text{ABM}$  and  $\Delta \text{PQN}$ ,

$$\angle \text{B} = \angle \text{Q} \quad (\text{As } \Delta \text{ABC} \sim \Delta \text{PQR})$$

and 
$$\angle \text{M} = \angle \text{N} \quad (\text{Each is of } 90^\circ)$$

So, 
$$\Delta \text{ABM} \sim \Delta \text{PQN} \quad (\text{AA similarity criterion})$$

Therefore, 
$$\frac{\text{AM}}{\text{PN}} = \frac{\text{AB}}{\text{PQ}} \quad (2)$$

Also, 
$$\Delta \text{ABC} \sim \Delta \text{PQR} \quad (\text{Given})$$

So, 
$$\frac{\text{AB}}{\text{PQ}} = \frac{\text{BC}}{\text{QR}} = \frac{\text{CA}}{\text{RP}} \quad (3)$$

Therefore, 
$$\frac{\text{ar}(\text{ABC})}{\text{ar}(\text{PQR})} = \frac{\text{AB}}{\text{PQ}} \times \frac{\text{AM}}{\text{PN}} \quad [\text{From (1) and (3)}]$$

$$= \frac{\text{AB}}{\text{PQ}} \times \frac{\text{AB}}{\text{PQ}} \quad [\text{From (2)}]$$

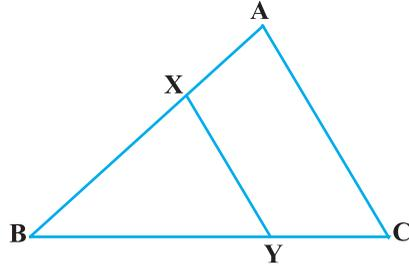
$$= \left(\frac{\text{AB}}{\text{PQ}}\right)^2$$

Now using (3), we get

$$\frac{\text{ar}(\text{ABC})}{\text{ar}(\text{PQR})} = \left(\frac{\text{AB}}{\text{PQ}}\right)^2 = \left(\frac{\text{BC}}{\text{QR}}\right)^2 = \left(\frac{\text{CA}}{\text{RP}}\right)^2$$

Let us take an example to illustrate the use of this theorem.

**Example 9 :** In Fig. 6.43, the line segment XY is parallel to side AC of  $\Delta ABC$  and it divides the triangle into two parts of equal areas. Find the ratio  $\frac{AX}{AB}$ .



**Fig. 6.43**

**Solution :** We have  $XY \parallel AC$  (Given)  
 So,  $\angle BXY = \angle A$  and  $\angle BYX = \angle C$  (Corresponding angles)  
 Therefore,  $\Delta ABC \sim \Delta XBY$  (AA similarity criterion)

So, 
$$\frac{\text{ar}(\Delta ABC)}{\text{ar}(\Delta XBY)} = \left(\frac{AB}{XB}\right)^2 \quad \text{(Theorem 6.6)} \quad (1)$$

Also, 
$$\text{ar}(\Delta ABC) = 2 \text{ar}(\Delta XBY) \quad \text{(Given)}$$

So, 
$$\frac{\text{ar}(\Delta ABC)}{\text{ar}(\Delta XBY)} = \frac{2}{1} \quad (2)$$

Therefore, from (1) and (2),

$$\left(\frac{AB}{XB}\right)^2 = \frac{2}{1}, \text{ i.e., } \frac{AB}{XB} = \frac{\sqrt{2}}{1}$$

or, 
$$\frac{XB}{AB} = \frac{1}{\sqrt{2}}$$

or, 
$$1 - \frac{XB}{AB} = 1 - \frac{1}{\sqrt{2}}$$

or, 
$$\frac{AB - XB}{AB} = \frac{\sqrt{2} - 1}{\sqrt{2}}, \text{ i.e., } \frac{AX}{AB} = \frac{\sqrt{2} - 1}{\sqrt{2}} = \frac{2 - \sqrt{2}}{2}.$$

**EXERCISE 6.4**

1. Let  $\Delta ABC \sim \Delta DEF$  and their areas be, respectively,  $64 \text{ cm}^2$  and  $121 \text{ cm}^2$ . If  $EF = 15.4 \text{ cm}$ , find  $BC$ .
2. Diagonals of a trapezium  $ABCD$  with  $AB \parallel DC$  intersect each other at the point  $O$ . If  $AB = 2 \text{ CD}$ , find the ratio of the areas of triangles  $AOB$  and  $COD$ .

3. In Fig. 6.44, ABC and DBC are two triangles on the same base BC. If AD intersects BC at O, show that

$$\frac{\text{ar}(\triangle ABC)}{\text{ar}(\triangle DBC)} = \frac{AO}{DO}$$

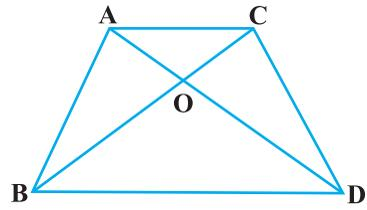


Fig. 6.44

4. If the areas of two similar triangles are equal, prove that they are congruent.
5. D, E and F are respectively the mid-points of sides AB, BC and CA of  $\triangle ABC$ . Find the ratio of the areas of  $\triangle DEF$  and  $\triangle ABC$ .
6. Prove that the ratio of the areas of two similar triangles is equal to the square of the ratio of their corresponding medians.
7. Prove that the area of an equilateral triangle described on one side of a square is equal to half the area of the equilateral triangle described on one of its diagonals.

**Tick the correct answer and justify :**

8. ABC and BDE are two equilateral triangles such that D is the mid-point of BC. Ratio of the areas of triangles ABC and BDE is  
 (A) 2 : 1                      (B) 1 : 2                      (C) 4 : 1                      (D) 1 : 4
9. Sides of two similar triangles are in the ratio 4 : 9. Areas of these triangles are in the ratio  
 (A) 2 : 3                      (B) 4 : 9                      (C) 81 : 16                      (D) 16 : 81

## 6.6 Pythagoras Theorem

You are already familiar with the Pythagoras Theorem from your earlier classes. You had verified this theorem through some activities and made use of it in solving certain problems. You have also seen a proof of this theorem in Class IX. Now, we shall prove this theorem using the concept of similarity of triangles. In proving this, we shall make use of a result related to similarity of two triangles formed by the perpendicular to the hypotenuse from the opposite vertex of the right triangle.

Now, let us take a right triangle ABC, right angled at B. Let BD be the perpendicular to the hypotenuse AC (see Fig. 6.45).

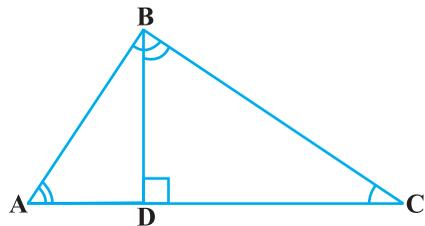


Fig. 6.45

You may note that in  $\triangle ADB$  and  $\triangle ABC$

$$\angle A = \angle A$$

and  $\angle ADB = \angle ABC$  (Why?)

So,  $\triangle ADB \sim \triangle ABC$  (How?) (1)

Similarly,  $\triangle BDC \sim \triangle ABC$  (How?) (2)

So, from (1) and (2), triangles on both sides of the perpendicular BD are similar to the whole triangle ABC.

Also, since  $\triangle ADB \sim \triangle ABC$

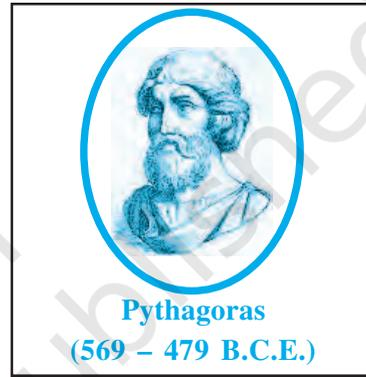
and  $\triangle BDC \sim \triangle ABC$

So,  $\triangle ADB \sim \triangle BDC$  (From Remark in Section 6.2)

The above discussion leads to the following theorem :

**Theorem 6.7 :** *If a perpendicular is drawn from the vertex of the right angle of a right triangle to the hypotenuse then triangles on both sides of the perpendicular are similar to the whole triangle and to each other.*

Let us now apply this theorem in proving the Pythagoras Theorem:



**Theorem 6.8 :** *In a right triangle, the square of the hypotenuse is equal to the sum of the squares of the other two sides.*

**Proof :** We are given a right triangle ABC right angled at B.

We need to prove that  $AC^2 = AB^2 + BC^2$

Let us draw  $BD \perp AC$  (see Fig. 6.46).

Now,  $\triangle ADB \sim \triangle ABC$  (Theorem 6.7)

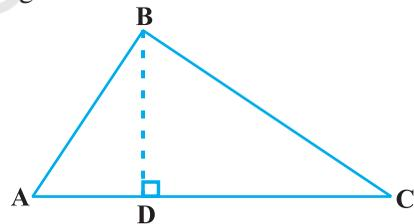
So,  $\frac{AD}{AB} = \frac{AB}{AC}$  (Sides are proportional)

or,  $AD \cdot AC = AB^2$  (1)

Also,  $\triangle BDC \sim \triangle ABC$  (Theorem 6.7)

So,  $\frac{CD}{BC} = \frac{BC}{AC}$

or,  $CD \cdot AC = BC^2$  (2)



**Fig. 6.46**

Adding (1) and (2),

$$AD \cdot AC + CD \cdot AC = AB^2 + BC^2$$

or,  $AC (AD + CD) = AB^2 + BC^2$

or,  $AC \cdot AC = AB^2 + BC^2$

or,  $AC^2 = AB^2 + BC^2$

The above theorem was earlier given by an ancient Indian mathematician Baudhayana (about 800 B.C.E.) in the following form :

*The diagonal of a rectangle produces by itself the same area as produced by its both sides (i.e., length and breadth).*

For this reason, this theorem is sometimes also referred to as the *Baudhayana Theorem*.

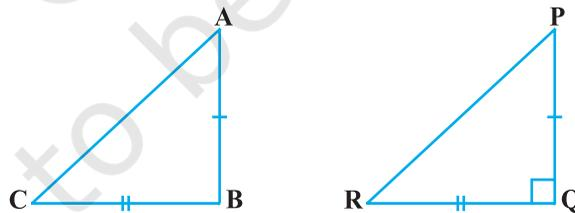
What about the converse of the Pythagoras Theorem? You have already verified, in the earlier classes, that this is also true. We now prove it in the form of a theorem.

**Theorem 6.9 :** *In a triangle, if square of one side is equal to the sum of the squares of the other two sides, then the angle opposite the first side is a right angle.*

**Proof :** Here, we are given a triangle ABC in which  $AC^2 = AB^2 + BC^2$ .

We need to prove that  $\angle B = 90^\circ$ .

To start with, we construct a  $\Delta PQR$  right angled at Q such that  $PQ = AB$  and  $QR = BC$  (see Fig. 6.47).



**Fig. 6.47**

Now, from  $\Delta PQR$ , we have :

$$PR^2 = PQ^2 + QR^2 \quad \text{(Pythagoras Theorem, as } \angle Q = 90^\circ \text{)}$$

or,  $PR^2 = AB^2 + BC^2$  (By construction) (1)

But  $AC^2 = AB^2 + BC^2$  (Given) (2)

So,  $AC = PR$  [From (1) and (2)] (3)

Now, in  $\triangle ABC$  and  $\triangle PQR$ ,

$AB = PQ$  (By construction)

$BC = QR$  (By construction)

$AC = PR$  [Proved in (3) above]

So,  $\triangle ABC \cong \triangle PQR$  (SSS congruence)

Therefore,  $\angle B = \angle Q$  (CPCT)

But  $\angle Q = 90^\circ$  (By construction)

So,  $\angle B = 90^\circ$

**Note :** Also see Appendix 1 for another proof of this theorem.

Let us now take some examples to illustrate the use of these theorems.

**Example 10 :** In Fig. 6.48,  $\angle ACB = 90^\circ$

and  $CD \perp AB$ . Prove that  $\frac{BC^2}{AC^2} = \frac{BD}{AD}$ .

**Solution :**  $\triangle ACD \sim \triangle ABC$   
(Theorem 6.7)

So,  $\frac{AC}{AB} = \frac{AD}{AC}$

or,  $AC^2 = AB \cdot AD$  (1)

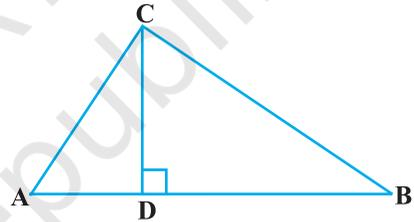
Similarly,  $\triangle BCD \sim \triangle BAC$  (Theorem 6.7)

So,  $\frac{BC}{BA} = \frac{BD}{BC}$

or,  $BC^2 = BA \cdot BD$  (2)

Therefore, from (1) and (2),

$$\frac{BC^2}{AC^2} = \frac{BA \cdot BD}{AB \cdot AD} = \frac{BD}{AD}$$



**Fig. 6.48**

**Example 11 :** A ladder is placed against a wall such that its foot is at a distance of 2.5 m from the wall and its top reaches a window 6 m above the ground. Find the length of the ladder.

**Solution :** Let AB be the ladder and CA be the wall with the window at A (see Fig. 6.49).

Also,  $BC = 2.5$  m and  $CA = 6$  m

From Pythagoras Theorem, we have:

$$\begin{aligned} AB^2 &= BC^2 + CA^2 \\ &= (2.5)^2 + (6)^2 \\ &= 42.25 \end{aligned}$$

So,  $AB = 6.5$

Thus, length of the ladder is 6.5 m.

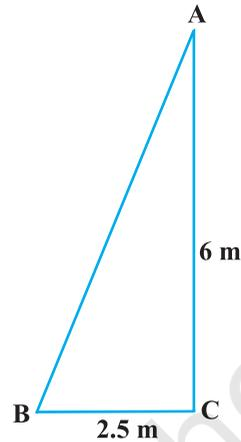


Fig. 6.49

**Example 12 :** In Fig. 6.50, if  $AD \perp BC$ , prove that  $AB^2 + CD^2 = BD^2 + AC^2$ .

**Solution :** From  $\triangle ADC$ , we have

$$\begin{aligned} AC^2 &= AD^2 + CD^2 \\ &\text{(Pythagoras Theorem) (1)} \end{aligned}$$

From  $\triangle ADB$ , we have

$$\begin{aligned} AB^2 &= AD^2 + BD^2 \\ &\text{(Pythagoras Theorem) (2)} \end{aligned}$$

Subtracting (1) from (2), we have

$$AB^2 - AC^2 = BD^2 - CD^2$$

or,  $AB^2 + CD^2 = BD^2 + AC^2$

**Example 13 :** BL and CM are medians of a triangle ABC right angled at A. Prove that  $4(BL^2 + CM^2) = 5BC^2$ .

**Solution :** BL and CM are medians of the  $\triangle ABC$  in which  $\angle A = 90^\circ$  (see Fig. 6.51).

From  $\triangle ABC$ ,

$$BC^2 = AB^2 + AC^2 \quad \text{(Pythagoras Theorem) (1)}$$

From  $\triangle ABL$ ,

$$BL^2 = AL^2 + AB^2$$

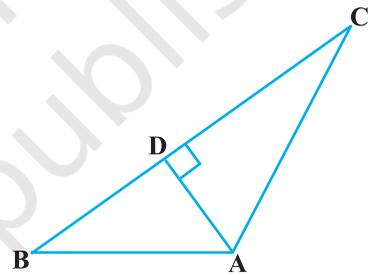


Fig. 6.50

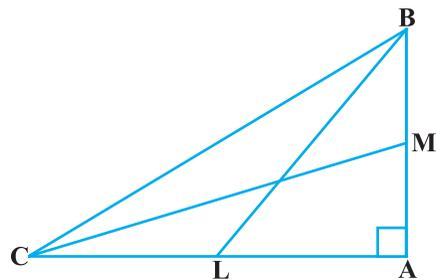


Fig. 6.51

or, 
$$BL^2 = \left(\frac{AC}{2}\right)^2 + AB^2 \quad (\text{L is the mid-point of AC})$$

or, 
$$BL^2 = \frac{AC^2}{4} + AB^2$$

or, 
$$4 BL^2 = AC^2 + 4 AB^2 \quad (2)$$

From  $\Delta CMA$ ,

$$CM^2 = AC^2 + AM^2$$

or, 
$$CM^2 = AC^2 + \left(\frac{AB}{2}\right)^2 \quad (\text{M is the mid-point of AB})$$

or, 
$$CM^2 = AC^2 + \frac{AB^2}{4}$$

or 
$$4 CM^2 = 4 AC^2 + AB^2 \quad (3)$$

Adding (2) and (3), we have

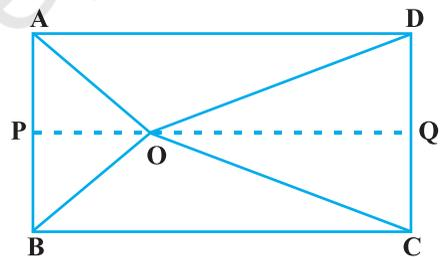
$$4 (BL^2 + CM^2) = 5 (AC^2 + AB^2)$$

i.e., 
$$4 (BL^2 + CM^2) = 5 BC^2 \quad [\text{From (1)}]$$

**Example 14 :** O is any point inside a rectangle ABCD (see Fig. 6.52). Prove that  $OB^2 + OD^2 = OA^2 + OC^2$ .

**Solution :**

Through O, draw  $PQ \parallel BC$  so that P lies on AB and Q lies on DC.



**Fig. 6.52**

Now, 
$$PQ \parallel BC$$

Therefore, 
$$PQ \perp AB \text{ and } PQ \perp DC \quad (\angle B = 90^\circ \text{ and } \angle C = 90^\circ)$$

So, 
$$\angle BPQ = 90^\circ \text{ and } \angle CQP = 90^\circ$$

Therefore, BPQC and APQD are both rectangles.

Now, from  $\Delta OPB$ ,

$$OB^2 = BP^2 + OP^2 \quad (1)$$

Similarly, from  $\Delta OQD$ ,

$$OD^2 = OQ^2 + DQ^2 \quad (2)$$

From  $\Delta OQC$ , we have

$$OC^2 = OQ^2 + CQ^2 \quad (3)$$

and from  $\Delta OAP$ , we have

$$OA^2 = AP^2 + OP^2 \quad (4)$$

Adding (1) and (2),

$$\begin{aligned} OB^2 + OD^2 &= BP^2 + OP^2 + OQ^2 + DQ^2 \\ &= CQ^2 + OP^2 + OQ^2 + AP^2 \\ &\quad \text{(As } BP = CQ \text{ and } DQ = AP) \\ &= CQ^2 + OQ^2 + OP^2 + AP^2 \\ &= OC^2 + OA^2 \quad \text{[From (3) and (4)]} \end{aligned}$$

### EXERCISE 6.5

1. Sides of triangles are given below. Determine which of them are right triangles. In case of a right triangle, write the length of its hypotenuse.

- (i) 7 cm, 24 cm, 25 cm
- (ii) 3 cm, 8 cm, 6 cm
- (iii) 50 cm, 80 cm, 100 cm
- (iv) 13 cm, 12 cm, 5 cm

2.  $PQR$  is a triangle right angled at  $P$  and  $M$  is a point on  $QR$  such that  $PM \perp QR$ . Show that  $PM^2 = QM \cdot MR$ .

3. In Fig. 6.53,  $ABD$  is a triangle right angled at  $A$  and  $AC \perp BD$ . Show that

- (i)  $AB^2 = BC \cdot BD$
- (ii)  $AC^2 = BC \cdot DC$
- (iii)  $AD^2 = BD \cdot CD$

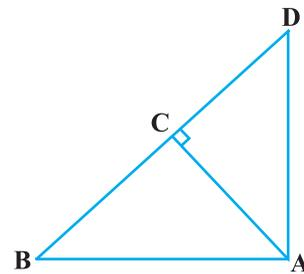


Fig. 6.53

4.  $ABC$  is an isosceles triangle right angled at  $C$ . Prove that  $AB^2 = 2AC^2$ .
5.  $ABC$  is an isosceles triangle with  $AC = BC$ . If  $AB^2 = 2AC^2$ , prove that  $ABC$  is a right triangle.
6.  $ABC$  is an equilateral triangle of side  $2a$ . Find each of its altitudes.
7. Prove that the sum of the squares of the sides of a rhombus is equal to the sum of the squares of its diagonals.

8. In Fig. 6.54, O is a point in the interior of a triangle ABC,  $OD \perp BC$ ,  $OE \perp AC$  and  $OF \perp AB$ . Show that
- $OA^2 + OB^2 + OC^2 - OD^2 - OE^2 - OF^2 = AF^2 + BD^2 + CE^2$ ,
  - $AF^2 + BD^2 + CE^2 = AE^2 + CD^2 + BF^2$ .

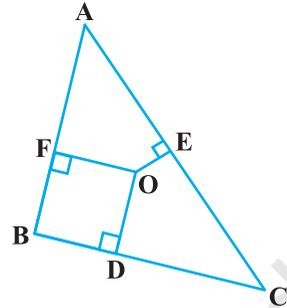


Fig. 6.54

9. A ladder 10 m long reaches a window 8 m above the ground. Find the distance of the foot of the ladder from base of the wall.
10. A guy wire attached to a vertical pole of height 18 m is 24 m long and has a stake attached to the other end. How far from the base of the pole should the stake be driven so that the wire will be taut?
11. An aeroplane leaves an airport and flies due north at a speed of 1000 km per hour. At the same time, another aeroplane leaves the same airport and flies due west at a speed of 1200 km per hour. How far apart will be the two planes after  $1\frac{1}{2}$  hours?
12. Two poles of heights 6 m and 11 m stand on a plane ground. If the distance between the feet of the poles is 12 m, find the distance between their tops.
13. D and E are points on the sides CA and CB respectively of a triangle ABC right angled at C. Prove that  $AE^2 + BD^2 = AB^2 + DE^2$ .
14. The perpendicular from A on side BC of a  $\triangle ABC$  intersects BC at D such that  $DB = 3 CD$  (see Fig. 6.55). Prove that  $2 AB^2 = 2 AC^2 + BC^2$ .

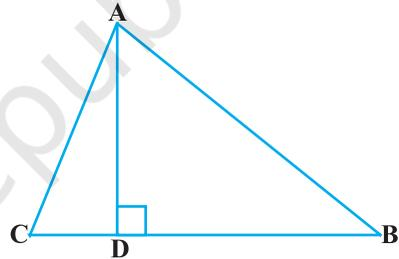
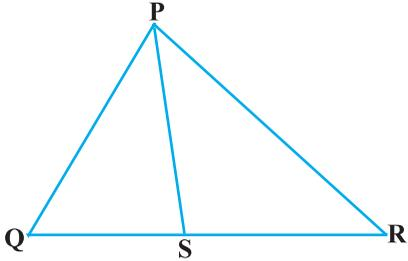


Fig. 6.55

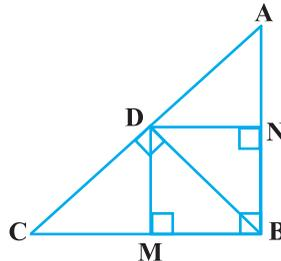
15. In an equilateral triangle ABC, D is a point on side BC such that  $BD = \frac{1}{3} BC$ . Prove that  $9 AD^2 = 7 AB^2$ .
16. In an equilateral triangle, prove that three times the square of one side is equal to four times the square of one of its altitudes.
17. Tick the correct answer and justify : In  $\triangle ABC$ ,  $AB = 6\sqrt{3}$  cm,  $AC = 12$  cm and  $BC = 6$  cm. The angle B is :
- |                 |                |
|-----------------|----------------|
| (A) $120^\circ$ | (B) $60^\circ$ |
| (C) $90^\circ$  | (D) $45^\circ$ |

**EXERCISE 6.6 (Optional)\***

- In Fig. 6.56, PS is the bisector of  $\angle QPR$  of  $\Delta PQR$ . Prove that  $\frac{QS}{SR} = \frac{PQ}{PR}$ .

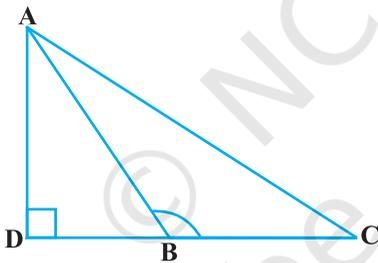


**Fig. 6.56**

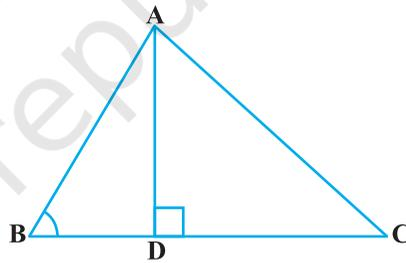


**Fig. 6.57**

- In Fig. 6.57, D is a point on hypotenuse AC of  $\Delta ABC$ , such that  $BD \perp AC$ ,  $DM \perp BC$  and  $DN \perp AB$ . Prove that :
  - $DM^2 = DN \cdot MC$
  - $DN^2 = DM \cdot AN$
- In Fig. 6.58, ABC is a triangle in which  $\angle ABC > 90^\circ$  and  $AD \perp CB$  produced. Prove that  $AC^2 = AB^2 + BC^2 + 2 BC \cdot BD$ .



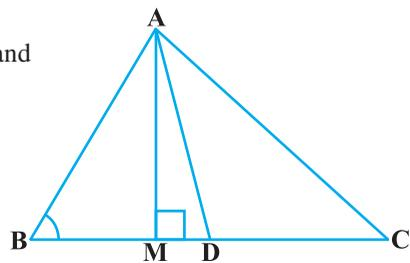
**Fig. 6.58**



**Fig. 6.59**

- In Fig. 6.59, ABC is a triangle in which  $\angle ABC < 90^\circ$  and  $AD \perp BC$ . Prove that  $AC^2 = AB^2 + BC^2 - 2 BC \cdot BD$ .
- In Fig. 6.60, AD is a median of a triangle ABC and  $AM \perp BC$ . Prove that :

- $AC^2 = AD^2 + BC \cdot DM + \left(\frac{BC}{2}\right)^2$



**Fig. 6.60**

\* These exercises are not from examination point of view.

(ii)  $AB^2 = AD^2 - BC \cdot DM + \left(\frac{BC}{2}\right)^2$

(iii)  $AC^2 + AB^2 = 2AD^2 + \frac{1}{2}BC^2$

6. Prove that the sum of the squares of the diagonals of parallelogram is equal to the sum of the squares of its sides.

7. In Fig. 6.61, two chords AB and CD intersect each other at the point P. Prove that :

(i)  $\Delta APC \sim \Delta DPB$

(ii)  $AP \cdot PB = CP \cdot DP$

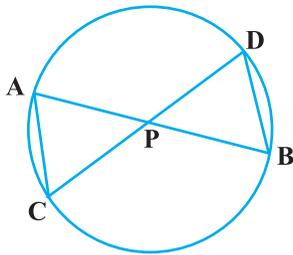


Fig. 6.61

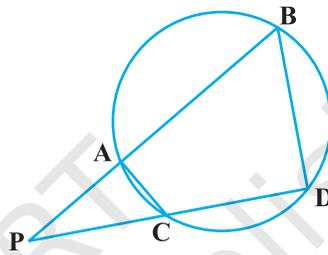


Fig. 6.62

8. In Fig. 6.62, two chords AB and CD of a circle intersect each other at the point P (when produced) outside the circle. Prove that

(i)  $\Delta PAC \sim \Delta PDB$

(ii)  $PA \cdot PB = PC \cdot PD$

9. In Fig. 6.63, D is a point on side BC of  $\Delta ABC$

such that  $\frac{BD}{CD} = \frac{AB}{AC}$ . Prove that AD is the bisector of  $\angle BAC$ .

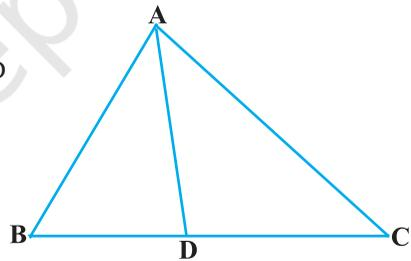


Fig. 6.63

10. Nazima is fly fishing in a stream. The tip of her fishing rod is 1.8 m above the surface of the water and the fly at the end of the string rests on the water 3.6 m away and 2.4 m from a point directly under the tip of the rod. Assuming that her string (from the tip of her rod to the fly) is taut, how much string does she have out (see Fig. 6.64)? If she pulls in the string at the rate of 5 cm per second, what will be the horizontal distance of the fly from her after 12 seconds?

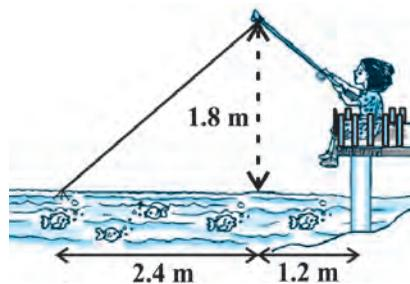


Fig. 6.64

## 6.7 Summary

In this chapter you have studied the following points :

1. Two figures having the same shape but not necessarily the same size are called similar figures.
2. All the congruent figures are similar but the converse is not true.
3. Two polygons of the same number of sides are similar, if (i) their corresponding angles are equal and (ii) their corresponding sides are in the same ratio (i.e., proportion).
4. If a line is drawn parallel to one side of a triangle to intersect the other two sides in distinct points, then the other two sides are divided in the same ratio.
5. If a line divides any two sides of a triangle in the same ratio, then the line is parallel to the third side.
6. If in two triangles, corresponding angles are equal, then their corresponding sides are in the same ratio and hence the two triangles are similar (AAA similarity criterion).
7. If in two triangles, two angles of one triangle are respectively equal to the two angles of the other triangle, then the two triangles are similar (AA similarity criterion).
8. If in two triangles, corresponding sides are in the same ratio, then their corresponding angles are equal and hence the triangles are similar (SSS similarity criterion).
9. If one angle of a triangle is equal to one angle of another triangle and the sides including these angles are in the same ratio (proportional), then the triangles are similar (SAS similarity criterion).
10. The ratio of the areas of two similar triangles is equal to the square of the ratio of their corresponding sides.
11. If a perpendicular is drawn from the vertex of the right angle of a right triangle to the hypotenuse, then the triangles on both sides of the perpendicular are similar to the whole triangle and also to each other.
12. In a right triangle, the square of the hypotenuse is equal to the sum of the squares of the other two sides (Pythagoras Theorem).
13. If in a triangle, square of one side is equal to the sum of the squares of the other two sides, then the angle opposite the first side is a right angle.

### A NOTE TO THE READER

If in two right triangles, hypotenuse and one side of one triangle are proportional to the hypotenuse and one side of the other triangle, then the two triangles are similar. This may be referred to as the RHS Similarity Criterion.

If you use this criterion in Example 2, Chapter 8, the proof will become simpler.



1062CH07

# COORDINATE GEOMETRY

# 7

## 7.1 Introduction

In Class IX, you have studied that to locate the position of a point on a plane, we require a pair of coordinate axes. The distance of a point from the  $y$ -axis is called its  **$x$ -coordinate**, or **abscissa**. The distance of a point from the  $x$ -axis is called its  **$y$ -coordinate**, or **ordinate**. The coordinates of a point on the  $x$ -axis are of the form  $(x, 0)$ , and of a point on the  $y$ -axis are of the form  $(0, y)$ .

Here is a play for you. Draw a set of a pair of perpendicular axes on a graph paper. Now plot the following points and join them as directed: Join the point A(4, 8) to B(3, 9) to C(3, 8) to D(1, 6) to E(1, 5) to F(3, 3) to G(6, 3) to H(8, 5) to I(8, 6) to J(6, 8) to K(6, 9) to L(5, 8) to A. Then join the points P(3.5, 7), Q(3, 6) and R(4, 6) to form a triangle. Also join the points X(5.5, 7), Y(5, 6) and Z(6, 6) to form a triangle. Now join S(4, 5), T(4.5, 4) and U(5, 5) to form a triangle. Lastly join S to the points (0, 5) and (0, 6) and join U to the points (9, 5) and (9, 6). What picture have you got?

Also, you have seen that a linear equation in two variables of the form  $ax + by + c = 0$ , ( $a, b$  are not simultaneously zero), when represented graphically, gives a straight line. Further, in Chapter 2, you have seen the graph of  $y = ax^2 + bx + c$  ( $a \neq 0$ ), is a parabola. In fact, coordinate geometry has been developed as an algebraic tool for studying geometry of figures. It helps us to study geometry using algebra, and understand algebra with the help of geometry. Because of this, coordinate geometry is widely applied in various fields such as physics, engineering, navigation, seismology and art!

In this chapter, you will learn how to find the distance between the two points whose coordinates are given, and to find the area of the triangle formed by three given points. You will also study how to find the coordinates of the point which divides a line segment joining two given points in a given ratio.

## 7.2 Distance Formula

Let us consider the following situation:

A town B is located 36 km east and 15 km north of the town A. How would you find the distance from town A to town B without actually measuring it. Let us see. This situation can be represented graphically as shown in Fig. 7.1. You may use the Pythagoras Theorem to calculate this distance.

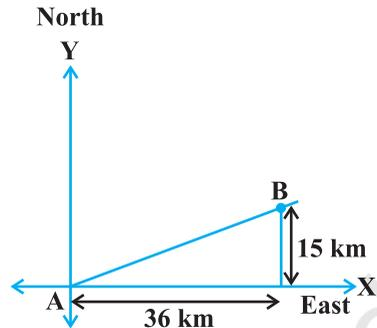


Fig. 7.1

Now, suppose two points lie on the  $x$ -axis. Can we find the distance between them? For instance, consider two points  $A(4, 0)$  and  $B(6, 0)$  in Fig. 7.2. The points A and B lie on the  $x$ -axis.

From the figure you can see that  $OA = 4$  units and  $OB = 6$  units.

Therefore, the distance of B from A, i.e.,  $AB = OB - OA = 6 - 4 = 2$  units.

So, if two points lie on the  $x$ -axis, we can easily find the distance between them.

Now, suppose we take two points lying on the  $y$ -axis. Can you find the distance between them. If the points  $C(0, 3)$  and  $D(0, 8)$  lie on the  $y$ -axis, similarly we find that  $CD = 8 - 3 = 5$  units (see Fig. 7.2).

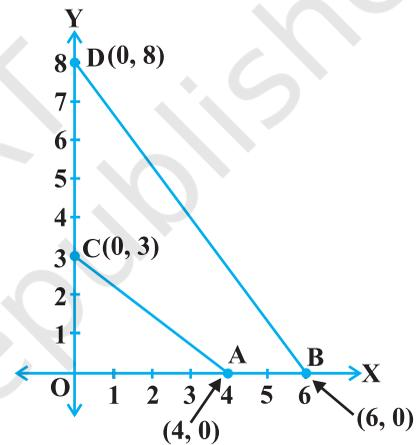


Fig. 7.2

Next, can you find the distance of A from C (in Fig. 7.2)? Since  $OA = 4$  units and  $OC = 3$  units, the distance of A from C, i.e.,  $AC = \sqrt{3^2 + 4^2} = 5$  units. Similarly, you can find the distance of B from D =  $BD = 10$  units.

Now, if we consider two points not lying on coordinate axis, can we find the distance between them? Yes! We shall use Pythagoras theorem to do so. Let us see an example.

In Fig. 7.3, the points  $P(4, 6)$  and  $Q(6, 8)$  lie in the first quadrant. How do we use Pythagoras theorem to find the distance between them? Let us draw  $PR$  and  $QS$  perpendicular to the  $x$ -axis from  $P$  and  $Q$  respectively. Also, draw a perpendicular from  $P$  on  $QS$  to meet  $QS$  at  $T$ . Then the coordinates of  $R$  and  $S$  are  $(4, 0)$  and  $(6, 0)$ , respectively. So,  $RS = 2$  units. Also,  $QS = 8$  units and  $TS = PR = 6$  units.

Therefore,  $QT = 2$  units and  $PT = RS = 2$  units.

Now, using the Pythagoras theorem, we have

$$\begin{aligned} PQ^2 &= PT^2 + QT^2 \\ &= 2^2 + 2^2 = 8 \end{aligned}$$

So,  $PQ = 2\sqrt{2}$  units

How will we find the distance between two points in two different quadrants?

Consider the points  $P(6, 4)$  and  $Q(-5, -3)$  (see Fig. 7.4). Draw  $QS$  perpendicular to the  $x$ -axis. Also draw a perpendicular  $PT$  from the point  $P$  on  $QS$  (extended) to meet  $y$ -axis at the point  $R$ .

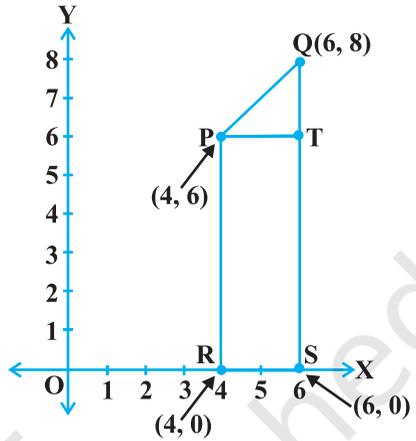


Fig. 7.3

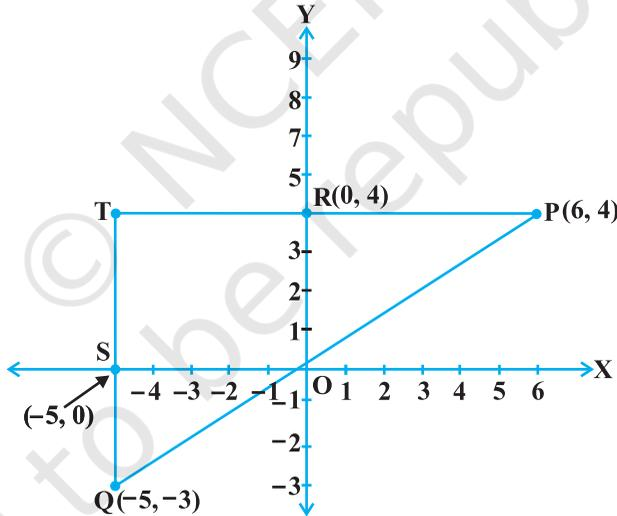


Fig. 7.4

Then  $PT = 11$  units and  $QT = 7$  units. (Why?)

Using the Pythagoras Theorem to the right triangle  $PTQ$ , we get

$$PQ = \sqrt{11^2 + 7^2} = \sqrt{170} \text{ units.}$$

Let us now find the distance between any two points  $P(x_1, y_1)$  and  $Q(x_2, y_2)$ . Draw  $PR$  and  $QS$  perpendicular to the  $x$ -axis. A perpendicular from the point  $P$  on  $QS$  is drawn to meet it at the point  $T$  (see Fig. 7.5).

Then,  $OR = x_1$ ,  $OS = x_2$ . So,  $RS = x_2 - x_1 = PT$ .

Also,  $SQ = y_2$ ,  $ST = PR = y_1$ . So,  $QT = y_2 - y_1$ .

Now, applying the Pythagoras theorem in  $\Delta PTQ$ , we get

$$\begin{aligned} PQ^2 &= PT^2 + QT^2 \\ &= (x_2 - x_1)^2 + (y_2 - y_1)^2 \end{aligned}$$

Therefore,  $PQ = \sqrt{(x_2 - x_1)^2 + (y_2 - y_1)^2}$

Note that since distance is always non-negative, we take only the positive square root. So, the distance between the points  $P(x_1, y_1)$  and  $Q(x_2, y_2)$  is

$$PQ = \sqrt{(x_2 - x_1)^2 + (y_2 - y_1)^2},$$

which is called the **distance formula**.

#### Remarks :

1. In particular, the distance of a point  $P(x, y)$  from the origin  $O(0, 0)$  is given by

$$OP = \sqrt{x^2 + y^2}.$$

2. We can also write,  $PQ = \sqrt{(x_1 - x_2)^2 + (y_1 - y_2)^2}$ . (Why?)

**Example 1 :** Do the points  $(3, 2)$ ,  $(-2, -3)$  and  $(2, 3)$  form a triangle? If so, name the type of triangle formed.

**Solution :** Let us apply the distance formula to find the distances  $PQ$ ,  $QR$  and  $PR$ , where  $P(3, 2)$ ,  $Q(-2, -3)$  and  $R(2, 3)$  are the given points. We have

$$PQ = \sqrt{(3+2)^2 + (2+3)^2} = \sqrt{5^2 + 5^2} = \sqrt{50} = 7.07 \text{ (approx.)}$$

$$QR = \sqrt{(-2-2)^2 + (-3-3)^2} = \sqrt{(-4)^2 + (-6)^2} = \sqrt{52} = 7.21 \text{ (approx.)}$$

$$PR = \sqrt{(3-2)^2 + (2-3)^2} = \sqrt{1^2 + (-1)^2} = \sqrt{2} = 1.41 \text{ (approx.)}$$

Since the sum of any two of these distances is greater than the third distance, therefore, the points  $P$ ,  $Q$  and  $R$  form a triangle.

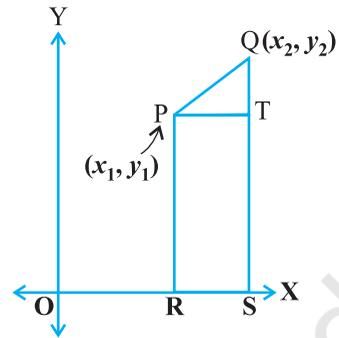


Fig. 7.5

Also,  $PQ^2 + PR^2 = QR^2$ , by the converse of Pythagoras theorem, we have  $\angle P = 90^\circ$ . Therefore, PQR is a right triangle.

**Example 2 :** Show that the points (1, 7), (4, 2), (-1, -1) and (-4, 4) are the vertices of a square.

**Solution :** Let A(1, 7), B(4, 2), C(-1, -1) and D(-4, 4) be the given points. One way of showing that ABCD is a square is to use the property that all its sides should be equal and both its diagonals should also be equal. Now,

$$AB = \sqrt{(1 - 4)^2 + (7 - 2)^2} = \sqrt{9 + 25} = \sqrt{34}$$

$$BC = \sqrt{(4 + 1)^2 + (2 + 1)^2} = \sqrt{25 + 9} = \sqrt{34}$$

$$CD = \sqrt{(-1 + 4)^2 + (-1 - 4)^2} = \sqrt{9 + 25} = \sqrt{34}$$

$$DA = \sqrt{(1 + 4)^2 + (7 - 4)^2} = \sqrt{25 + 9} = \sqrt{34}$$

$$AC = \sqrt{(1 + 1)^2 + (7 + 1)^2} = \sqrt{4 + 64} = \sqrt{68}$$

$$BD = \sqrt{(4 + 4)^2 + (2 - 4)^2} = \sqrt{64 + 4} = \sqrt{68}$$

Since,  $AB = BC = CD = DA$  and  $AC = BD$ , all the four sides of the quadrilateral ABCD are equal and its diagonals AC and BD are also equal. Therefore, ABCD is a square.

**Alternative Solution :** We find the four sides and one diagonal, say, AC as above. Here  $AD^2 + DC^2 = 34 + 34 = 68 = AC^2$ . Therefore, by the converse of Pythagoras theorem,  $\angle D = 90^\circ$ . A quadrilateral with all four sides equal and one angle  $90^\circ$  is a square. So, ABCD is a square.

**Example 3 :** Fig. 7.6 shows the arrangement of desks in a classroom. Ashima, Bharti and Camella are seated at A(3, 1), B(6, 4) and C(8, 6) respectively. Do you think they are seated in a line? Give reasons for your answer.

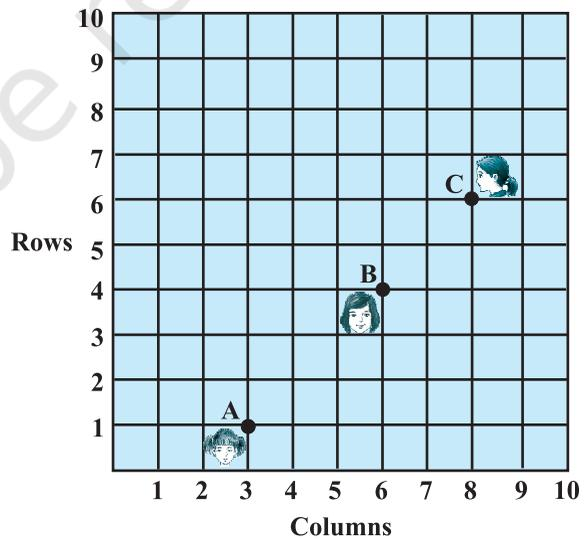


Fig. 7.6

**Solution :** Using the distance formula, we have

$$AB = \sqrt{(6-3)^2 + (4-1)^2} = \sqrt{9+9} = \sqrt{18} = 3\sqrt{2}$$

$$BC = \sqrt{(8-6)^2 + (6-4)^2} = \sqrt{4+4} = \sqrt{8} = 2\sqrt{2}$$

$$AC = \sqrt{(8-3)^2 + (6-1)^2} = \sqrt{25+25} = \sqrt{50} = 5\sqrt{2}$$

Since,  $AB + BC = 3\sqrt{2} + 2\sqrt{2} = 5\sqrt{2} = AC$ , we can say that the points A, B and C are collinear. Therefore, they are seated in a line.

**Example 4 :** Find a relation between  $x$  and  $y$  such that the point  $(x, y)$  is equidistant from the points  $(7, 1)$  and  $(3, 5)$ .

**Solution :** Let  $P(x, y)$  be equidistant from the points  $A(7, 1)$  and  $B(3, 5)$ .

We are given that  $AP = BP$ . So,  $AP^2 = BP^2$

$$\text{i.e.,} \quad (x-7)^2 + (y-1)^2 = (x-3)^2 + (y-5)^2$$

$$\text{i.e.,} \quad x^2 - 14x + 49 + y^2 - 2y + 1 = x^2 - 6x + 9 + y^2 - 10y + 25$$

$$\text{i.e.,} \quad x - y = 2$$

which is the required relation.

**Remark :** Note that the graph of the equation  $x - y = 2$  is a line. From your earlier studies, you know that a point which is equidistant from A and B lies on the perpendicular bisector of AB. Therefore, the graph of  $x - y = 2$  is the perpendicular bisector of AB (see Fig. 7.7).

**Example 5 :** Find a point on the  $y$ -axis which is equidistant from the points  $A(6, 5)$  and  $B(-4, 3)$ .

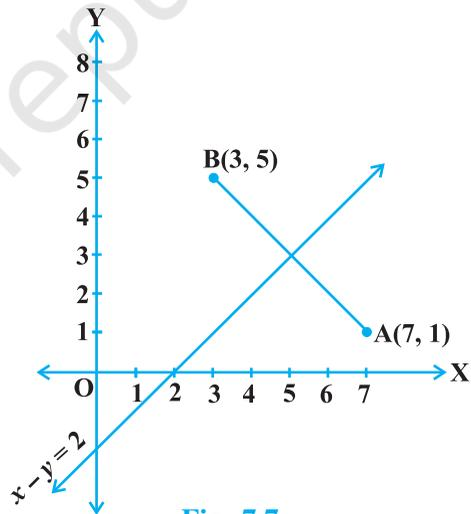
**Solution :** We know that a point on the  $y$ -axis is of the form  $(0, y)$ . So, let the point  $P(0, y)$  be equidistant from A and B. Then

$$(6-0)^2 + (5-y)^2 = (-4-0)^2 + (3-y)^2$$

$$\text{i.e.,} \quad 36 + 25 + y^2 - 10y = 16 + 9 + y^2 - 6y$$

$$\text{i.e.,} \quad 4y = 36$$

$$\text{i.e.,} \quad y = 9$$



**Fig. 7.7**

So, the required point is (0, 9).

Let us check our solution :  $AP = \sqrt{(6 - 0)^2 + (5 - 9)^2} = \sqrt{36 + 16} = \sqrt{52}$

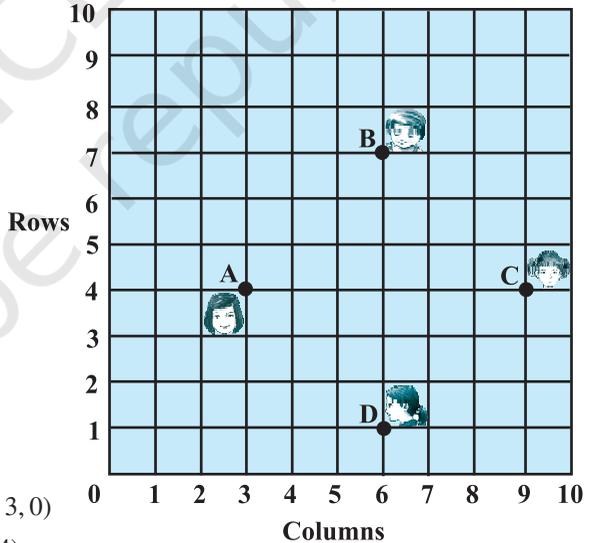
$$BP = \sqrt{(-4 - 0)^2 + (3 - 9)^2} = \sqrt{16 + 36} = \sqrt{52}$$

**Note :** Using the remark above, we see that (0, 9) is the intersection of the y-axis and the perpendicular bisector of AB.

**EXERCISE 7.1**

- Find the distance between the following pairs of points :  
 (i) (2, 3), (4, 1)      (ii) (-5, 7), (-1, 3)      (iii) (a, b), (-a, -b)
- Find the distance between the points (0, 0) and (36, 15). Can you now find the distance between the two towns A and B discussed in Section 7.2.
- Determine if the points (1, 5), (2, 3) and (-2, -11) are collinear.
- Check whether (5, -2), (6, 4) and (7, -2) are the vertices of an isosceles triangle.

5. In a classroom, 4 friends are seated at the points A, B, C and D as shown in Fig. 7.8. Champa and Chameli walk into the class and after observing for a few minutes Champa asks Chameli, “Don’t you think ABCD is a square?” Chameli disagrees. Using distance formula, find which of them is correct.



**Fig. 7.8**

- Name the type of quadrilateral formed, if any, by the following points, and give reasons for your answer:  
 (i) (-1, -2), (1, 0), (-1, 2), (-3, 0)  
 (ii) (-3, 5), (3, 1), (0, 3), (-1, -4)  
 (iii) (4, 5), (7, 6), (4, 3), (1, 2)
- Find the point on the x-axis which is equidistant from (2, -5) and (-2, 9).
- Find the values of y for which the distance between the points P(2, -3) and Q(10, y) is 10 units.

9. If  $Q(0, 1)$  is equidistant from  $P(5, -3)$  and  $R(x, 6)$ , find the values of  $x$ . Also find the distances  $QR$  and  $PR$ .
10. Find a relation between  $x$  and  $y$  such that the point  $(x, y)$  is equidistant from the point  $(3, 6)$  and  $(-3, 4)$ .

### 7.3 Section Formula

Let us recall the situation in Section 7.2. Suppose a telephone company wants to position a relay tower at  $P$  between  $A$  and  $B$  is such a way that the distance of the tower from  $B$  is twice its distance from  $A$ . If  $P$  lies on  $AB$ , it will divide  $AB$  in the ratio  $1 : 2$  (see Fig. 7.9). If we take  $A$  as the origin  $O$ , and 1 km as one unit on both the axis, the coordinates of  $B$  will be  $(36, 15)$ . In order to know the position of the tower, we must know the coordinates of  $P$ . How do we find these coordinates?

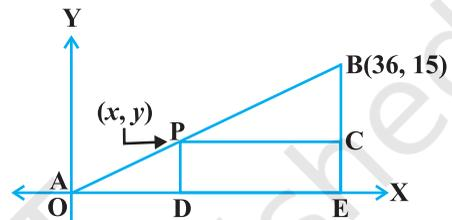


Fig. 7.9

Let the coordinates of  $P$  be  $(x, y)$ . Draw perpendiculars from  $P$  and  $B$  to the  $x$ -axis, meeting it in  $D$  and  $E$ , respectively. Draw  $PC$  perpendicular to  $BE$ . Then, by the AA similarity criterion, studied in Chapter 6,  $\triangle POD$  and  $\triangle BPC$  are similar.

Therefore,  $\frac{OD}{PC} = \frac{OP}{PB} = \frac{1}{2}$ , and  $\frac{PD}{BC} = \frac{OP}{PB} = \frac{1}{2}$

So,  $\frac{x}{36-x} = \frac{1}{2}$  and  $\frac{y}{15-y} = \frac{1}{2}$ .

These equations give  $x = 12$  and  $y = 5$ .

You can check that  $P(12, 5)$  meets the condition that  $OP : PB = 1 : 2$ .

Now let us use the understanding that you may have developed through this example to obtain the general formula.

Consider any two points  $A(x_1, y_1)$  and  $B(x_2, y_2)$  and assume that  $P(x, y)$  divides  $AB$  internally in the ratio  $m_1 : m_2$ , i.e.,

$$\frac{PA}{PB} = \frac{m_1}{m_2} \quad (\text{see Fig. 7.10}).$$

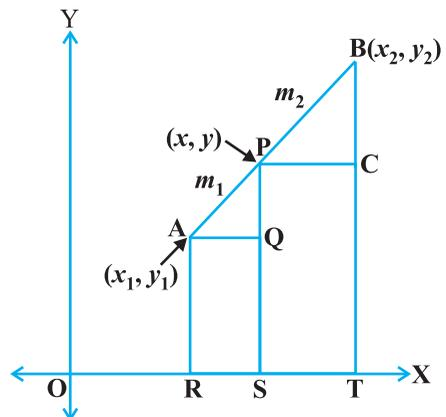


Fig. 7.10

Draw AR, PS and BT perpendicular to the  $x$ -axis. Draw AQ and PC parallel to the  $x$ -axis. Then, by the AA similarity criterion,

$$\Delta PAQ \sim \Delta BPC$$

Therefore, 
$$\frac{PA}{BP} = \frac{AQ}{PC} = \frac{PQ}{BC} \quad (1)$$

Now, 
$$\begin{aligned} AQ &= RS = OS - OR = x - x_1 \\ PC &= ST = OT - OS = x_2 - x \\ PQ &= PS - QS = PS - AR = y - y_1 \\ BC &= BT - CT = BT - PS = y_2 - y \end{aligned}$$

Substituting these values in (1), we get

$$\frac{m_1}{m_2} = \frac{x - x_1}{x_2 - x} = \frac{y - y_1}{y_2 - y}$$

Taking 
$$\frac{m_1}{m_2} = \frac{x - x_1}{x_2 - x}, \text{ we get } x = \frac{m_1 x_2 + m_2 x_1}{m_1 + m_2}$$

Similarly, taking 
$$\frac{m_1}{m_2} = \frac{y - y_1}{y_2 - y}, \text{ we get } y = \frac{m_1 y_2 + m_2 y_1}{m_1 + m_2}$$

So, the coordinates of the point  $P(x, y)$  which divides the line segment joining the points  $A(x_1, y_1)$  and  $B(x_2, y_2)$ , internally, in the ratio  $m_1 : m_2$  are

$$\left( \frac{m_1 x_2 + m_2 x_1}{m_1 + m_2}, \frac{m_1 y_2 + m_2 y_1}{m_1 + m_2} \right) \quad (2)$$

This is known as the **section formula**.

This can also be derived by drawing perpendiculars from A, P and B on the  $y$ -axis and proceeding as above.

If the ratio in which P divides AB is  $k : 1$ , then the coordinates of the point P will be

$$\left( \frac{kx_2 + x_1}{k + 1}, \frac{ky_2 + y_1}{k + 1} \right).$$

**Special Case :** The mid-point of a line segment divides the line segment in the ratio  $1 : 1$ . Therefore, the coordinates of the mid-point P of the join of the points  $A(x_1, y_1)$  and  $B(x_2, y_2)$  is

$$\left( \frac{1 \cdot x_1 + 1 \cdot x_2}{1 + 1}, \frac{1 \cdot y_1 + 1 \cdot y_2}{1 + 1} \right) = \left( \frac{x_1 + x_2}{2}, \frac{y_1 + y_2}{2} \right).$$

Let us solve a few examples based on the section formula.

**Example 6 :** Find the coordinates of the point which divides the line segment joining the points  $(4, -3)$  and  $(8, 5)$  in the ratio  $3 : 1$  internally.

**Solution :** Let  $P(x, y)$  be the required point. Using the section formula, we get

$$x = \frac{3(8) + 1(4)}{3 + 1} = 7, \quad y = \frac{3(5) + 1(-3)}{3 + 1} = 3$$

Therefore,  $(7, 3)$  is the required point.

**Example 7 :** In what ratio does the point  $(-4, 6)$  divide the line segment joining the points  $A(-6, 10)$  and  $B(3, -8)$ ?

**Solution :** Let  $(-4, 6)$  divide  $AB$  internally in the ratio  $m_1 : m_2$ . Using the section formula, we get

$$(-4, 6) = \left( \frac{3m_1 - 6m_2}{m_1 + m_2}, \frac{-8m_1 + 10m_2}{m_1 + m_2} \right) \quad (1)$$

Recall that if  $(x, y) = (a, b)$  then  $x = a$  and  $y = b$ .

So, 
$$-4 = \frac{3m_1 - 6m_2}{m_1 + m_2} \quad \text{and} \quad 6 = \frac{-8m_1 + 10m_2}{m_1 + m_2}$$

Now, 
$$-4 = \frac{3m_1 - 6m_2}{m_1 + m_2} \quad \text{gives us}$$

$$-4m_1 - 4m_2 = 3m_1 - 6m_2$$

i.e., 
$$7m_1 = 2m_2$$

i.e., 
$$m_1 : m_2 = 2 : 7$$

You should verify that the ratio satisfies the  $y$ -coordinate also.

Now, 
$$\frac{-8m_1 + 10m_2}{m_1 + m_2} = \frac{-8 \frac{m_1}{m_2} + 10}{\frac{m_1}{m_2} + 1} \quad (\text{Dividing throughout by } m_2)$$

$$= \frac{-8 \times \frac{2}{7} + 10}{\frac{2}{7} + 1} = 6$$

Therefore, the point  $(-4, 6)$  divides the line segment joining the points  $A(-6, 10)$  and  $B(3, -8)$  in the ratio  $2 : 7$ .

**Alternatively :** The ratio  $m_1 : m_2$  can also be written as  $\frac{m_1}{m_2} : 1$ , or  $k : 1$ . Let  $(-4, 6)$

divide  $AB$  internally in the ratio  $k : 1$ . Using the section formula, we get

$$(-4, 6) = \left( \frac{3k - 6}{k + 1}, \frac{-8k + 10}{k + 1} \right) \quad (2)$$

So, 
$$-4 = \frac{3k - 6}{k + 1}$$

i.e., 
$$-4k - 4 = 3k - 6$$

i.e., 
$$7k = 2$$

i.e., 
$$k : 1 = 2 : 7$$

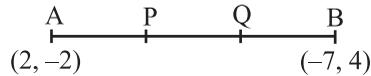
You can check for the  $y$ -coordinate also.

So, the point  $(-4, 6)$  divides the line segment joining the points  $A(-6, 10)$  and  $B(3, -8)$  in the ratio  $2 : 7$ .

**Note :** You can also find this ratio by calculating the distances  $PA$  and  $PB$  and taking their ratios provided you know that  $A, P$  and  $B$  are collinear.

**Example 8 :** Find the coordinates of the points of trisection (i.e., points dividing in three equal parts) of the line segment joining the points  $A(2, -2)$  and  $B(-7, 4)$ .

**Solution :** Let  $P$  and  $Q$  be the points of trisection of  $AB$  i.e.,  $AP = PQ = QB$  (see Fig. 7.11).



**Fig. 7.11**

Therefore,  $P$  divides  $AB$  internally in the ratio  $1 : 2$ . Therefore, the coordinates of  $P$ , by applying the section formula, are

$$\left( \frac{1(-7) + 2(2)}{1 + 2}, \frac{1(4) + 2(-2)}{1 + 2} \right), \text{ i.e., } (-1, 0)$$

Now,  $Q$  also divides  $AB$  internally in the ratio  $2 : 1$ . So, the coordinates of  $Q$  are

$$\left( \frac{2(-7) + 1(2)}{2 + 1}, \frac{2(4) + 1(-2)}{2 + 1} \right), \text{ i.e., } (-4, 2)$$

Therefore, the coordinates of the points of trisection of the line segment joining A and B are  $(-1, 0)$  and  $(-4, 2)$ .

**Note :** We could also have obtained Q by noting that it is the mid-point of PB. So, we could have obtained its coordinates using the mid-point formula.

**Example 9 :** Find the ratio in which the y-axis divides the line segment joining the points  $(5, -6)$  and  $(-1, -4)$ . Also find the point of intersection.

**Solution :** Let the ratio be  $k : 1$ . Then by the section formula, the coordinates of the point which divides AB in the ratio  $k : 1$  are  $\left(\frac{-k + 5}{k + 1}, \frac{-4k - 6}{k + 1}\right)$ .

This point lies on the y-axis, and we know that on the y-axis the abscissa is 0.

Therefore, 
$$\frac{-k + 5}{k + 1} = 0$$

So, 
$$k = 5$$

That is, the ratio is  $5 : 1$ . Putting the value of  $k = 5$ , we get the point of intersection as

$$\left(0, \frac{-13}{3}\right).$$

**Example 10 :** If the points A(6, 1), B(8, 2), C(9, 4) and D( $p$ , 3) are the vertices of a parallelogram, taken in order, find the value of  $p$ .

**Solution :** We know that diagonals of a parallelogram bisect each other.

So, the coordinates of the mid-point of AC = coordinates of the mid-point of BD

i.e., 
$$\left(\frac{6 + 9}{2}, \frac{1 + 4}{2}\right) = \left(\frac{8 + p}{2}, \frac{2 + 3}{2}\right)$$

i.e., 
$$\left(\frac{15}{2}, \frac{5}{2}\right) = \left(\frac{8 + p}{2}, \frac{5}{2}\right)$$

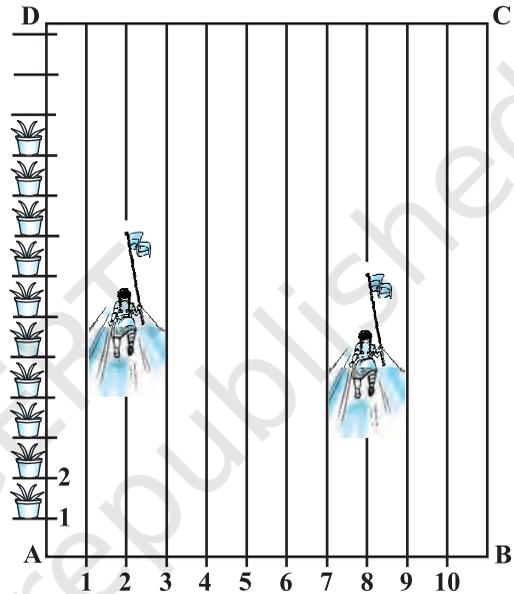
so, 
$$\frac{15}{2} = \frac{8 + p}{2}$$

i.e., 
$$p = 7$$

**EXERCISE 7.2**

1. Find the coordinates of the point which divides the join of  $(-1, 7)$  and  $(4, -3)$  in the ratio  $2 : 3$ .
2. Find the coordinates of the points of trisection of the line segment joining  $(4, -1)$  and  $(-2, -3)$ .

3. To conduct Sports Day activities, in your rectangular shaped school ground ABCD, lines have been drawn with chalk powder at a distance of 1m each. 100 flower pots have been placed at a distance of 1m from each other along AD, as shown in Fig. 7.12. Niharika runs  $\frac{1}{4}$  th the distance AD on the 2nd line and posts a green flag. Preet runs  $\frac{1}{5}$  th the distance AD on the eighth line and posts a red flag. What is the distance between both the flags? If Rashmi has to post a blue flag exactly halfway between the line segment joining the two flags, where should she post her flag?



**Fig. 7.12**

4. Find the ratio in which the line segment joining the points  $(-3, 10)$  and  $(6, -8)$  is divided by  $(-1, 6)$ .
5. Find the ratio in which the line segment joining  $A(1, -5)$  and  $B(-4, 5)$  is divided by the  $x$ -axis. Also find the coordinates of the point of division.
6. If  $(1, 2)$ ,  $(4, y)$ ,  $(x, 6)$  and  $(3, 5)$  are the vertices of a parallelogram taken in order, find  $x$  and  $y$ .
7. Find the coordinates of a point A, where AB is the diameter of a circle whose centre is  $(2, -3)$  and B is  $(1, 4)$ .
8. If A and B are  $(-2, -2)$  and  $(2, -4)$ , respectively, find the coordinates of P such that  $AP = \frac{3}{7} AB$  and P lies on the line segment AB.
9. Find the coordinates of the points which divide the line segment joining  $A(-2, 2)$  and  $B(2, 8)$  into four equal parts.
10. Find the area of a rhombus if its vertices are  $(3, 0)$ ,  $(4, 5)$ ,  $(-1, 4)$  and  $(-2, -1)$  taken in order. [**Hint** : Area of a rhombus =  $\frac{1}{2}$  (product of its diagonals)]

## 7.4 Area of a Triangle

In your earlier classes, you have studied how to calculate the area of a triangle when its base and corresponding height (altitude) are given. You have used the formula :

$$\text{Area of a triangle} = \frac{1}{2} \times \text{base} \times \text{altitude}$$

In Class IX, you have also studied Heron's formula to find the area of a triangle. Now, if the coordinates of the vertices of a triangle are given, can you find its area? Well, you could find the lengths of the three sides using the distance formula and then use Heron's formula. But this could be tedious, particularly if the lengths of the sides are irrational numbers. Let us see if there is an easier way out.

Let ABC be any triangle whose vertices are  $A(x_1, y_1)$ ,  $B(x_2, y_2)$  and  $C(x_3, y_3)$ . Draw AP, BQ and CR perpendiculars from A, B and C, respectively, to the  $x$ -axis. Clearly ABQP, APRC and BQRC are all trapezia (see Fig. 7.13).

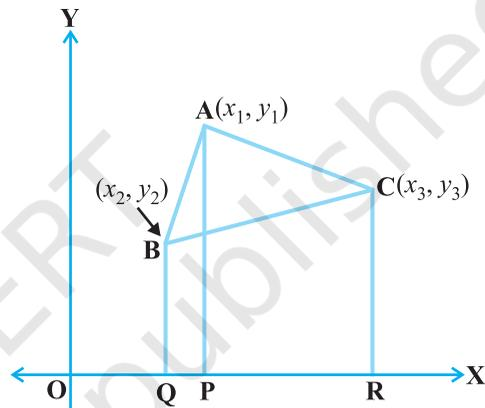


Fig. 7.13

Now, from Fig. 7.13, it is clear that

$$\begin{aligned} \text{area of } \Delta ABC &= \text{area of trapezium ABQP} + \text{area of trapezium APRC} \\ &\quad - \text{area of trapezium BQRC.} \end{aligned}$$

You also know that the

$$\text{area of a trapezium} = \frac{1}{2} (\text{sum of parallel sides})(\text{distance between them})$$

Therefore,

$$\begin{aligned} \text{Area of } \Delta ABC &= \frac{1}{2} (BQ + AP) QP + \frac{1}{2} (AP + CR) PR - \frac{1}{2} (BQ + CR) QR \\ &= \frac{1}{2} (y_2 + y_1)(x_1 - x_2) + \frac{1}{2} (y_1 + y_3)(x_3 - x_1) - \frac{1}{2} (y_2 + y_3)(x_3 - x_2) \\ &= \frac{1}{2} [x_1(y_2 - y_3) + x_2(y_3 - y_1) + x_3(y_1 - y_2)] \end{aligned}$$

Thus, the area of  $\Delta ABC$  is the numerical value of the expression

$$\frac{1}{2} [x_1(y_2 - y_3) + x_2(y_3 - y_1) + x_3(y_1 - y_2)]$$

Let us consider a few examples in which we make use of this formula.

**Example 11 :** Find the area of a triangle whose vertices are (1, -1), (-4, 6) and (-3, -5).

**Solution :** The area of the triangle formed by the vertices A(1, -1), B(-4, 6) and C(-3, -5), by using the formula above, is given by

$$\begin{aligned} & \frac{1}{2} [1(6 + 5) + (-4)(-5 + 1) + (-3)(-1 - 6)] \\ &= \frac{1}{2} (11 + 16 + 21) = 24 \end{aligned}$$

So, the area of the triangle is 24 square units.

**Example 12 :** Find the area of a triangle formed by the points A(5, 2), B(4, 7) and C(7, -4).

**Solution :** The area of the triangle formed by the vertices A(5, 2), B(4, 7) and C(7, -4) is given by

$$\begin{aligned} & \frac{1}{2} [5(7 + 4) + 4(-4 - 2) + 7(2 - 7)] \\ &= \frac{1}{2} (55 - 24 - 35) = \frac{-4}{2} = -2 \end{aligned}$$

Since area is a measure, which cannot be negative, we will take the numerical value of -2, i.e., 2. Therefore, the area of the triangle = 2 square units.

**Example 13 :** Find the area of the triangle formed by the points P(-1.5, 3), Q(6, -2) and R(-3, 4).

**Solution :** The area of the triangle formed by the given points is equal to

$$\begin{aligned} & \frac{1}{2} [-1.5(-2 - 4) + 6(4 - 3) + (-3)(3 + 2)] \\ &= \frac{1}{2} (9 + 6 - 15) = 0 \end{aligned}$$

Can we have a triangle of area 0 square units? What does this mean?

If the area of a triangle is 0 square units, then its vertices will be collinear.

**Example 14 :** Find the value of  $k$  if the points A(2, 3), B(4,  $k$ ) and C(6, -3) are collinear.

**Solution :** Since the given points are collinear, the area of the triangle formed by them must be 0, i.e.,

$$\frac{1}{2}[2(k+3) + 4(-3-3) + 6(3-k)] = 0$$

i.e.,  $\frac{1}{2}(-4k) = 0$

Therefore,  $k = 0$

Let us verify our answer.

$$\text{area of } \Delta ABC = \frac{1}{2}[2(0+3) + 4(-3-3) + 6(3-0)] = 0$$

**Example 15 :** If A(-5, 7), B(-4, -5), C(-1, -6) and D(4, 5) are the vertices of a quadrilateral, find the area of the quadrilateral ABCD.

**Solution :** By joining B to D, you will get two triangles ABD and BCD.

Now the area of  $\Delta ABD = \frac{1}{2}[-5(-5-5) + (-4)(5-7) + 4(7+5)]$   
 $= \frac{1}{2}(50 + 8 + 48) = \frac{106}{2} = 53$  square units

Also, the area of  $\Delta BCD = \frac{1}{2}[-4(-6-5) - 1(5+5) + 4(-5+6)]$   
 $= \frac{1}{2}(44 - 10 + 4) = 19$  square units

So, the area of quadrilateral ABCD = 53 + 19 = 72 square units.

**Note :** To find the area of a polygon, we divide it into triangular regions, which have no common area, and add the areas of these regions.

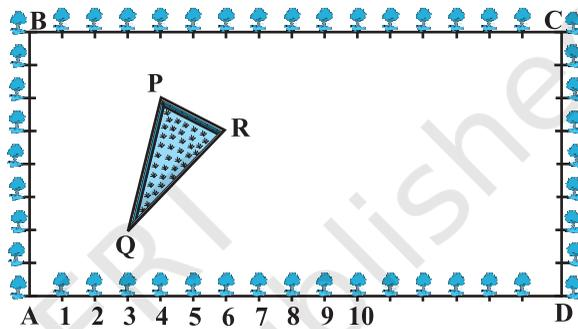
### EXERCISE 7.3

- Find the area of the triangle whose vertices are :  
 (i) (2, 3), (-1, 0), (2, -4)                      (ii) (-5, -1), (3, -5), (5, 2)
- In each of the following find the value of 'k', for which the points are collinear.  
 (i) (7, -2), (5, 1), (3, k)                      (ii) (8, 1), (k, -4), (2, -5)
- Find the area of the triangle formed by joining the mid-points of the sides of the triangle whose vertices are (0, -1), (2, 1) and (0, 3). Find the ratio of this area to the area of the given triangle.
- Find the area of the quadrilateral whose vertices, taken in order, are (-4, -2), (-3, -5), (3, -2) and (2, 3).
- You have studied in Class IX, (Chapter 9, Example 3), that a median of a triangle divides it into two triangles of equal areas. Verify this result for  $\Delta ABC$  whose vertices are A(4, -6), B(3, -2) and C(5, 2).

**EXERCISE 7.4 (Optional)\***

1. Determine the ratio in which the line  $2x + y - 4 = 0$  divides the line segment joining the points  $A(2, -2)$  and  $B(3, 7)$ .
2. Find a relation between  $x$  and  $y$  if the points  $(x, y)$ ,  $(1, 2)$  and  $(7, 0)$  are collinear.
3. Find the centre of a circle passing through the points  $(6, -6)$ ,  $(3, -7)$  and  $(3, 3)$ .
4. The two opposite vertices of a square are  $(-1, 2)$  and  $(3, 2)$ . Find the coordinates of the other two vertices.
5. The Class X students of a

secondary school in Krishinagar have been allotted a rectangular plot of land for their gardening activity. Sapling of Gulmohar are planted on the boundary at a distance of 1m from each other. There is a triangular grassy lawn in the plot as shown in the Fig. 7.14. The students are to sow seeds of flowering plants on the remaining area of the plot.



**Fig. 7.14**

- (i) Taking A as origin, find the coordinates of the vertices of the triangle.
- (ii) What will be the coordinates of the vertices of  $\Delta PQR$  if C is the origin?  
Also calculate the areas of the triangles in these cases. What do you observe?
6. The vertices of a  $\Delta ABC$  are  $A(4, 6)$ ,  $B(1, 5)$  and  $C(7, 2)$ . A line is drawn to intersect sides AB and AC at D and E respectively, such that  $\frac{AD}{AB} = \frac{AE}{AC} = \frac{1}{4}$ . Calculate the area of the  $\Delta ADE$  and compare it with the area of  $\Delta ABC$ . (Recall Theorem 6.2 and Theorem 6.6).
7. Let  $A(4, 2)$ ,  $B(6, 5)$  and  $C(1, 4)$  be the vertices of  $\Delta ABC$ .
  - (i) The median from A meets BC at D. Find the coordinates of the point D.
  - (ii) Find the coordinates of the point P on AD such that  $AP : PD = 2 : 1$
  - (iii) Find the coordinates of points Q and R on medians BE and CF respectively such that  $BQ : QE = 2 : 1$  and  $CR : RF = 2 : 1$ .
  - (iv) What do you observe?

[**Note :** The point which is common to all the three medians is called the *centroid* and this point divides each median in the ratio 2 : 1.]

\* These exercises are not from the examination point of view.

- (v) If  $A(x_1, y_1)$ ,  $B(x_2, y_2)$  and  $C(x_3, y_3)$  are the vertices of  $\Delta ABC$ , find the coordinates of the centroid of the triangle.
8. ABCD is a rectangle formed by the points  $A(-1, -1)$ ,  $B(-1, 4)$ ,  $C(5, 4)$  and  $D(5, -1)$ . P, Q, R and S are the mid-points of AB, BC, CD and DA respectively. Is the quadrilateral PQRS a square? a rectangle? or a rhombus? Justify your answer.

## 7.5 Summary

In this chapter, you have studied the following points :

1. The distance between  $P(x_1, y_1)$  and  $Q(x_2, y_2)$  is  $\sqrt{(x_2 - x_1)^2 + (y_2 - y_1)^2}$ .
2. The distance of a point  $P(x, y)$  from the origin is  $\sqrt{x^2 + y^2}$ .
3. The coordinates of the point  $P(x, y)$  which divides the line segment joining the points  $A(x_1, y_1)$  and  $B(x_2, y_2)$  internally in the ratio  $m_1 : m_2$  are  $\left( \frac{m_1x_2 + m_2x_1}{m_1 + m_2}, \frac{m_1y_2 + m_2y_1}{m_1 + m_2} \right)$ .
4. The mid-point of the line segment joining the points  $P(x_1, y_1)$  and  $Q(x_2, y_2)$  is  $\left( \frac{x_1 + x_2}{2}, \frac{y_1 + y_2}{2} \right)$ .
5. The area of the triangle formed by the points  $(x_1, y_1)$ ,  $(x_2, y_2)$  and  $(x_3, y_3)$  is the numerical value of the expression

$$\frac{1}{2} [x_1(y_2 - y_3) + x_2(y_3 - y_1) + x_3(y_1 - y_2)].$$

### A NOTE TO THE READER

Section 7.3 discusses the Section Formula for the coordinates  $(x, y)$  of a point P which divides internally the line segment joining the points  $A(x_1, y_1)$  and  $B(x_2, y_2)$  in the ratio  $m_1 : m_2$  as follows :

$$x = \frac{m_1x_2 + m_2x_1}{m_1 + m_2}, \quad y = \frac{m_1y_2 + m_2y_1}{m_1 + m_2}$$

Note that, here,  $PA : PB = m_1 : m_2$ .

However, if P does not lie between A and B but lies on the line AB, outside the line segment AB, and  $PA : PB = m_1 : m_2$ , we say that P divides externally the line segment joining the points A and B. You will study Section Formula for such case in higher classes.



1062CH08

# INTRODUCTION TO TRIGONOMETRY

# 8

*There is perhaps nothing which so occupies the middle position of mathematics as trigonometry.*

– J.F. Herbart (1890)

## 8.1 Introduction

You have already studied about triangles, and in particular, right triangles, in your earlier classes. Let us take some examples from our surroundings where right triangles can be imagined to be formed. For instance :

1. Suppose the students of a school are visiting Qutub Minar. Now, if a student is looking at the top of the Minar, a right triangle can be imagined to be made, as shown in Fig 8.1. Can the student find out the height of the Minar, without actually measuring it?

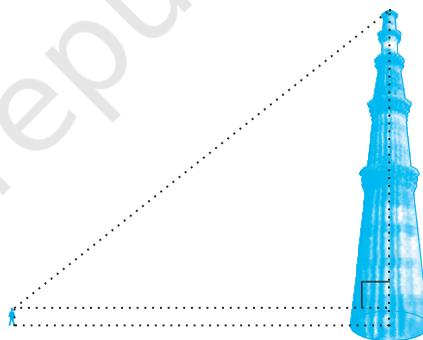


Fig. 8.1

2. Suppose a girl is sitting on the balcony of her house located on the bank of a river. She is looking down at a flower pot placed on a stair of a temple situated nearby on the other bank of the river. A right triangle is imagined to be made in this situation as shown in Fig.8.2. If you know the height at which the person is sitting, can you find the width of the river?

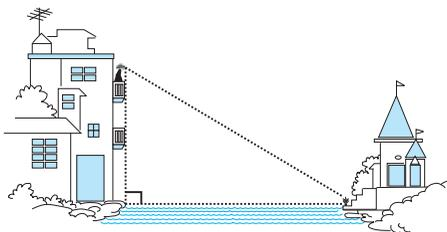


Fig. 8.2

3. Suppose a hot air balloon is flying in the air. A girl happens to spot the balloon in the sky and runs to her mother to tell her about it. Her mother rushes out of the house to look at the balloon. Now when the girl had spotted the balloon initially it was at point A. When both the mother and daughter came out to see it, it had already travelled to another point B. Can you find the altitude of B from the ground?

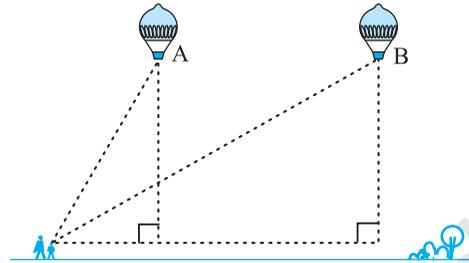


Fig. 8.3

In all the situations given above, the distances or heights can be found by using some mathematical techniques, which come under a branch of mathematics called 'trigonometry'. The word 'trigonometry' is derived from the Greek words 'tri' (meaning three), 'gon' (meaning sides) and 'metron' (meaning measure). In fact, **trigonometry** is the study of relationships between the sides and angles of a triangle. The earliest known work on trigonometry was recorded in Egypt and Babylon. Early astronomers used it to find out the distances of the stars and planets from the Earth. Even today, most of the technologically advanced methods used in Engineering and Physical Sciences are based on trigonometrical concepts.

In this chapter, we will study some ratios of the sides of a right triangle with respect to its acute angles, called **trigonometric ratios of the angle**. We will restrict our discussion to acute angles only. However, these ratios can be extended to other angles also. We will also define the trigonometric ratios for angles of measure  $0^\circ$  and  $90^\circ$ . We will calculate trigonometric ratios for some specific angles and establish some identities involving these ratios, called **trigonometric identities**.

## 8.2 Trigonometric Ratios

In Section 8.1, you have seen some right triangles imagined to be formed in different situations.

Let us take a right triangle ABC as shown in Fig. 8.4.

Here,  $\angle CAB$  (or, in brief, angle A) is an acute angle. Note the position of the side BC with respect to angle A. It faces  $\angle A$ . We call it the *side opposite* to angle A. AC is the *hypotenuse* of the right triangle and the side AB is a part of  $\angle A$ . So, we call it the *side adjacent* to angle A.

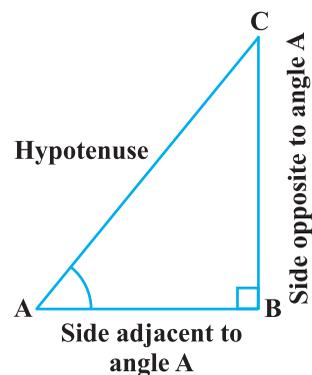


Fig. 8.4

Note that the position of sides change when you consider angle C in place of A (see Fig. 8.5).

You have studied the concept of ‘ratio’ in your earlier classes. We now define certain ratios involving the sides of a right triangle, and call them trigonometric ratios.

**The trigonometric ratios** of the angle A in right triangle ABC (see Fig. 8.4) are defined as follows :

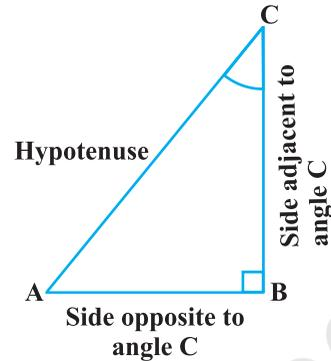


Fig. 8.5

$$\text{sine of } \angle A = \frac{\text{side opposite to angle A}}{\text{hypotenuse}} = \frac{BC}{AC}$$

$$\text{cosine of } \angle A = \frac{\text{side adjacent to angle A}}{\text{hypotenuse}} = \frac{AB}{AC}$$

$$\text{tangent of } \angle A = \frac{\text{side opposite to angle A}}{\text{side adjacent to angle A}} = \frac{BC}{AB}$$

$$\text{cosecant of } \angle A = \frac{1}{\text{sine of } \angle A} = \frac{\text{hypotenuse}}{\text{side opposite to angle A}} = \frac{AC}{BC}$$

$$\text{secant of } \angle A = \frac{1}{\text{cosine of } \angle A} = \frac{\text{hypotenuse}}{\text{side adjacent to angle A}} = \frac{AC}{AB}$$

$$\text{cotangent of } \angle A = \frac{1}{\text{tangent of } \angle A} = \frac{\text{side adjacent to angle A}}{\text{side opposite to angle A}} = \frac{AB}{BC}$$

The ratios defined above are abbreviated as  $\sin A$ ,  $\cos A$ ,  $\tan A$ ,  $\text{cosec } A$ ,  $\sec A$  and  $\cot A$  respectively. Note that the ratios **cosec A**, **sec A** and **cot A** are respectively, the reciprocals of the ratios  $\sin A$ ,  $\cos A$  and  $\tan A$ .

$$\text{Also, observe that } \tan A = \frac{BC}{AB} = \frac{\frac{BC}{AC}}{\frac{AB}{AC}} = \frac{\sin A}{\cos A} \text{ and } \cot A = \frac{\cos A}{\sin A}.$$

So, the **trigonometric ratios** of an acute angle in a right triangle express the relationship between the angle and the length of its sides.

Why don't you try to define the trigonometric ratios for angle C in the right triangle? (See Fig. 8.5)

The first use of the idea of ‘sine’ in the way we use it today was in the work *Aryabhatiyam* by Aryabhata, in A.D. 500. Aryabhata used the word *ardha-jya* for the half-chord, which was shortened to *jya* or *jiva* in due course. When the *Aryabhatiyam* was translated into Arabic, the word *jiva* was retained as it is. The word *jiva* was translated into *sinus*, which means curve, when the Arabic version was translated into Latin. Soon the word *sinus*, also used as *sine*, became common in mathematical texts throughout Europe. An English Professor of astronomy Edmund Gunter (1581–1626), first used the abbreviated notation ‘*sin*’.

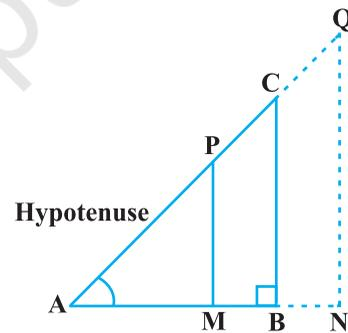


**Aryabhata**  
C.E. 476 – 550

The origin of the terms ‘cosine’ and ‘tangent’ was much later. The cosine function arose from the need to compute the sine of the complementary angle. Aryabhata called it *kotijya*. The name *cosinus* originated with Edmund Gunter. In 1674, the English Mathematician Sir Jonas Moore first used the abbreviated notation ‘*cos*’.

**Remark :** Note that the symbol  $\sin A$  is used as an abbreviation for ‘the sine of the angle  $A$ ’.  $\sin A$  is *not* the product of ‘sin’ and  $A$ . ‘sin’ separated from  $A$  has no meaning. Similarly,  $\cos A$  is *not* the product of ‘cos’ and  $A$ . Similar interpretations follow for other trigonometric ratios also.

Now, if we take a point  $P$  on the hypotenuse  $AC$  or a point  $Q$  on  $AC$  extended, of the right triangle  $ABC$  and draw  $PM$  perpendicular to  $AB$  and  $QN$  perpendicular to  $AB$  extended (see Fig. 8.6), how will the trigonometric ratios of  $\angle A$  in  $\triangle PAM$  differ from those of  $\angle A$  in  $\triangle CAB$  or from those of  $\angle A$  in  $\triangle QAN$ ?



**Fig. 8.6**

To answer this, first look at these triangles. Is  $\triangle PAM$  similar to  $\triangle CAB$ ? From Chapter 6, recall the AA similarity criterion. Using the criterion, you will see that the triangles  $PAM$  and  $CAB$  are similar. Therefore, by the property of similar triangles, the corresponding sides of the triangles are proportional.

So, we have

$$\frac{AM}{AB} = \frac{AP}{AC} = \frac{MP}{BC}.$$

From this, we find  $\frac{MP}{AP} = \frac{BC}{AC} = \sin A$ .

Similarly,  $\frac{AM}{AP} = \frac{AB}{AC} = \cos A$ ,  $\frac{MP}{AM} = \frac{BC}{AB} = \tan A$  and so on.

This shows that the trigonometric ratios of angle A in  $\Delta PAM$  not differ from those of angle A in  $\Delta CAB$ .

In the same way, you should check that the value of  $\sin A$  (and also of other trigonometric ratios) remains the same in  $\Delta QAN$  also.

From our observations, it is now clear that **the values of the trigonometric ratios of an angle do not vary with the lengths of the sides of the triangle, if the angle remains the same.**

**Note :** For the sake of convenience, we may write  $\sin^2 A$ ,  $\cos^2 A$ , etc., in place of  $(\sin A)^2$ ,  $(\cos A)^2$ , etc., respectively. But  $\operatorname{cosec} A = (\sin A)^{-1} \neq \sin^{-1} A$  (it is called sine inverse A).  $\sin^{-1} A$  has a different meaning, which will be discussed in higher classes. Similar conventions hold for the other trigonometric ratios as well. Sometimes, the Greek letter  $\theta$  (theta) is also used to denote an angle.

We have defined six trigonometric ratios of an acute angle. If we know any one of the ratios, can we obtain the other ratios? Let us see.

If in a right triangle ABC,  $\sin A = \frac{1}{3}$ , then this means that  $\frac{BC}{AC} = \frac{1}{3}$ , i.e., the lengths of the sides BC and AC of the triangle ABC are in the ratio 1 : 3 (see Fig. 8.7). So if BC is equal to  $k$ , then AC will be  $3k$ , where  $k$  is any positive number. To determine other

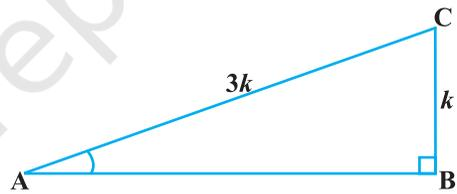


Fig. 8.7

trigonometric ratios for the angle A, we need to find the length of the third side AB. Do you remember the Pythagoras theorem? Let us use it to determine the required length AB.

$$AB^2 = AC^2 - BC^2 = (3k)^2 - (k)^2 = 8k^2 = (2\sqrt{2} k)^2$$

Therefore,  $AB = \pm 2\sqrt{2} k$

So, we get  $AB = 2\sqrt{2} k$  (Why is AB not  $-2\sqrt{2} k$ ?)

Now,  $\cos A = \frac{AB}{AC} = \frac{2\sqrt{2} k}{3k} = \frac{2\sqrt{2}}{3}$

Similarly, you can obtain the other trigonometric ratios of the angle A.

**Remark :** Since the hypotenuse is the longest side in a right triangle, the value of  $\sin A$  or  $\cos A$  is always less than 1 (or, in particular, equal to 1).

Let us consider some examples.

**Example 1 :** Given  $\tan A = \frac{4}{3}$ , find the other trigonometric ratios of the angle  $A$ .

**Solution :** Let us first draw a right  $\Delta ABC$  (see Fig 8.8).

$$\text{Now, we know that } \tan A = \frac{BC}{AB} = \frac{4}{3}.$$

Therefore, if  $BC = 4k$ , then  $AB = 3k$ , where  $k$  is a positive number.

Now, by using the Pythagoras Theorem, we have

$$AC^2 = AB^2 + BC^2 = (4k)^2 + (3k)^2 = 25k^2$$

So,

$$AC = 5k$$

Now, we can write all the trigonometric ratios using their definitions.

$$\sin A = \frac{BC}{AC} = \frac{4k}{5k} = \frac{4}{5}$$

$$\cos A = \frac{AB}{AC} = \frac{3k}{5k} = \frac{3}{5}$$

$$\text{Therefore, } \cot A = \frac{1}{\tan A} = \frac{3}{4}, \text{ cosec } A = \frac{1}{\sin A} = \frac{5}{4} \text{ and } \sec A = \frac{1}{\cos A} = \frac{5}{3}.$$

**Example 2 :** If  $\angle B$  and  $\angle Q$  are acute angles such that  $\sin B = \sin Q$ , then prove that  $\angle B = \angle Q$ .

**Solution :** Let us consider two right triangles  $ABC$  and  $PQR$  where  $\sin B = \sin Q$  (see Fig. 8.9).

We have

$$\sin B = \frac{AC}{AB}$$

and

$$\sin Q = \frac{PR}{PQ}$$

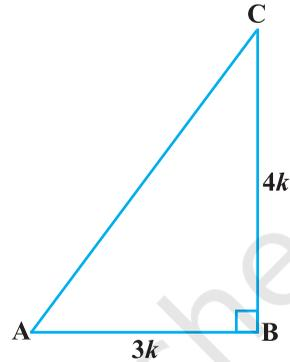


Fig. 8.8

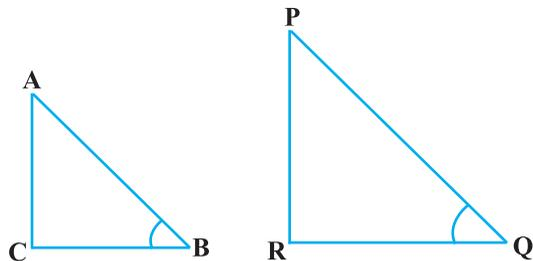


Fig. 8.9

Then 
$$\frac{AC}{AB} = \frac{PR}{PQ}$$

Therefore, 
$$\frac{AC}{PR} = \frac{AB}{PQ} = k, \text{ say} \tag{1}$$

Now, using Pythagoras theorem,

$$BC = \sqrt{AB^2 - AC^2}$$

and

$$QR = \sqrt{PQ^2 - PR^2}$$

So, 
$$\frac{BC}{QR} = \frac{\sqrt{AB^2 - AC^2}}{\sqrt{PQ^2 - PR^2}} = \frac{\sqrt{k^2PQ^2 - k^2PR^2}}{\sqrt{PQ^2 - PR^2}} = k \frac{\sqrt{PQ^2 - PR^2}}{\sqrt{PQ^2 - PR^2}} = k \tag{2}$$

From (1) and (2), we have

$$\frac{AC}{PR} = \frac{AB}{PQ} = \frac{BC}{QR}$$

Then, by using Theorem 6.4,  $\Delta ACB \sim \Delta PRQ$  and therefore,  $\angle B = \angle Q$ .

**Example 3 :** Consider  $\Delta ACB$ , right-angled at C, in which  $AB = 29$  units,  $BC = 21$  units and  $\angle ABC = \theta$  (see Fig. 8.10). Determine the values of

- (i)  $\cos^2 \theta + \sin^2 \theta$ ,
- (ii)  $\cos^2 \theta - \sin^2 \theta$ .

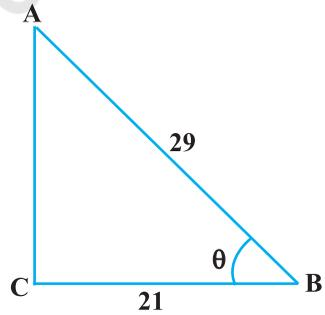
**Solution :** In  $\Delta ACB$ , we have

$$\begin{aligned} AC &= \sqrt{AB^2 - BC^2} = \sqrt{(29)^2 - (21)^2} \\ &= \sqrt{(29 - 21)(29 + 21)} = \sqrt{(8)(50)} = \sqrt{400} = 20 \text{ units} \end{aligned}$$

So, 
$$\sin \theta = \frac{AC}{AB} = \frac{20}{29}, \cos \theta = \frac{BC}{AB} = \frac{21}{29}.$$

Now, (i)  $\cos^2 \theta + \sin^2 \theta = \left(\frac{20}{29}\right)^2 + \left(\frac{21}{29}\right)^2 = \frac{20^2 + 21^2}{29^2} = \frac{400 + 441}{841} = 1,$

and (ii)  $\cos^2 \theta - \sin^2 \theta = \left(\frac{21}{29}\right)^2 - \left(\frac{20}{29}\right)^2 = \frac{(21 + 20)(21 - 20)}{29^2} = \frac{41}{841}.$



**Fig. 8.10**

**Example 4 :** In a right triangle ABC, right-angled at B, if  $\tan A = 1$ , then verify that

$$2 \sin A \cos A = 1.$$

**Solution :** In  $\Delta ABC$ ,  $\tan A = \frac{BC}{AB} = 1$  (see Fig 8.11)

i.e.,  $BC = AB$

Let  $AB = BC = k$ , where  $k$  is a positive number.

Now,

$$\begin{aligned} AC &= \sqrt{AB^2 + BC^2} \\ &= \sqrt{(k)^2 + (k)^2} = k\sqrt{2} \end{aligned}$$

Therefore,

$$\sin A = \frac{BC}{AC} = \frac{1}{\sqrt{2}} \quad \text{and} \quad \cos A = \frac{AB}{AC} = \frac{1}{\sqrt{2}}$$

So,

$$2 \sin A \cos A = 2 \left( \frac{1}{\sqrt{2}} \right) \left( \frac{1}{\sqrt{2}} \right) = 1, \text{ which is the required value.}$$

**Example 5 :** In  $\Delta OPQ$ , right-angled at P,  $OP = 7$  cm and  $OQ - PQ = 1$  cm (see Fig. 8.12). Determine the values of  $\sin Q$  and  $\cos Q$ .

**Solution :** In  $\Delta OPQ$ , we have

$$OQ^2 = OP^2 + PQ^2$$

i.e.,  $(1 + PQ)^2 = OP^2 + PQ^2$  (Why?)

i.e.,  $1 + PQ^2 + 2PQ = OP^2 + PQ^2$

i.e.,  $1 + 2PQ = 7^2$  (Why?)

i.e.,  $PQ = 24$  cm and  $OQ = 1 + PQ = 25$  cm

So,

$$\sin Q = \frac{7}{25} \quad \text{and} \quad \cos Q = \frac{24}{25}$$

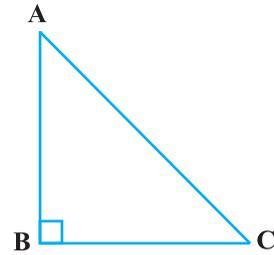


Fig. 8.11

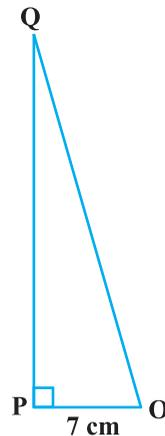


Fig. 8.12

## EXERCISE 8.1

- In  $\triangle ABC$ , right-angled at B,  $AB = 24$  cm,  $BC = 7$  cm. Determine :
  - $\sin A$ ,  $\cos A$
  - $\sin C$ ,  $\cos C$
- In Fig. 8.13, find  $\tan P - \cot R$ .
- If  $\sin A = \frac{3}{4}$ , calculate  $\cos A$  and  $\tan A$ .
- Given  $15 \cot A = 8$ , find  $\sin A$  and  $\sec A$ .
- Given  $\sec \theta = \frac{13}{12}$ , calculate all other trigonometric ratios.
- If  $\angle A$  and  $\angle B$  are acute angles such that  $\cos A = \cos B$ , then show that  $\angle A = \angle B$ .
- If  $\cot \theta = \frac{7}{8}$ , evaluate : (i)  $\frac{(1 + \sin \theta)(1 - \sin \theta)}{(1 + \cos \theta)(1 - \cos \theta)}$ , (ii)  $\cot^2 \theta$
- If  $3 \cot A = 4$ , check whether  $\frac{1 - \tan^2 A}{1 + \tan^2 A} = \cos^2 A - \sin^2 A$  or not.
- In triangle ABC, right-angled at B, if  $\tan A = \frac{1}{\sqrt{3}}$ , find the value of:
  - $\sin A \cos C + \cos A \sin C$
  - $\cos A \cos C - \sin A \sin C$
- In  $\triangle PQR$ , right-angled at Q,  $PR + QR = 25$  cm and  $PQ = 5$  cm. Determine the values of  $\sin P$ ,  $\cos P$  and  $\tan P$ .
- State whether the following are true or false. Justify your answer.
  - The value of  $\tan A$  is always less than 1.
  - $\sec A = \frac{12}{5}$  for some value of angle A.
  - $\cos A$  is the abbreviation used for the cosecant of angle A.
  - $\cot A$  is the product of  $\cot$  and A.
  - $\sin \theta = \frac{4}{3}$  for some angle  $\theta$ .

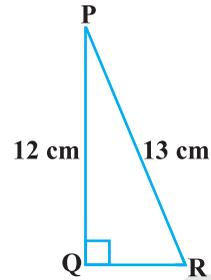


Fig. 8.13

## 8.3 Trigonometric Ratios of Some Specific Angles

From geometry, you are already familiar with the construction of angles of  $30^\circ$ ,  $45^\circ$ ,  $60^\circ$  and  $90^\circ$ . In this section, we will find the values of the trigonometric ratios for these angles and, of course, for  $0^\circ$ .

### Trigonometric Ratios of $45^\circ$

In  $\triangle ABC$ , right-angled at B, if one angle is  $45^\circ$ , then the other angle is also  $45^\circ$ , i.e.,  $\angle A = \angle C = 45^\circ$  (see Fig. 8.14).

So,  $BC = AB$  (Why?)

Now, Suppose  $BC = AB = a$ .

Then by Pythagoras Theorem,  $AC^2 = AB^2 + BC^2 = a^2 + a^2 = 2a^2$ ,

and, therefore,  $AC = a\sqrt{2}$ .

Using the definitions of the trigonometric ratios, we have :

$$\sin 45^\circ = \frac{\text{side opposite to angle } 45^\circ}{\text{hypotenuse}} = \frac{BC}{AC} = \frac{a}{a\sqrt{2}} = \frac{1}{\sqrt{2}}$$

$$\cos 45^\circ = \frac{\text{side adjacent to angle } 45^\circ}{\text{hypotenuse}} = \frac{AB}{AC} = \frac{a}{a\sqrt{2}} = \frac{1}{\sqrt{2}}$$

$$\tan 45^\circ = \frac{\text{side opposite to angle } 45^\circ}{\text{side adjacent to angle } 45^\circ} = \frac{BC}{AB} = \frac{a}{a} = 1$$

$$\text{Also, } \operatorname{cosec} 45^\circ = \frac{1}{\sin 45^\circ} = \sqrt{2}, \sec 45^\circ = \frac{1}{\cos 45^\circ} = \sqrt{2}, \cot 45^\circ = \frac{1}{\tan 45^\circ} = 1.$$

### Trigonometric Ratios of $30^\circ$ and $60^\circ$

Let us now calculate the trigonometric ratios of  $30^\circ$  and  $60^\circ$ . Consider an equilateral triangle ABC. Since each angle in an equilateral triangle is  $60^\circ$ , therefore,  $\angle A = \angle B = \angle C = 60^\circ$ .

Draw the perpendicular AD from A to the side BC (see Fig. 8.15).

Now  $\triangle ABD \cong \triangle ACD$  (Why?)

Therefore,  $BD = DC$

and  $\angle BAD = \angle CAD$  (CPCT)

Now observe that:

$\triangle ABD$  is a right triangle, right-angled at D with  $\angle BAD = 30^\circ$  and  $\angle ABD = 60^\circ$  (see Fig. 8.15).

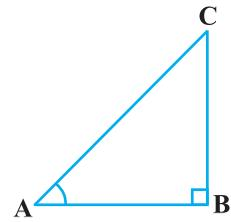


Fig. 8.14

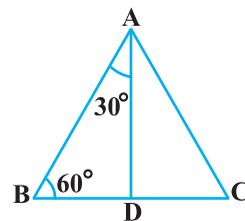


Fig. 8.15

As you know, for finding the trigonometric ratios, we need to know the lengths of the sides of the triangle. So, let us suppose that  $AB = 2a$ .

Then, 
$$BD = \frac{1}{2}BC = a$$

and 
$$AD^2 = AB^2 - BD^2 = (2a)^2 - (a)^2 = 3a^2,$$

Therefore, 
$$AD = a\sqrt{3}$$

Now, we have :

$$\sin 30^\circ = \frac{BD}{AB} = \frac{a}{2a} = \frac{1}{2}, \cos 30^\circ = \frac{AD}{AB} = \frac{a\sqrt{3}}{2a} = \frac{\sqrt{3}}{2}$$

$$\tan 30^\circ = \frac{BD}{AD} = \frac{a}{a\sqrt{3}} = \frac{1}{\sqrt{3}}$$

Also, 
$$\operatorname{cosec} 30^\circ = \frac{1}{\sin 30^\circ} = 2, \sec 30^\circ = \frac{1}{\cos 30^\circ} = \frac{2}{\sqrt{3}}$$

$$\cot 30^\circ = \frac{1}{\tan 30^\circ} = \sqrt{3}.$$

Similarly,

$$\sin 60^\circ = \frac{AD}{AB} = \frac{a\sqrt{3}}{2a} = \frac{\sqrt{3}}{2}, \cos 60^\circ = \frac{1}{2}, \tan 60^\circ = \sqrt{3},$$

$$\operatorname{cosec} 60^\circ = \frac{2}{\sqrt{3}}, \sec 60^\circ = 2 \text{ and } \cot 60^\circ = \frac{1}{\sqrt{3}}.$$

**Trigonometric Ratios of 0° and 90°**

Let us see what happens to the trigonometric ratios of angle A, if it is made smaller and smaller in the right triangle ABC (see Fig. 8.16), till it becomes zero. As  $\angle A$  gets smaller and smaller, the length of the side BC decreases. The point C gets closer to point B, and finally when  $\angle A$  becomes very close to 0°, AC becomes almost the same as AB (see Fig. 8.17).

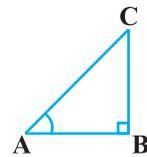


Fig. 8.16

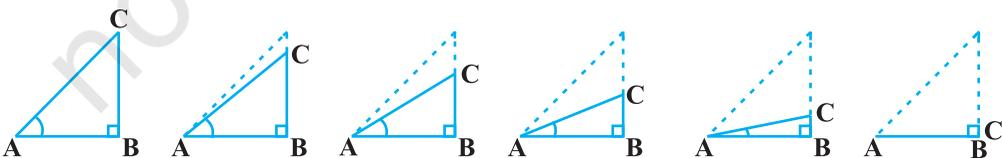


Fig. 8.17

When  $\angle A$  is very close to  $0^\circ$ ,  $BC$  gets very close to 0 and so the value of  $\sin A = \frac{BC}{AC}$  is very close to 0. Also, when  $\angle A$  is very close to  $0^\circ$ ,  $AC$  is nearly the same as  $AB$  and so the value of  $\cos A = \frac{AB}{AC}$  is very close to 1.

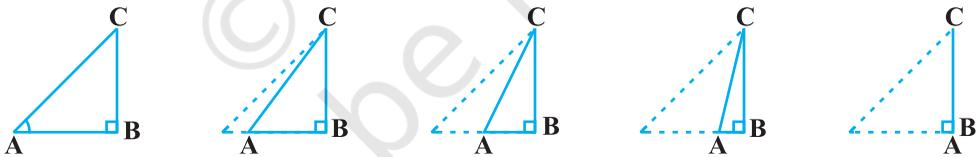
This helps us to see how we can define the values of  $\sin A$  and  $\cos A$  when  $A = 0^\circ$ . We define :  **$\sin 0^\circ = 0$  and  $\cos 0^\circ = 1$** .

Using these, we have :

$$\tan 0^\circ = \frac{\sin 0^\circ}{\cos 0^\circ} = 0, \cot 0^\circ = \frac{1}{\tan 0^\circ}, \text{ which is not defined. (Why?)}$$

$$\sec 0^\circ = \frac{1}{\cos 0^\circ} = 1 \text{ and } \operatorname{cosec} 0^\circ = \frac{1}{\sin 0^\circ}, \text{ which is again not defined. (Why?)}$$

Now, let us see what happens to the trigonometric ratios of  $\angle A$ , when it is made larger and larger in  $\triangle ABC$  till it becomes  $90^\circ$ . As  $\angle A$  gets larger and larger,  $\angle C$  gets smaller and smaller. Therefore, as in the case above, the length of the side  $AB$  goes on decreasing. The point  $A$  gets closer to point  $B$ . Finally when  $\angle A$  is very close to  $90^\circ$ ,  $\angle C$  becomes very close to  $0^\circ$  and the side  $AC$  almost coincides with side  $BC$  (see Fig. 8.18).



**Fig. 8.18**

When  $\angle C$  is very close to  $0^\circ$ ,  $\angle A$  is very close to  $90^\circ$ , side  $AC$  is nearly the same as side  $BC$ , and so  $\sin A$  is very close to 1. Also when  $\angle A$  is very close to  $90^\circ$ ,  $\angle C$  is very close to  $0^\circ$ , and the side  $AB$  is nearly zero, so  $\cos A$  is very close to 0.

So, we define :  **$\sin 90^\circ = 1$  and  $\cos 90^\circ = 0$** .

Now, why don't you find the other trigonometric ratios of  $90^\circ$ ?

We shall now give the values of all the trigonometric ratios of  $0^\circ$ ,  $30^\circ$ ,  $45^\circ$ ,  $60^\circ$  and  $90^\circ$  in Table 8.1, for ready reference.

Table 8.1

$\angle A$	$0^\circ$	$30^\circ$	$45^\circ$	$60^\circ$	$90^\circ$
sin A	0	$\frac{1}{2}$	$\frac{1}{\sqrt{2}}$	$\frac{\sqrt{3}}{2}$	1
cos A	1	$\frac{\sqrt{3}}{2}$	$\frac{1}{\sqrt{2}}$	$\frac{1}{2}$	0
tan A	0	$\frac{1}{\sqrt{3}}$	1	$\sqrt{3}$	Not defined
cosec A	Not defined	2	$\sqrt{2}$	$\frac{2}{\sqrt{3}}$	1
sec A	1	$\frac{2}{\sqrt{3}}$	$\sqrt{2}$	2	Not defined
cot A	Not defined	$\sqrt{3}$	1	$\frac{1}{\sqrt{3}}$	0

**Remark :** From the table above you can observe that as  $\angle A$  increases from  $0^\circ$  to  $90^\circ$ , sin A increases from 0 to 1 and cos A decreases from 1 to 0.

Let us illustrate the use of the values in the table above through some examples.

**Example 6 :** In  $\Delta ABC$ , right-angled at B,  $AB = 5$  cm and  $\angle ACB = 30^\circ$  (see Fig. 8.19). Determine the lengths of the sides BC and AC.

**Solution :** To find the length of the side BC, we will choose the trigonometric ratio involving BC and the given side AB. Since BC is the side adjacent to angle C and AB is the side opposite to angle C, therefore

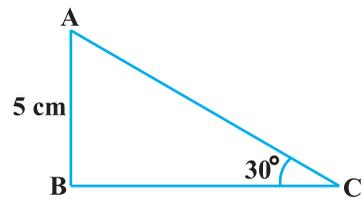


Fig. 8.19

$$\frac{AB}{BC} = \tan C$$

i.e., 
$$\frac{5}{BC} = \tan 30^\circ = \frac{1}{\sqrt{3}}$$

which gives 
$$BC = 5\sqrt{3} \text{ cm}$$

To find the length of the side AC, we consider

$$\sin 30^\circ = \frac{AB}{AC} \quad (\text{Why?})$$

$$\text{i.e.,} \quad \frac{1}{2} = \frac{5}{AC}$$

$$\text{i.e.,} \quad AC = 10 \text{ cm}$$

Note that alternatively we could have used Pythagoras theorem to determine the third side in the example above,

$$\text{i.e.,} \quad AC = \sqrt{AB^2 + BC^2} = \sqrt{5^2 + (5\sqrt{3})^2} \text{ cm} = 10 \text{ cm.}$$

**Example 7 :** In  $\Delta PQR$ , right-angled at Q (see Fig. 8.20),  $PQ = 3 \text{ cm}$  and  $PR = 6 \text{ cm}$ . Determine  $\angle QPR$  and  $\angle PRQ$ .

**Solution :** Given  $PQ = 3 \text{ cm}$  and  $PR = 6 \text{ cm}$ .

Therefore,

$$\frac{PQ}{PR} = \sin R$$

or

$$\sin R = \frac{3}{6} = \frac{1}{2}$$

So,

$$\angle PRQ = 30^\circ$$

and therefore,

$$\angle QPR = 60^\circ. \quad (\text{Why?})$$

You may note that if one of the sides and any other part (either an acute angle or any side) of a right triangle is known, the remaining sides and angles of the triangle can be determined.

**Example 8 :** If  $\sin (A - B) = \frac{1}{2}$ ,  $\cos (A + B) = \frac{1}{2}$ ,  $0^\circ < A + B \leq 90^\circ$ ,  $A > B$ , find A and B.

**Solution :** Since,  $\sin (A - B) = \frac{1}{2}$ , therefore,  $A - B = 30^\circ$  (Why?) (1)

Also, since  $\cos (A + B) = \frac{1}{2}$ , therefore,  $A + B = 60^\circ$  (Why?) (2)

Solving (1) and (2), we get :  $A = 45^\circ$  and  $B = 15^\circ$ .

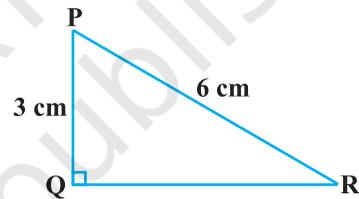


Fig. 8.20

## EXERCISE 8.2

1. Evaluate the following :

(i)  $\sin 60^\circ \cos 30^\circ + \sin 30^\circ \cos 60^\circ$

(ii)  $2 \tan^2 45^\circ + \cos^2 30^\circ - \sin^2 60^\circ$

(iii)  $\frac{\cos 45^\circ}{\sec 30^\circ + \operatorname{cosec} 30^\circ}$

(iv)  $\frac{\sin 30^\circ + \tan 45^\circ - \operatorname{cosec} 60^\circ}{\sec 30^\circ + \cos 60^\circ + \cot 45^\circ}$

(v)  $\frac{5 \cos^2 60^\circ + 4 \sec^2 30^\circ - \tan^2 45^\circ}{\sin^2 30^\circ + \cos^2 30^\circ}$

2. Choose the correct option and justify your choice :

(i)  $\frac{2 \tan 30^\circ}{1 + \tan^2 30^\circ} =$

(A)  $\sin 60^\circ$

(B)  $\cos 60^\circ$

(C)  $\tan 60^\circ$

(D)  $\sin 30^\circ$

(ii)  $\frac{1 - \tan^2 45^\circ}{1 + \tan^2 45^\circ} =$

(A)  $\tan 90^\circ$

(B) 1

(C)  $\sin 45^\circ$

(D) 0

(iii)  $\sin 2A = 2 \sin A$  is true when  $A =$

(A)  $0^\circ$

(B)  $30^\circ$

(C)  $45^\circ$

(D)  $60^\circ$

(iv)  $\frac{2 \tan 30^\circ}{1 - \tan^2 30^\circ} =$

(A)  $\cos 60^\circ$

(B)  $\sin 60^\circ$

(C)  $\tan 60^\circ$

(D)  $\sin 30^\circ$

3. If  $\tan(A + B) = \sqrt{3}$  and  $\tan(A - B) = \frac{1}{\sqrt{3}}$ ;  $0^\circ < A + B \leq 90^\circ$ ;  $A > B$ , find  $A$  and  $B$ .

4. State whether the following are true or false. Justify your answer.

(i)  $\sin(A + B) = \sin A + \sin B$ .

(ii) The value of  $\sin \theta$  increases as  $\theta$  increases.

(iii) The value of  $\cos \theta$  increases as  $\theta$  increases.

(iv)  $\sin \theta = \cos \theta$  for all values of  $\theta$ .

(v)  $\cot A$  is not defined for  $A = 0^\circ$ .

## 8.4 Trigonometric Ratios of Complementary Angles

Recall that two angles are said to be complementary if their sum equals  $90^\circ$ . In  $\triangle ABC$ , right-angled at  $B$ , do you see any pair of complementary angles? (See Fig. 8.21)

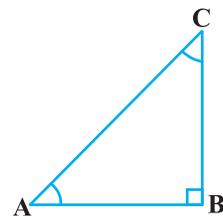


Fig. 8.21

Since  $\angle A + \angle C = 90^\circ$ , they form such a pair. We have:

$$\left. \begin{array}{lll} \sin A = \frac{BC}{AC} & \cos A = \frac{AB}{AC} & \tan A = \frac{BC}{AB} \\ \operatorname{cosec} A = \frac{AC}{BC} & \sec A = \frac{AC}{AB} & \cot A = \frac{AB}{BC} \end{array} \right\} \quad (1)$$

Now let us write the trigonometric ratios for  $\angle C = 90^\circ - \angle A$ .

For convenience, we shall write  $90^\circ - A$  instead of  $90^\circ - \angle A$ .

What would be the side opposite and the side adjacent to the angle  $90^\circ - A$ ?

You will find that AB is the side opposite and BC is the side adjacent to the angle  $90^\circ - A$ . Therefore,

$$\left. \begin{array}{lll} \sin (90^\circ - A) = \frac{AB}{AC}, & \cos (90^\circ - A) = \frac{BC}{AC}, & \tan (90^\circ - A) = \frac{AB}{BC} \\ \operatorname{cosec} (90^\circ - A) = \frac{AC}{AB}, & \sec (90^\circ - A) = \frac{AC}{BC}, & \cot (90^\circ - A) = \frac{BC}{AB} \end{array} \right\} \quad (2)$$

Now, compare the ratios in (1) and (2). Observe that :

$$\sin (90^\circ - A) = \frac{AB}{AC} = \cos A \text{ and } \cos (90^\circ - A) = \frac{BC}{AC} = \sin A$$

Also,  $\tan (90^\circ - A) = \frac{AB}{BC} = \cot A, \quad \cot (90^\circ - A) = \frac{BC}{AB} = \tan A$

$$\sec (90^\circ - A) = \frac{AC}{BC} = \operatorname{cosec} A, \quad \operatorname{cosec} (90^\circ - A) = \frac{AC}{AB} = \sec A$$

$$\begin{array}{ll} \text{So, } \sin (90^\circ - A) = \cos A, & \cos (90^\circ - A) = \sin A, \\ \tan (90^\circ - A) = \cot A, & \cot (90^\circ - A) = \tan A, \\ \sec (90^\circ - A) = \operatorname{cosec} A, & \operatorname{cosec} (90^\circ - A) = \sec A, \end{array}$$

for all values of angle A lying between  $0^\circ$  and  $90^\circ$ . Check whether this holds for  $A = 0^\circ$  or  $A = 90^\circ$ .

**Note :**  $\tan 0^\circ = 0 = \cot 90^\circ$ ,  $\sec 0^\circ = 1 = \operatorname{cosec} 90^\circ$  and  $\sec 90^\circ$ ,  $\operatorname{cosec} 0^\circ$ ,  $\tan 90^\circ$  and  $\cot 0^\circ$  are not defined.

Now, let us consider some examples.

**Example 9 :** Evaluate  $\frac{\tan 65^\circ}{\cot 25^\circ}$ .

**Solution :** We know :  $\cot A = \tan (90^\circ - A)$

So,  $\cot 25^\circ = \tan (90^\circ - 25^\circ) = \tan 65^\circ$

i.e.,  $\frac{\tan 65^\circ}{\cot 25^\circ} = \frac{\tan 65^\circ}{\tan 65^\circ} = 1$

**Example 10 :** If  $\sin 3A = \cos (A - 26^\circ)$ , where  $3A$  is an acute angle, find the value of  $A$ .

**Solution :** We are given that  $\sin 3A = \cos (A - 26^\circ)$ . (1)

Since  $\sin 3A = \cos (90^\circ - 3A)$ , we can write (1) as

$$\cos (90^\circ - 3A) = \cos (A - 26^\circ)$$

Since  $90^\circ - 3A$  and  $A - 26^\circ$  are both acute angles, therefore,

$$90^\circ - 3A = A - 26^\circ$$

which gives  $A = 29^\circ$

**Example 11 :** Express  $\cot 85^\circ + \cos 75^\circ$  in terms of trigonometric ratios of angles between  $0^\circ$  and  $45^\circ$ .

**Solution :**  $\cot 85^\circ + \cos 75^\circ = \cot (90^\circ - 5^\circ) + \cos (90^\circ - 15^\circ)$   
 $= \tan 5^\circ + \sin 15^\circ$

### EXERCISE 8.3

1. Evaluate :

$$(i) \frac{\sin 18^\circ}{\cos 72^\circ} \quad (ii) \frac{\tan 26^\circ}{\cot 64^\circ} \quad (iii) \cos 48^\circ - \sin 42^\circ \quad (iv) \operatorname{cosec} 31^\circ - \sec 59^\circ$$

2. Show that :

$$(i) \tan 48^\circ \tan 23^\circ \tan 42^\circ \tan 67^\circ = 1$$

$$(ii) \cos 38^\circ \cos 52^\circ - \sin 38^\circ \sin 52^\circ = 0$$

3. If  $\tan 2A = \cot (A - 18^\circ)$ , where  $2A$  is an acute angle, find the value of  $A$ .

4. If  $\tan A = \cot B$ , prove that  $A + B = 90^\circ$ .

5. If  $\sec 4A = \operatorname{cosec} (A - 20^\circ)$ , where  $4A$  is an acute angle, find the value of  $A$ .

6. If A, B and C are interior angles of a triangle ABC, then show that

$$\sin\left(\frac{B+C}{2}\right) = \cos\frac{A}{2}.$$

7. Express  $\sin 67^\circ + \cos 75^\circ$  in terms of trigonometric ratios of angles between  $0^\circ$  and  $45^\circ$ .

### 8.5 Trigonometric Identities

You may recall that an equation is called an identity when it is true for all values of the variables involved. Similarly, an equation involving trigonometric ratios of an angle is called a **trigonometric identity**, if it is true for all values of the angle(s) involved.

In this section, we will prove one trigonometric identity, and use it further to prove other useful trigonometric identities.

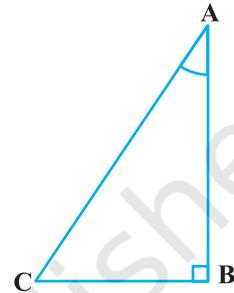


Fig. 8.22

In  $\Delta ABC$ , right-angled at B (see Fig. 8.22), we have:

$$AB^2 + BC^2 = AC^2 \quad (1)$$

Dividing each term of (1) by  $AC^2$ , we get

$$\frac{AB^2}{AC^2} + \frac{BC^2}{AC^2} = \frac{AC^2}{AC^2}$$

i.e., 
$$\left(\frac{AB}{AC}\right)^2 + \left(\frac{BC}{AC}\right)^2 = \left(\frac{AC}{AC}\right)^2$$

i.e., 
$$(\cos A)^2 + (\sin A)^2 = 1$$

i.e., 
$$\cos^2 A + \sin^2 A = 1 \quad (2)$$

This is true for all A such that  $0^\circ \leq A \leq 90^\circ$ . So, this is a trigonometric identity.

Let us now divide (1) by  $AB^2$ . We get

$$\frac{AB^2}{AB^2} + \frac{BC^2}{AB^2} = \frac{AC^2}{AB^2}$$

or, 
$$\left(\frac{AB}{AB}\right)^2 + \left(\frac{BC}{AB}\right)^2 = \left(\frac{AC}{AB}\right)^2$$

i.e., 
$$1 + \tan^2 A = \sec^2 A \quad (3)$$

Is this equation true for  $A = 0^\circ$ ? Yes, it is. What about  $A = 90^\circ$ ? Well,  $\tan A$  and  $\sec A$  are not defined for  $A = 90^\circ$ . So, (3) is true for all  $A$  such that  $0^\circ \leq A < 90^\circ$ .

Let us see what we get on dividing (1) by  $BC^2$ . We get

$$\frac{AB^2}{BC^2} + \frac{BC^2}{BC^2} = \frac{AC^2}{BC^2}$$

i.e., 
$$\left(\frac{AB}{BC}\right)^2 + \left(\frac{BC}{BC}\right)^2 = \left(\frac{AC}{BC}\right)^2$$

i.e., 
$$\cot^2 A + 1 = \operatorname{cosec}^2 A \quad (4)$$

Note that  $\operatorname{cosec} A$  and  $\cot A$  are not defined for  $A = 0^\circ$ . Therefore (4) is true for all  $A$  such that  $0^\circ < A \leq 90^\circ$ .

Using these identities, we can express each trigonometric ratio in terms of other trigonometric ratios, i.e., if any one of the ratios is known, we can also determine the values of other trigonometric ratios.

Let us see how we can do this using these identities. Suppose we know that

$\tan A = \frac{1}{\sqrt{3}}$ . Then,  $\cot A = \sqrt{3}$ .

Since,  $\sec^2 A = 1 + \tan^2 A = 1 + \frac{1}{3} = \frac{4}{3}$ ,  $\sec A = \frac{2}{\sqrt{3}}$ , and  $\cos A = \frac{\sqrt{3}}{2}$ .

Again,  $\sin A = \sqrt{1 - \cos^2 A} = \sqrt{1 - \frac{3}{4}} = \frac{1}{2}$ . Therefore,  $\operatorname{cosec} A = 2$ .

**Example 12 :** Express the ratios  $\cos A$ ,  $\tan A$  and  $\sec A$  in terms of  $\sin A$ .

**Solution :** Since  $\cos^2 A + \sin^2 A = 1$ , therefore,

$$\cos^2 A = 1 - \sin^2 A, \text{ i.e., } \cos A = \pm \sqrt{1 - \sin^2 A}$$

This gives 
$$\cos A = \sqrt{1 - \sin^2 A} \quad (\text{Why?})$$

Hence, 
$$\tan A = \frac{\sin A}{\cos A} = \frac{\sin A}{\sqrt{1 - \sin^2 A}} \text{ and } \sec A = \frac{1}{\cos A} = \frac{1}{\sqrt{1 - \sin^2 A}}$$

**Example 13 :** Prove that  $\sec A (1 - \sin A)(\sec A + \tan A) = 1$ .

**Solution :**

$$\begin{aligned} \text{LHS} &= \sec A (1 - \sin A)(\sec A + \tan A) = \left(\frac{1}{\cos A}\right)(1 - \sin A)\left(\frac{1}{\cos A} + \frac{\sin A}{\cos A}\right) \\ &= \frac{(1 - \sin A)(1 + \sin A)}{\cos^2 A} = \frac{1 - \sin^2 A}{\cos^2 A} \\ &= \frac{\cos^2 A}{\cos^2 A} = 1 = \text{RHS} \end{aligned}$$

**Example 14 :** Prove that  $\frac{\cot A - \cos A}{\cot A + \cos A} = \frac{\operatorname{cosec} A - 1}{\operatorname{cosec} A + 1}$

$$\begin{aligned} \text{Solution : LHS} &= \frac{\cot A - \cos A}{\cot A + \cos A} = \frac{\frac{\cos A}{\sin A} - \cos A}{\frac{\cos A}{\sin A} + \cos A} \\ &= \frac{\cos A \left(\frac{1}{\sin A} - 1\right)}{\cos A \left(\frac{1}{\sin A} + 1\right)} = \frac{\left(\frac{1}{\sin A} - 1\right)}{\left(\frac{1}{\sin A} + 1\right)} = \frac{\operatorname{cosec} A - 1}{\operatorname{cosec} A + 1} = \text{RHS} \end{aligned}$$

**Example 15 :** Prove that  $\frac{\sin \theta - \cos \theta + 1}{\sin \theta + \cos \theta - 1} = \frac{1}{\sec \theta - \tan \theta}$ , using the identity

$$\sec^2 \theta = 1 + \tan^2 \theta.$$

**Solution :** Since we will apply the identity involving  $\sec \theta$  and  $\tan \theta$ , let us first convert the LHS (of the identity we need to prove) in terms of  $\sec \theta$  and  $\tan \theta$  by dividing numerator and denominator by  $\cos \theta$ .

$$\begin{aligned} \text{LHS} &= \frac{\sin \theta - \cos \theta + 1}{\sin \theta + \cos \theta - 1} = \frac{\tan \theta - 1 + \sec \theta}{\tan \theta + 1 - \sec \theta} \\ &= \frac{(\tan \theta + \sec \theta) - 1}{(\tan \theta - \sec \theta) + 1} = \frac{\{(\tan \theta + \sec \theta) - 1\} (\tan \theta - \sec \theta)}{\{(\tan \theta - \sec \theta) + 1\} (\tan \theta - \sec \theta)} \end{aligned}$$

$$\begin{aligned}
 &= \frac{(\tan^2 \theta - \sec^2 \theta) - (\tan \theta - \sec \theta)}{\{\tan \theta - \sec \theta + 1\} (\tan \theta - \sec \theta)} \\
 &= \frac{-1 - \tan \theta + \sec \theta}{(\tan \theta - \sec \theta + 1) (\tan \theta - \sec \theta)} \\
 &= \frac{-1}{\tan \theta - \sec \theta} = \frac{1}{\sec \theta - \tan \theta},
 \end{aligned}$$

which is the RHS of the identity, we are required to prove.

### EXERCISE 8.4

- Express the trigonometric ratios  $\sin A$ ,  $\sec A$  and  $\tan A$  in terms of  $\cot A$ .
- Write all the other trigonometric ratios of  $\angle A$  in terms of  $\sec A$ .
- Evaluate :

(i)  $\frac{\sin^2 63^\circ + \sin^2 27^\circ}{\cos^2 17^\circ + \cos^2 73^\circ}$

(ii)  $\sin 25^\circ \cos 65^\circ + \cos 25^\circ \sin 65^\circ$

- Choose the correct option. Justify your choice.

(i)  $9 \sec^2 A - 9 \tan^2 A =$

(A) 1                      (B) 9                      (C) 8                      (D) 0

(ii)  $(1 + \tan \theta + \sec \theta) (1 + \cot \theta - \operatorname{cosec} \theta) =$

(A) 0                      (B) 1                      (C) 2                      (D) -1

(iii)  $(\sec A + \tan A) (1 - \sin A) =$

(A)  $\sec A$                       (B)  $\sin A$                       (C)  $\operatorname{cosec} A$                       (D)  $\cos A$

(iv)  $\frac{1 + \tan^2 A}{1 + \cot^2 A} =$

(A)  $\sec^2 A$                       (B) -1                      (C)  $\cot^2 A$                       (D)  $\tan^2 A$

- Prove the following identities, where the angles involved are acute angles for which the expressions are defined.

(i)  $(\operatorname{cosec} \theta - \cot \theta)^2 = \frac{1 - \cos \theta}{1 + \cos \theta}$

(ii)  $\frac{\cos A}{1 + \sin A} + \frac{1 + \sin A}{\cos A} = 2 \sec A$

$$(iii) \frac{\tan \theta}{1 - \cot \theta} + \frac{\cot \theta}{1 - \tan \theta} = 1 + \sec \theta \operatorname{cosec} \theta$$

[Hint : Write the expression in terms of  $\sin \theta$  and  $\cos \theta$ ]

$$(iv) \frac{1 + \sec A}{\sec A} = \frac{\sin^2 A}{1 - \cos A} \quad [\text{Hint : Simplify LHS and RHS separately}]$$

$$(v) \frac{\cos A - \sin A + 1}{\cos A + \sin A - 1} = \operatorname{cosec} A + \cot A, \text{ using the identity } \operatorname{cosec}^2 A = 1 + \cot^2 A.$$

$$(vi) \sqrt{\frac{1 + \sin A}{1 - \sin A}} = \sec A + \tan A \quad (vii) \frac{\sin \theta - 2 \sin^3 \theta}{2 \cos^3 \theta - \cos \theta} = \tan \theta$$

$$(viii) (\sin A + \operatorname{cosec} A)^2 + (\cos A + \sec A)^2 = 7 + \tan^2 A + \cot^2 A$$

$$(ix) (\operatorname{cosec} A - \sin A)(\sec A - \cos A) = \frac{1}{\tan A + \cot A}$$

[Hint : Simplify LHS and RHS separately]

$$(x) \left( \frac{1 + \tan^2 A}{1 + \cot^2 A} \right) = \left( \frac{1 - \tan A}{1 - \cot A} \right)^2 = \tan^2 A$$

## 8.6 Summary

In this chapter, you have studied the following points :

1. In a right triangle ABC, right-angled at B,

$$\sin A = \frac{\text{side opposite to angle } A}{\text{hypotenuse}}, \quad \cos A = \frac{\text{side adjacent to angle } A}{\text{hypotenuse}}$$

$$\tan A = \frac{\text{side opposite to angle } A}{\text{side adjacent to angle } A}$$

2.  $\operatorname{cosec} A = \frac{1}{\sin A}$ ;  $\sec A = \frac{1}{\cos A}$ ;  $\tan A = \frac{1}{\cot A}$ ,  $\tan A = \frac{\sin A}{\cos A}$ .

3. If one of the trigonometric ratios of an acute angle is known, the remaining trigonometric ratios of the angle can be easily determined.

4. The values of trigonometric ratios for angles  $0^\circ$ ,  $30^\circ$ ,  $45^\circ$ ,  $60^\circ$  and  $90^\circ$ .

5. The value of  $\sin A$  or  $\cos A$  never exceeds 1, whereas the value of  $\sec A$  or  $\operatorname{cosec} A$  is always greater than or equal to 1.

6.  $\sin(90^\circ - A) = \cos A$ ,  $\cos(90^\circ - A) = \sin A$ ;  
 $\tan(90^\circ - A) = \cot A$ ,  $\cot(90^\circ - A) = \tan A$ ;  
 $\sec(90^\circ - A) = \operatorname{cosec} A$ ,  $\operatorname{cosec}(90^\circ - A) = \sec A$ .

7.  $\sin^2 A + \cos^2 A = 1$ ,  
 $\sec^2 A - \tan^2 A = 1$  for  $0^\circ \leq A < 90^\circ$ ,  
 $\operatorname{cosec}^2 A = 1 + \cot^2 A$  for  $0^\circ < A \leq 90^\circ$ .



1062CH09

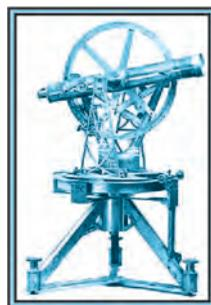
# SOME APPLICATIONS OF TRIGONOMETRY

# 9

## 9.1 Introduction

In the previous chapter, you have studied about trigonometric ratios. In this chapter, you will be studying about some ways in which trigonometry is used in the life around you. Trigonometry is one of the most ancient subjects studied by scholars all over the world. As we have said in Chapter 8, trigonometry was invented because its need arose in astronomy. Since then the astronomers have used it, for instance, to calculate distances from the Earth to the planets and stars. Trigonometry is also used in geography and in navigation. The knowledge of trigonometry is used to construct maps, determine the position of an island in relation to the longitudes and latitudes.

Surveyors have used trigonometry for centuries. One such large surveying project of the nineteenth century was the ‘**Great Trigonometric Survey**’ of British India for which the two largest-ever theodolites were built. During the survey in 1852, the highest mountain in the world was discovered. From a distance of over 160 km, the peak was observed from six different stations. In 1856, this peak was named after Sir George Everest, who had commissioned and first used the giant theodolites (see the figure alongside). The theodolites are now on display in the Museum of the Survey of India in Dehradun.



**A Theodolite**

(Surveying instrument, which is based on the Principles of trigonometry, is used for measuring angles with a rotating telescope)

In this chapter, we will see how trigonometry is used for finding the heights and distances of various objects, without actually measuring them.

## 9.2 Heights and Distances

Let us consider Fig. 8.1 of previous chapter, which is redrawn below in Fig. 9.1.

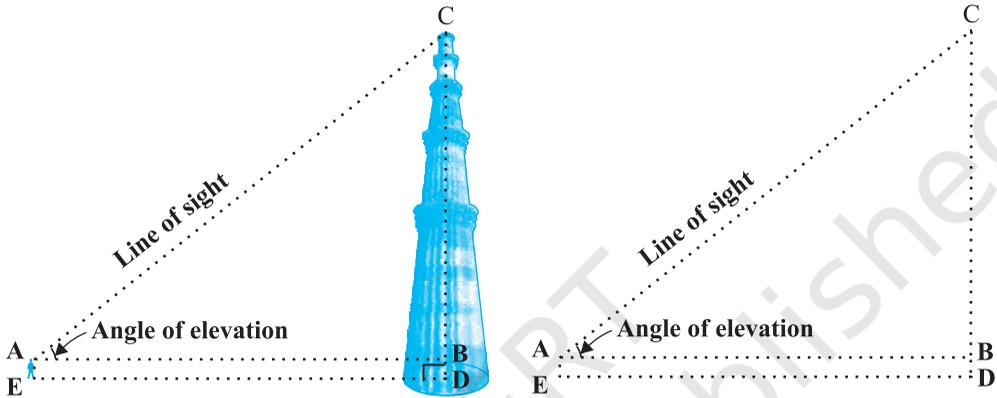


Fig. 9.1

In this figure, the line AC drawn from the eye of the student to the top of the minar is called the *line of sight*. The student is looking at the top of the minar. The angle BAC, so formed by the line of sight with the horizontal, is called the *angle of elevation* of the top of the minar from the eye of the student.

Thus, the **line of sight** is the line drawn from the eye of an observer to the point in the object viewed by the observer. The **angle of elevation** of the point viewed is the angle formed by the line of sight with the horizontal when the point being viewed is above the horizontal level, i.e., the case when we raise our head to look at the object (see Fig. 9.2).

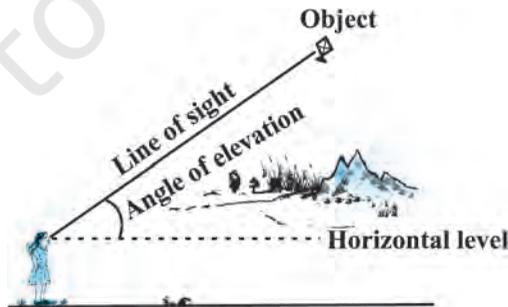


Fig. 9.2

Now, consider the situation given in Fig. 8.2. The girl sitting on the balcony is *looking down* at a flower pot placed on a stair of the temple. In this case, the line of sight is *below* the horizontal level. The angle so formed by the line of sight with the horizontal is called the *angle of depression*.

Thus, the **angle of depression** of a point on the object being viewed is the angle formed by the line of sight with the horizontal when the point is below the horizontal level, i.e., the case when we lower our head to look at the point being viewed (see Fig. 9.3).

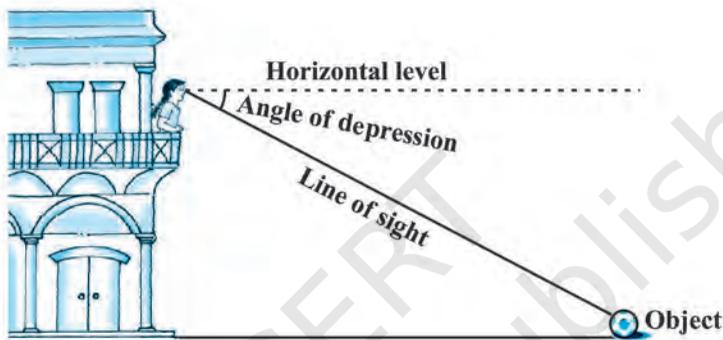


Fig. 9.3

Now, you may identify the lines of sight, and the angles so formed in Fig. 8.3. Are they angles of elevation or angles of depression?

Let us refer to Fig. 9.1 again. If you want to find the height  $CD$  of the minar without actually measuring it, what information do you need? You would need to know the following:

- (i) the distance  $DE$  at which the student is standing from the foot of the minar
- (ii) the angle of elevation,  $\angle BAC$ , of the top of the minar
- (iii) the height  $AE$  of the student.

Assuming that the above three conditions are known, how can we determine the height of the minar?

In the figure,  $CD = CB + BD$ . Here,  $BD = AE$ , which is the height of the student.

To find  $BC$ , we will use trigonometric ratios of  $\angle BAC$  or  $\angle A$ .

In  $\triangle ABC$ , the side  $BC$  is the opposite side in relation to the known  $\angle A$ . Now, which of the trigonometric ratios can we use? Which one of them has the two values that we have and the one we need to determine? Our search narrows down to using either  $\tan A$  or  $\cot A$ , as these ratios involve  $AB$  and  $BC$ .

Therefore,  $\tan A = \frac{BC}{AB}$  or  $\cot A = \frac{AB}{BC}$ , which on solving would give us BC.

By adding AE to BC, you will get the height of the minar.

Now let us explain the process, we have just discussed, by solving some problems.

**Example 1 :** A tower stands vertically on the ground. From a point on the ground, which is 15 m away from the foot of the tower, the angle of elevation of the top of the tower is found to be  $60^\circ$ . Find the height of the tower.

**Solution :** First let us draw a simple diagram to represent the problem (see Fig. 9.4). Here AB represents the tower, CB is the distance of the point from the tower and  $\angle ACB$  is the angle of elevation. We need to determine the height of the tower, i.e., AB. Also, ACB is a triangle, right-angled at B.

To solve the problem, we choose the trigonometric ratio  $\tan 60^\circ$  (or  $\cot 60^\circ$ ), as the ratio involves AB and BC.

$$\text{Now,} \quad \tan 60^\circ = \frac{AB}{BC}$$

$$\text{i.e.,} \quad \sqrt{3} = \frac{AB}{15}$$

$$\text{i.e.,} \quad AB = 15\sqrt{3}$$

Hence, the height of the tower is  $15\sqrt{3}$  m.

**Example 2 :** An electrician has to repair an electric fault on a pole of height 5 m. She needs to reach a point 1.3m below the top of the pole to undertake the repair work (see Fig. 9.5). What should be the length of the ladder that she should use which, when inclined at an angle of  $60^\circ$  to the horizontal, would enable her to reach the required position? Also, how far from the foot of the pole should she place the foot of the ladder? (You may take  $\sqrt{3} = 1.73$ )

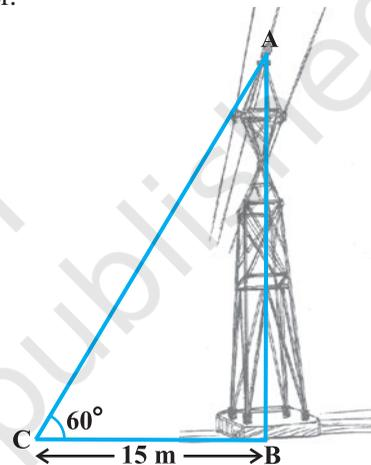


Fig. 9.4

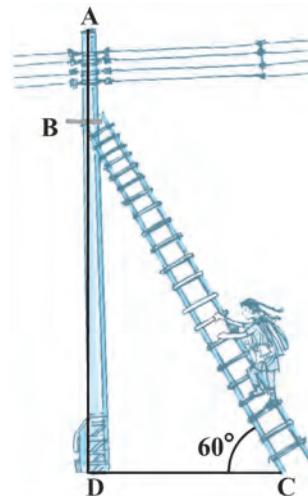


Fig. 9.5

**Solution :** In Fig. 9.5, the electrician is required to reach the point B on the pole AD.

So,  $BD = AD - AB = (5 - 1.3)\text{m} = 3.7\text{ m}$ .

Here, BC represents the ladder. We need to find its length, i.e., the hypotenuse of the right triangle BDC.

Now, can you think which trigonometric ratio should we consider?

It should be  $\sin 60^\circ$ .

So, 
$$\frac{BD}{BC} = \sin 60^\circ \text{ or } \frac{3.7}{BC} = \frac{\sqrt{3}}{2}$$

Therefore, 
$$BC = \frac{3.7 \times 2}{\sqrt{3}} = 4.28\text{ m (approx.)}$$

i.e., the length of the ladder should be 4.28 m.

Now, 
$$\frac{DC}{BD} = \cot 60^\circ = \frac{1}{\sqrt{3}}$$

i.e., 
$$DC = \frac{3.7}{\sqrt{3}} = 2.14\text{ m (approx.)}$$

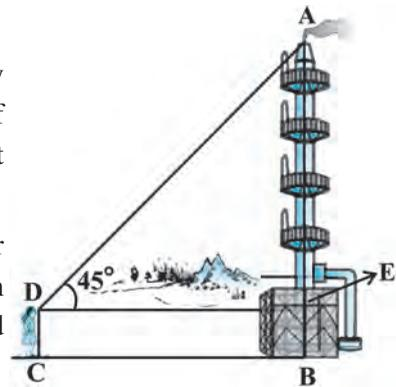
Therefore, she should place the foot of the ladder at a distance of 2.14 m from the pole.

**Example 3 :** An observer 1.5 m tall is 28.5 m away from a chimney. The angle of elevation of the top of the chimney from her eyes is  $45^\circ$ . What is the height of the chimney?

**Solution :** Here, AB is the chimney, CD the observer and  $\angle ADE$  the angle of elevation (see Fig. 9.6). In this case, ADE is a triangle, right-angled at E and we are required to find the height of the chimney.

We have  $AB = AE + BE = AE + 1.5$

and  $DE = CB = 28.5\text{ m}$



**Fig. 9.6**

To determine AE, we choose a trigonometric ratio, which involves both AE and DE. Let us choose the tangent of the angle of elevation.

Now, 
$$\tan 45^\circ = \frac{AE}{DE}$$

i.e., 
$$1 = \frac{AE}{28.5}$$

Therefore, 
$$AE = 28.5$$

So the height of the chimney (AB) = (28.5 + 1.5) m = 30 m.

**Example 4 :** From a point P on the ground the angle of elevation of the top of a 10 m tall building is  $30^\circ$ . A flag is hoisted at the top of the building and the angle of elevation of the top of the flagstaff from P is  $45^\circ$ . Find the length of the flagstaff and the distance of the building from the point P. (You may take  $\sqrt{3} = 1.732$ )

**Solution :** In Fig. 9.7, AB denotes the height of the building, BD the flagstaff and P the given point. Note that there are two right triangles PAB and PAD. We are required to find the length of the flagstaff, i.e., DB and the distance of the building from the point P, i.e., PA.

Since, we know the height of the building AB, we will first consider the right  $\Delta$  PAB.

We have 
$$\tan 30^\circ = \frac{AB}{AP}$$

i.e., 
$$\frac{1}{\sqrt{3}} = \frac{10}{AP}$$

Therefore, 
$$AP = 10\sqrt{3}$$

i.e., the distance of the building from P is  $10\sqrt{3}$  m = 17.32 m.

Next, let us suppose DB = x m. Then AD = (10 + x) m.

Now, in right  $\Delta$  PAD, 
$$\tan 45^\circ = \frac{AD}{AP} = \frac{10 + x}{10\sqrt{3}}$$

Therefore, 
$$1 = \frac{10 + x}{10\sqrt{3}}$$

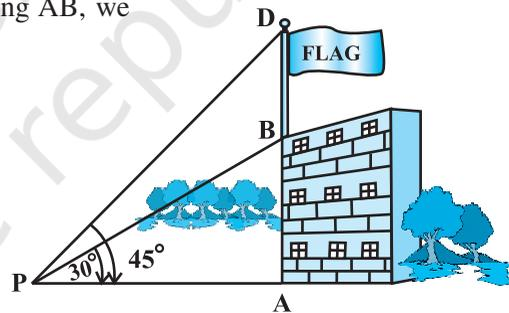


Fig. 9.7

i.e., 
$$x = 10(\sqrt{3} - 1) = 7.32$$

So, the length of the flagstaff is 7.32 m.

**Example 5 :** The shadow of a tower standing on a level ground is found to be 40 m longer when the Sun's altitude is  $30^\circ$  than when it is  $60^\circ$ . Find the height of the tower.

**Solution :** In Fig. 9.8, AB is the tower and BC is the length of the shadow when the Sun's altitude is  $60^\circ$ , i.e., the angle of elevation of the top of the tower from the tip of the shadow is  $60^\circ$  and DB is the length of the shadow, when the angle of elevation is  $30^\circ$ .

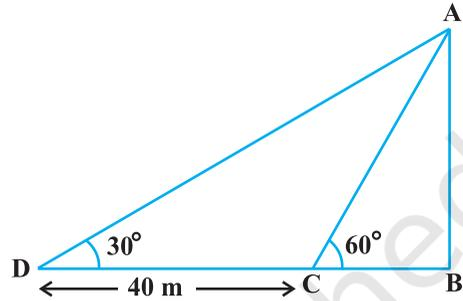


Fig. 9.8

Now, let AB be  $h$  m and BC be  $x$  m. According to the question, DB is 40 m longer than BC.

So, 
$$DB = (40 + x) \text{ m}$$

Now, we have two right triangles ABC and ABD.

In  $\Delta ABC$ , 
$$\tan 60^\circ = \frac{AB}{BC}$$

or, 
$$\sqrt{3} = \frac{h}{x} \quad (1)$$

In  $\Delta ABD$ , 
$$\tan 30^\circ = \frac{AB}{BD}$$

i.e., 
$$\frac{1}{\sqrt{3}} = \frac{h}{x + 40} \quad (2)$$

From (1), we have 
$$h = x\sqrt{3}$$

Putting this value in (2), we get  $(x\sqrt{3})\sqrt{3} = x + 40$ , i.e.,  $3x = x + 40$

i.e., 
$$x = 20$$

So, 
$$h = 20\sqrt{3} \quad [\text{From (1)}]$$

Therefore, the height of the tower is  $20\sqrt{3}$  m.

**Example 6 :** The angles of depression of the top and the bottom of an 8 m tall building from the top of a multi-storeyed building are  $30^\circ$  and  $45^\circ$ , respectively. Find the height of the multi-storeyed building and the distance between the two buildings.

**Solution :** In Fig. 9.9, PC denotes the multi-storeyed building and AB denotes the 8 m tall building. We are interested to determine the height of the multi-storeyed building, i.e., PC and the distance between the two buildings, i.e., AC.

Look at the figure carefully. Observe that PB is a transversal to the parallel lines PQ and BD. Therefore,  $\angle QPB$  and  $\angle PBD$  are alternate angles, and so are equal. So  $\angle PBD = 30^\circ$ . Similarly,  $\angle PAC = 45^\circ$ .

In right  $\triangle PBD$ , we have

$$\frac{PD}{BD} = \tan 30^\circ = \frac{1}{\sqrt{3}} \quad \text{or} \quad BD = PD\sqrt{3}$$

In right  $\triangle PAC$ , we have

$$\frac{PC}{AC} = \tan 45^\circ = 1$$

i.e.,  $PC = AC$

Also,  $PC = PD + DC$ , therefore,  $PD + DC = AC$ .

Since,  $AC = BD$  and  $DC = AB = 8$  m, we get  $PD + 8 = BD = PD\sqrt{3}$  (Why?)

This gives 
$$PD = \frac{8}{\sqrt{3} - 1} = \frac{8(\sqrt{3} + 1)}{(\sqrt{3} + 1)(\sqrt{3} - 1)} = 4(\sqrt{3} + 1)\text{ m.}$$

So, the height of the multi-storeyed building is  $\{4(\sqrt{3} + 1) + 8\}$  m =  $4(3 + \sqrt{3})$  m

and the distance between the two buildings is also  $4(3 + \sqrt{3})$  m.

**Example 7 :** From a point on a bridge across a river, the angles of depression of the banks on opposite sides of the river are  $30^\circ$  and  $45^\circ$ , respectively. If the bridge is at a height of 3 m from the banks, find the width of the river.

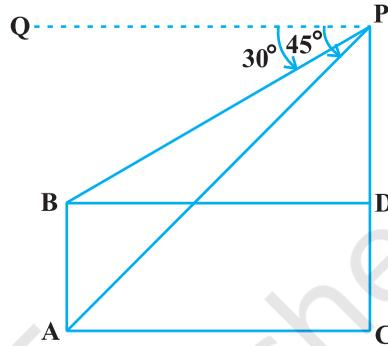


Fig. 9.9

**Solution :** In Fig 9.10, A and B represent points on the bank on opposite sides of the river, so that AB is the width of the river. P is a point on the bridge at a height of 3 m, i.e.,  $DP = 3$  m. We are interested to determine the width of the river, which is the length of the side AB of the  $\triangle APB$ .

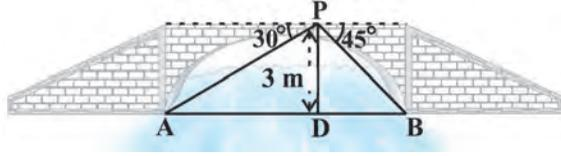


Fig. 9.10

Now,  $AB = AD + DB$

In right  $\triangle APD$ ,  $\angle A = 30^\circ$ .

$$\text{So, } \tan 30^\circ = \frac{PD}{AD}$$

$$\text{i.e., } \frac{1}{\sqrt{3}} = \frac{3}{AD} \text{ or } AD = 3\sqrt{3} \text{ m}$$

Also, in right  $\triangle PBD$ ,  $\angle B = 45^\circ$ . So,  $BD = PD = 3$  m.

$$\text{Now, } AB = BD + AD = 3 + 3\sqrt{3} = 3(1 + \sqrt{3}) \text{ m.}$$

Therefore, the width of the river is  $3(\sqrt{3} + 1)$  m.

### EXERCISE 9.1

1. A circus artist is climbing a 20 m long rope, which is tightly stretched and tied from the top of a vertical pole to the ground. Find the height of the pole, if the angle made by the rope with the ground level is  $30^\circ$  (see Fig. 9.11).
2. A tree breaks due to storm and the broken part bends so that the top of the tree touches the ground making an angle  $30^\circ$  with it. The distance between the foot of the tree to the point where the top touches the ground is 8 m. Find the height of the tree.

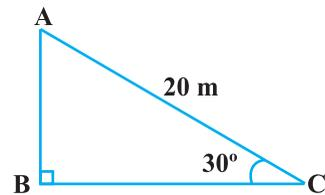


Fig. 9.11

3. A contractor plans to install two slides for the children to play in a park. For the children below the age of 5 years, she prefers to have a slide whose top is at a height of 1.5 m, and

is inclined at an angle of  $30^\circ$  to the ground, whereas for elder children, she wants to have a steep slide at a height of 3 m, and inclined at an angle of  $60^\circ$  to the ground. What should be the length of the slide in each case?

4. The angle of elevation of the top of a tower from a point on the ground, which is 30 m away from the foot of the tower, is  $30^\circ$ . Find the height of the tower.
5. A kite is flying at a height of 60 m above the ground. The string attached to the kite is temporarily tied to a point on the ground. The inclination of the string with the ground is  $60^\circ$ . Find the length of the string, assuming that there is no slack in the string.
6. A 1.5 m tall boy is standing at some distance from a 30 m tall building. The angle of elevation from his eyes to the top of the building increases from  $30^\circ$  to  $60^\circ$  as he walks towards the building. Find the distance he walked towards the building.
7. From a point on the ground, the angles of elevation of the bottom and the top of a transmission tower fixed at the top of a 20 m high building are  $45^\circ$  and  $60^\circ$  respectively. Find the height of the tower.
8. A statue, 1.6 m tall, stands on the top of a pedestal. From a point on the ground, the angle of elevation of the top of the statue is  $60^\circ$  and from the same point the angle of elevation of the top of the pedestal is  $45^\circ$ . Find the height of the pedestal.
9. The angle of elevation of the top of a building from the foot of the tower is  $30^\circ$  and the angle of elevation of the top of the tower from the foot of the building is  $60^\circ$ . If the tower is 50 m high, find the height of the building.
10. Two poles of equal heights are standing opposite each other on either side of the road, which is 80 m wide. From a point between them on the road, the angles of elevation of the top of the poles are  $60^\circ$  and  $30^\circ$ , respectively. Find the height of the poles and the distances of the point from the poles.
11. A TV tower stands vertically on a bank of a canal. From a point on the other bank directly opposite the tower, the angle of elevation of the top of the tower is  $60^\circ$ . From another point 20 m away from this point on the line joining this point to the foot of the tower, the angle of elevation of the top of the tower is  $30^\circ$  (see Fig. 9.12). Find the height of the tower and the width of the canal.

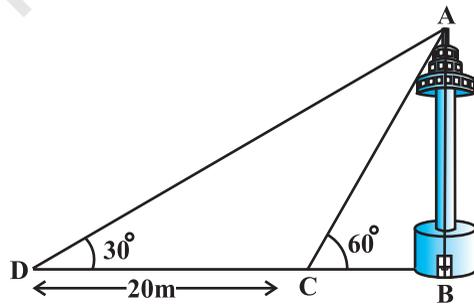


Fig. 9.12

12. From the top of a 7 m high building, the angle of elevation of the top of a cable tower is  $60^\circ$  and the angle of depression of its foot is  $45^\circ$ . Determine the height of the tower.
13. As observed from the top of a 75 m high lighthouse from the sea-level, the angles of depression of two ships are  $30^\circ$  and  $45^\circ$ . If one ship is exactly behind the other on the same side of the lighthouse, find the distance between the two ships.

14. A 1.2 m tall girl spots a balloon moving with the wind in a horizontal line at a height of 88.2 m from the ground. The angle of elevation of the balloon from the eyes of the girl at any instant is  $60^\circ$ . After some time, the angle of elevation reduces to  $30^\circ$  (see Fig. 9.13). Find the distance travelled by the balloon during the interval.

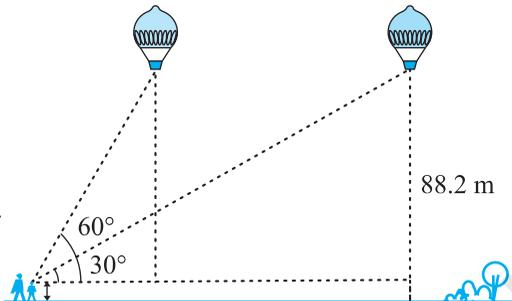


Fig. 9.13

15. A straight highway leads to the foot of a tower. A man standing at the top of the tower observes a car at an angle of depression of  $30^\circ$ , which is approaching the foot of the tower with a uniform speed. Six seconds later, the angle of depression of the car is found to be  $60^\circ$ . Find the time taken by the car to reach the foot of the tower from this point.
16. The angles of elevation of the top of a tower from two points at a distance of 4 m and 9 m from the base of the tower and in the same straight line with it are complementary. Prove that the height of the tower is 6 m.

### 9.3 Summary

In this chapter, you have studied the following points :

- The **line of sight** is the line drawn from the eye of an observer to the point in the object viewed by the observer.
  - The **angle of elevation** of an object viewed, is the angle formed by the line of sight with the horizontal when it is above the horizontal level, i.e., the case when we raise our head to look at the object.
  - The **angle of depression** of an object viewed, is the angle formed by the line of sight with the horizontal when it is below the horizontal level, i.e., the case when we lower our head to look at the object.
- The height or length of an object or the distance between two distant objects can be determined with the help of trigonometric ratios.



1062CH10

# CIRCLES 10

## 10.1 Introduction

You have studied in Class IX that a circle is a collection of all points in a plane which are at a constant distance (radius) from a fixed point (centre). You have also studied various terms related to a circle like chord, segment, sector, arc etc. Let us now examine the different situations that can arise when a circle and a line are given in a plane.

So, let us consider a circle and a line PQ. There can be three possibilities given in Fig. 10.1 below:

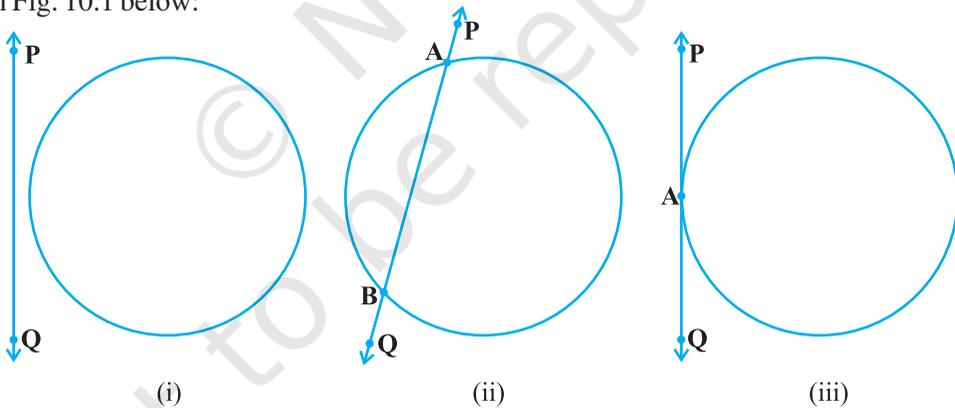


Fig. 10.1

In Fig. 10.1 (i), the line PQ and the circle have no common point. In this case, PQ is called a **non-intersecting** line with respect to the circle. In Fig. 10.1 (ii), there are two common points A and B that the line PQ and the circle have. In this case, we call the line PQ a **secant** of the circle. In Fig. 10.1 (iii), there is only one point A which is common to the line PQ and the circle. In this case, the line is called a **tangent** to the circle.

You might have seen a pulley fitted over a well which is used in taking out water from the well. Look at Fig. 10.2. Here the rope on both sides of the pulley, if considered as a ray, is like a tangent to the circle representing the pulley.

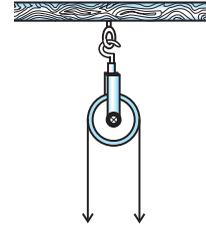


Fig. 10.2

Is there any position of the line with respect to the circle other than the types given above? You can see that there cannot be any other type of position of the line with respect to the circle. In this chapter, we will study about the existence of the tangents to a circle and also study some of their properties.

## 10.2 Tangent to a Circle

In the previous section, you have seen that a **tangent\*** to a circle is a line that intersects the circle at only one point.

To understand the existence of the tangent to a circle at a point, let us perform the following activities:

**Activity 1 :** Take a circular wire and attach a straight wire AB at a point P of the circular wire so that it can rotate about the point P in a plane. Put the system on a table and gently rotate the wire AB about the point P to get different positions of the straight wire [see Fig. 10.3(i)].

In various positions, the wire intersects the circular wire at P and at another point  $Q_1$  or  $Q_2$  or  $Q_3$ , etc. In one position, you will see that it will intersect the circle at the point P only (see position  $A'B'$  of AB). This shows that a tangent exists at the point P of the circle. On rotating further, you can observe that in all other positions of AB, it will intersect the circle at P and at another point, say  $R_1$  or  $R_2$  or  $R_3$ , etc. So, you can observe that **there is only one tangent at a point of the circle.**

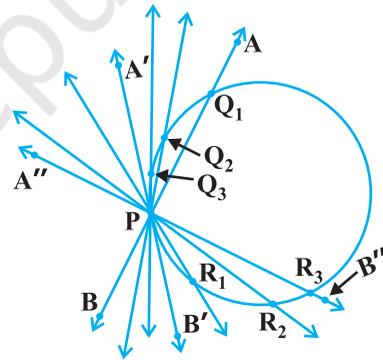


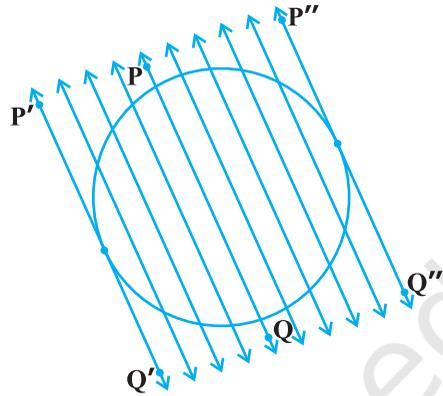
Fig. 10.3 (i)

While doing activity above, you must have observed that as the position AB moves towards the position  $A'B'$ , the common point, say  $Q_1$ , of the line AB and the circle gradually comes nearer and nearer to the common point P. Ultimately, it coincides with the point P in the position  $A'B'$  of  $A''B''$ . Again note, what happens if 'AB' is rotated rightwards about P? The common point  $R_3$  gradually comes nearer and nearer to P and ultimately coincides with P. So, what we see is:

**The tangent to a circle is a special case of the secant, when the two end points of its corresponding chord coincide.**

\*The word 'tangent' comes from the Latin word 'tangere', which means to touch and was introduced by the Danish mathematician Thomas Fineke in 1583.

**Activity 2 :** On a paper, draw a circle and a secant PQ of the circle. Draw various lines parallel to the secant on both sides of it. You will find that after some steps, the length of the chord cut by the lines will gradually decrease, i.e., the two points of intersection of the line and the circle are coming closer and closer [see Fig. 10.3(ii)]. In one case, it becomes zero on one side of the secant and in another case, it becomes zero on the other side of the secant. See the positions P'Q' and P''Q'' of the secant in Fig. 10.3 (ii). These are the tangents to the circle parallel to the given secant PQ. This also helps you to see that there cannot be more than two tangents parallel to a given secant.

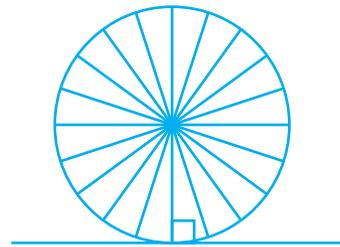


**Fig. 10.3** (ii)

This activity also establishes, what you must have observed, while doing Activity 1, namely, a tangent is the secant when both of the end points of the corresponding chord coincide.

The common point of the tangent and the circle is called the **point of contact** [the point A in Fig. 10.1 (iii)] and the tangent is said to **touch** the circle at the common point.

Now look around you. Have you seen a bicycle or a cart moving? Look at its wheels. All the spokes of a wheel are along its radii. Now note the position of the wheel with respect to its movement on the ground. Do you see any tangent anywhere? (See Fig. 10.4). In fact, the wheel moves along a line which is a tangent to the circle representing the wheel. Also, notice that in all positions, the radius through the point of contact with the ground appears to be at right angles to the tangent (see Fig. 10.4). We shall now prove this property of the tangent.



**Fig. 10.4**

**Theorem 10.1 :** *The tangent at any point of a circle is perpendicular to the radius through the point of contact.*

**Proof :** We are given a circle with centre O and a tangent XY to the circle at a point P. We need to prove that OP is perpendicular to XY.

Take a point Q on XY other than P and join OQ (see Fig. 10.5).

The point Q must lie outside the circle. (Why? Note that if Q lies inside the circle, XY will become a secant and not a tangent to the circle). Therefore, OQ is longer than the radius OP of the circle. That is,

$$OQ > OP.$$

Since this happens for every point on the line XY except the point P, OP is the shortest of all the distances of the point O to the points of XY. So OP is perpendicular to XY. (as shown in Theorem A1.7.)

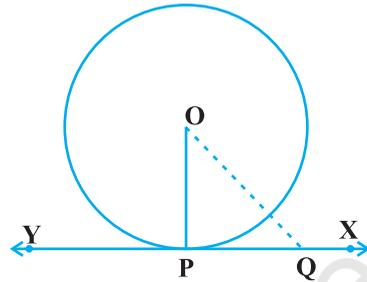


Fig. 10.5

### Remarks :

1. By theorem above, we can also conclude that at any point on a circle there can be one and only one tangent.
2. The line containing the radius through the point of contact is also sometimes called the 'normal' to the circle at the point.

### EXERCISE 10.1

1. How many tangents can a circle have?
2. Fill in the blanks :
  - (i) A tangent to a circle intersects it in \_\_\_\_\_ point (s).
  - (ii) A line intersecting a circle in two points is called a \_\_\_\_\_ .
  - (iii) A circle can have \_\_\_\_\_ parallel tangents at the most.
  - (iv) The common point of a tangent to a circle and the circle is called \_\_\_\_\_ .
3. A tangent PQ at a point P of a circle of radius 5 cm meets a line through the centre O at a point Q so that OQ = 12 cm. Length PQ is :
 

(A) 12 cm      (B) 13 cm      (C) 8.5 cm      (D)  $\sqrt{119}$  cm.
4. Draw a circle and two lines parallel to a given line such that one is a tangent and the other, a secant to the circle.

### 10.3 Number of Tangents from a Point on a Circle

To get an idea of the number of tangents from a point on a circle, let us perform the following activity:

**Activity 3 :** Draw a circle on a paper. Take a point P inside it. Can you draw a tangent to the circle through this point? You will find that all the lines through this point intersect the circle in two points. So, it is not possible to draw any tangent to a circle through a point inside it [see Fig. 10.6 (i)].

Next take a point P on the circle and draw tangents through this point. You have already observed that there is only one tangent to the circle at such a point [see Fig. 10.6 (ii)].

Finally, take a point P outside the circle and try to draw tangents to the circle from this point. What do you observe? You will find that you can draw exactly two tangents to the circle through this point [see Fig. 10.6 (iii)].

We can summarise these facts as follows:

**Case 1 :** There is no tangent to a circle passing through a point lying inside the circle.

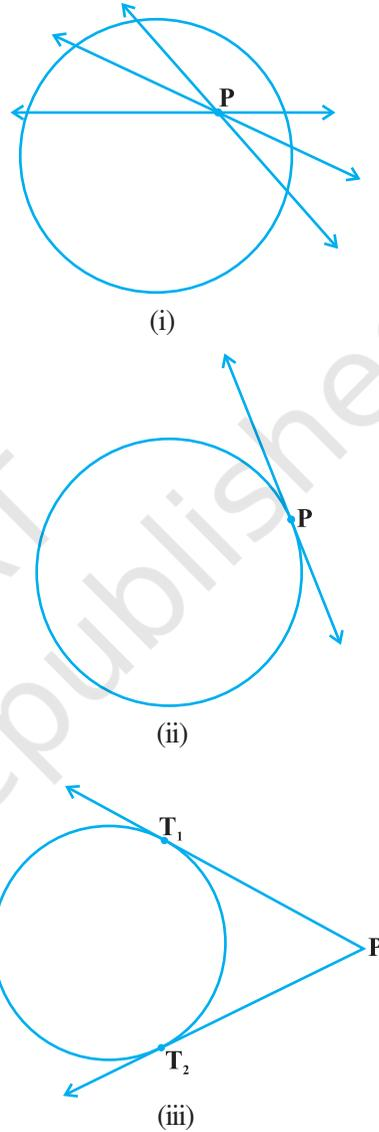
**Case 2 :** There is one and only one tangent to a circle passing through a point lying on the circle.

**Case 3 :** There are exactly two tangents to a circle through a point lying outside the circle.

In Fig. 10.6 (iii),  $T_1$  and  $T_2$  are the points of contact of the tangents  $PT_1$  and  $PT_2$  respectively.

The length of the segment of the tangent from the external point P and the point of contact with the circle is called the **length of the tangent** from the point P to the circle.

Note that in Fig. 10.6 (iii),  $PT_1$  and  $PT_2$  are the lengths of the tangents from P to the circle. The lengths  $PT_1$  and  $PT_2$  have a common property. Can you find this? Measure  $PT_1$  and  $PT_2$ . Are these equal? In fact, this is always so. Let us give a proof of this fact in the following theorem.



**Fig. 10.6**

**Theorem 10.2 :** *The lengths of tangents drawn from an external point to a circle are equal.*

**Proof :** We are given a circle with centre O, a point P lying outside the circle and two tangents PQ, PR on the circle from P (see Fig. 10.7). We are required to prove that  $PQ = PR$ .

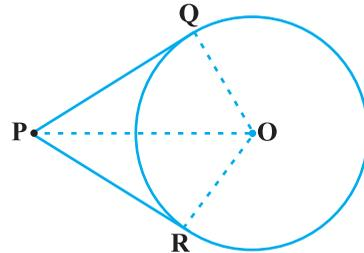
For this, we join OP, OQ and OR. Then  $\angle OQP$  and  $\angle ORP$  are right angles, because these are angles between the radii and tangents, and according to Theorem 10.1 they are right angles. Now in right triangles OQP and ORP,

$$OQ = OR \quad \text{(Radii of the same circle)}$$

$$OP = OP \quad \text{(Common)}$$

$$\text{Therefore,} \quad \Delta OQP \cong \Delta ORP \quad \text{(RHS)}$$

$$\text{This gives} \quad PQ = PR \quad \text{(CPCT)}$$



**Fig. 10.7**

**Remarks :**

1. The theorem can also be proved by using the Pythagoras Theorem as follows:

$$PQ^2 = OP^2 - OQ^2 = OP^2 - OR^2 = PR^2 \quad (\text{As } OQ = OR)$$

which gives  $PQ = PR$ .

2. Note also that  $\angle OPQ = \angle OPR$ . Therefore, OP is the angle bisector of  $\angle QPR$ , i.e., the centre lies on the bisector of the angle between the two tangents.

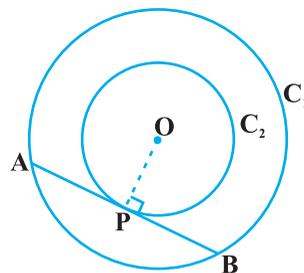
Let us take some examples.

**Example 1 :** Prove that in two concentric circles, the chord of the larger circle, which touches the smaller circle, is bisected at the point of contact.

**Solution :** We are given two concentric circles  $C_1$  and  $C_2$  with centre O and a chord AB of the larger circle  $C_1$  which touches the smaller circle  $C_2$  at the point P (see Fig. 10.8). We need to prove that  $AP = BP$ .

Let us join OP. Then, AB is a tangent to  $C_2$  at P and OP is its radius. Therefore, by Theorem 10.1,

$$OP \perp AB$$



**Fig. 10.8**

Now AB is a chord of the circle  $C_1$  and  $OP \perp AB$ . Therefore, OP is the bisector of the chord AB, as the perpendicular from the centre bisects the chord,

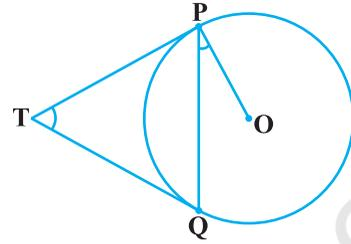
i.e.,  $AP = BP$

**Example 2 :** Two tangents TP and TQ are drawn to a circle with centre O from an external point T. Prove that  $\angle PTQ = 2 \angle OPQ$ .

**Solution :** We are given a circle with centre O, an external point T and two tangents TP and TQ to the circle, where P, Q are the points of contact (see Fig. 10.9). We need to prove that

$$\angle PTQ = 2 \angle OPQ$$

Fig. 10.9



Let  $\angle PTQ = \theta$

Now, by Theorem 10.2,  $TP = TQ$ . So,  $\triangle TPQ$  is an isosceles triangle.

Therefore,  $\angle TPQ = \angle TQP = \frac{1}{2} (180^\circ - \theta) = 90^\circ - \frac{1}{2} \theta$

Also, by Theorem 10.1,  $\angle OPT = 90^\circ$

So,  $\angle OPQ = \angle OPT - \angle TPQ = 90^\circ - \left(90^\circ - \frac{1}{2} \theta\right)$   
 $= \frac{1}{2} \theta = \frac{1}{2} \angle PTQ$

This gives  $\angle PTQ = 2 \angle OPQ$

**Example 3 :** PQ is a chord of length 8 cm of a circle of radius 5 cm. The tangents at P and Q intersect at a point T (see Fig. 10.10). Find the length TP.

**Solution :** Join OT. Let it intersect PQ at the point R. Then  $\triangle TPQ$  is isosceles and TO is the angle bisector of  $\angle PTQ$ . So,  $OT \perp PQ$  and therefore, OT bisects PQ which gives  $PR = RQ = 4$  cm.

Also,  $OR = \sqrt{OP^2 - PR^2} = \sqrt{5^2 - 4^2}$  cm = 3 cm.

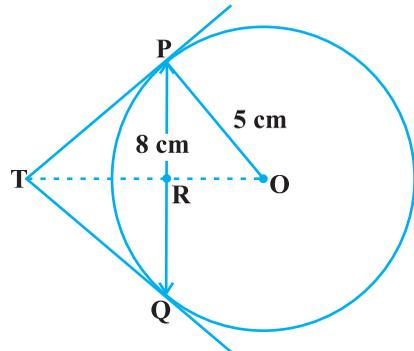


Fig. 10.10

Now,  $\angle TPR + \angle RPO = 90^\circ = \angle TPR + \angle PTR$  (Why?)

So,  $\angle RPO = \angle PTR$

Therefore, right triangle TRP is similar to the right triangle PRO by AA similarity.

This gives  $\frac{TP}{PO} = \frac{RP}{RO}$ , i.e.,  $\frac{TP}{5} = \frac{4}{3}$  or  $TP = \frac{20}{3}$  cm.

**Note :** TP can also be found by using the Pythagoras Theorem, as follows:

Let  $TP = x$  and  $TR = y$ . Then

$$x^2 = y^2 + 16 \quad (\text{Taking right } \Delta PRT) \quad (1)$$

$$x^2 + 5^2 = (y + 3)^2 \quad (\text{Taking right } \Delta OPT) \quad (2)$$

Subtracting (1) from (2), we get

$$25 = 6y - 7 \quad \text{or} \quad y = \frac{32}{6} = \frac{16}{3}$$

Therefore,  $x^2 = \left(\frac{16}{3}\right)^2 + 16 = \frac{16}{9}(16 + 9) = \frac{16 \times 25}{9}$  [From (1)]

or  $x = \frac{20}{3}$

### EXERCISE 10.2

In Q.1 to 3, choose the correct option and give justification.

- From a point Q, the length of the tangent to a circle is 24 cm and the distance of Q from the centre is 25 cm. The radius of the circle is  
 (A) 7 cm (B) 12 cm  
 (C) 15 cm (D) 24.5 cm
- In Fig. 10.11, if TP and TQ are the two tangents to a circle with centre O so that  $\angle POQ = 110^\circ$ , then  $\angle PTQ$  is equal to  
 (A)  $60^\circ$  (B)  $70^\circ$   
 (C)  $80^\circ$  (D)  $90^\circ$
- If tangents PA and PB from a point P to a circle with centre O are inclined to each other at angle of  $80^\circ$ , then  $\angle POA$  is equal to  
 (A)  $50^\circ$  (B)  $60^\circ$   
 (C)  $70^\circ$  (D)  $80^\circ$

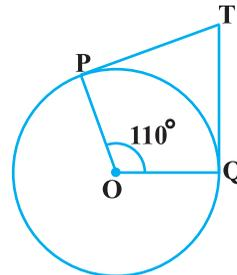


Fig. 10.11

4. Prove that the tangents drawn at the ends of a diameter of a circle are parallel.
5. Prove that the perpendicular at the point of contact to the tangent to a circle passes through the centre.
6. The length of a tangent from a point A at distance 5 cm from the centre of the circle is 4 cm. Find the radius of the circle.
7. Two concentric circles are of radii 5 cm and 3 cm. Find the length of the chord of the larger circle which touches the smaller circle.
8. A quadrilateral ABCD is drawn to circumscribe a circle (see Fig. 10.12). Prove that

$$AB + CD = AD + BC$$

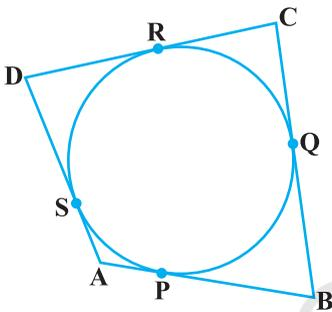


Fig. 10.12

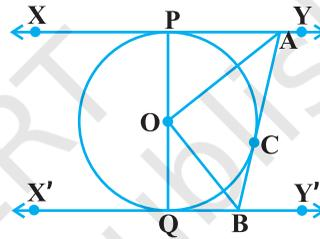


Fig. 10.13

9. In Fig. 10.13, XY and X'Y' are two parallel tangents to a circle with centre O and another tangent AB with point of contact C intersecting XY at A and X'Y' at B. Prove that  $\angle AOB = 90^\circ$ .
10. Prove that the angle between the two tangents drawn from an external point to a circle is supplementary to the angle subtended by the line-segment joining the points of contact at the centre.
11. Prove that the parallelogram circumscribing a circle is a rhombus.
12. A triangle ABC is drawn to circumscribe a circle of radius 4 cm such that the segments BD and DC into which BC is divided by the point of contact D are of lengths 8 cm and 6 cm respectively (see Fig. 10.14). Find the sides AB and AC.
13. Prove that opposite sides of a quadrilateral circumscribing a circle subtend supplementary angles at the centre of the circle.

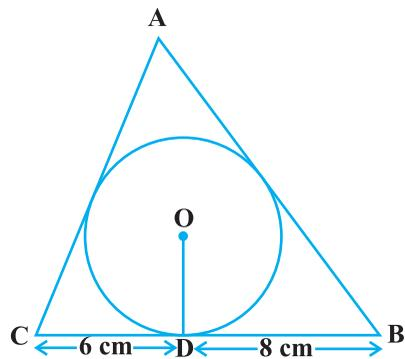


Fig. 10.14

## 10.4 Summary

In this chapter, you have studied the following points :

1. The meaning of a tangent to a circle.
2. The tangent to a circle is perpendicular to the radius through the point of contact.
3. The lengths of the two tangents from an external point to a circle are equal.

© NCERT  
not to be republished



1062CH11

# CONSTRUCTIONS

# 11

## 11.1 Introduction

In Class IX, you have done certain constructions using a straight edge (ruler) and a compass, e.g., bisecting an angle, drawing the perpendicular bisector of a line segment, some constructions of triangles etc. and also gave their justifications. In this chapter, we shall study some more constructions by using the knowledge of the earlier constructions. You would also be expected to give the mathematical reasoning behind why such constructions work.

## 11.2 Division of a Line Segment

Suppose a line segment is given and you have to divide it in a given ratio, say 3 : 2. You may do it by measuring the length and then marking a point on it that divides it in the given ratio. But suppose you do not have any way of measuring it precisely, how would you find the point? We give below two ways for finding such a point.

**Construction 11.1 :** *To divide a line segment in a given ratio.*

Given a line segment  $AB$ , we want to divide it in the ratio  $m : n$ , where both  $m$  and  $n$  are positive integers. To help you to understand it, we shall take  $m = 3$  and  $n = 2$ .

### Steps of Construction :

1. Draw any ray  $AX$ , making an acute angle with  $AB$ .
2. Locate 5 ( $= m + n$ ) points  $A_1, A_2, A_3, A_4$  and  $A_5$  on  $AX$  so that  $AA_1 = A_1A_2 = A_2A_3 = A_3A_4 = A_4A_5$ .
3. Join  $BA_5$ .
4. Through the point  $A_3$  ( $m = 3$ ), draw a line parallel to  $A_5B$  (by making an angle equal to  $\angle AA_5B$ ) at  $A_3$  intersecting  $AB$  at the point  $C$  (see Fig. 11.1). Then,  $AC : CB = 3 : 2$ .

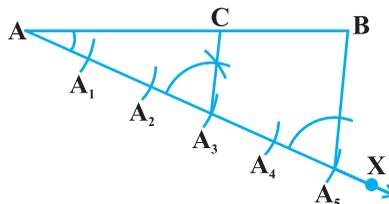


Fig. 11.1

Let us see how this method gives us the required division.

Since  $A_3C$  is parallel to  $A_5B$ , therefore,

$$\frac{AA_3}{A_3A_5} = \frac{AC}{CB} \quad (\text{By the Basic Proportionality Theorem})$$

By construction,  $\frac{AA_3}{A_3A_5} = \frac{3}{2}$ . Therefore,  $\frac{AC}{CB} = \frac{3}{2}$ .

This shows that C divides AB in the ratio 3 : 2.

### Alternative Method

#### Steps of Construction :

1. Draw any ray AX making an acute angle with AB.
2. Draw a ray BY parallel to AX by making  $\angle ABY$  equal to  $\angle BAX$ .
3. Locate the points  $A_1, A_2, A_3$  ( $m = 3$ ) on AX and  $B_1, B_2$  ( $n = 2$ ) on BY such that  $AA_1 = A_1A_2 = A_2A_3 = BB_1 = B_1B_2$ .
4. Join  $A_3B_2$ . Let it intersect AB at a point C (see Fig. 11.2).

Then  $AC : CB = 3 : 2$ .

Why does this method work? Let us see.

Here  $\Delta AA_3C$  is similar to  $\Delta BB_2C$ . (Why ?)

Then 
$$\frac{AA_3}{BB_2} = \frac{AC}{BC}$$

Since by construction,  $\frac{AA_3}{BB_2} = \frac{3}{2}$ , therefore,  $\frac{AC}{BC} = \frac{3}{2}$ .

In fact, the methods given above work for dividing the line segment in any ratio.

We now use the idea of the construction above for constructing a triangle similar to a given triangle whose sides are in a given ratio with the corresponding sides of the given triangle.

**Construction 11.2 :** To construct a triangle similar to a given triangle as per given scale factor.

This construction involves two different situations. In one, the triangle to be constructed is smaller and in the other it is larger than the given triangle. Here, the **scale factor** means the ratio of the sides of the triangle to be constructed with the corresponding sides of the given triangle (see also Chapter 6). Let us take the following examples for understanding the constructions involved. **The same methods would apply for the general case also.**

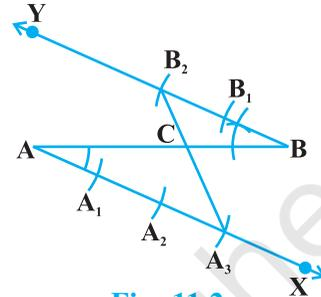


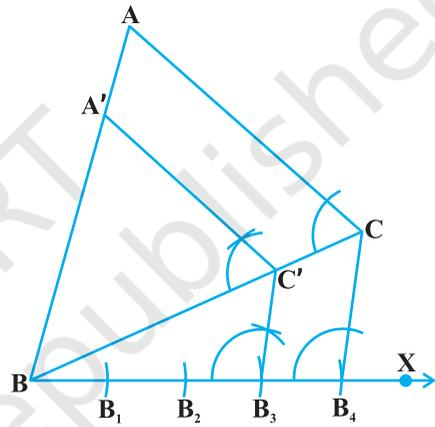
Fig. 11.2

**Example 1 :** Construct a triangle similar to a given triangle ABC with its sides equal to  $\frac{3}{4}$  of the corresponding sides of the triangle ABC (i.e., of scale factor  $\frac{3}{4}$ ).

**Solution :** Given a triangle ABC, we are required to construct another triangle whose sides are  $\frac{3}{4}$  of the corresponding sides of the triangle ABC.

**Steps of Construction :**

1. Draw any ray BX making an acute angle with BC on the side opposite to the vertex A.
2. Locate 4 (the greater of 3 and 4 in  $\frac{3}{4}$ ) points  $B_1, B_2, B_3$  and  $B_4$  on BX so that  $BB_1 = B_1B_2 = B_2B_3 = B_3B_4$ .
3. Join  $B_4C$  and draw a line through  $B_3$  (the 3rd point, 3 being smaller of 3 and 4 in  $\frac{3}{4}$ ) parallel to  $B_4C$  to intersect BC at  $C'$ .
4. Draw a line through  $C'$  parallel to the line CA to intersect BA at  $A'$  (see Fig. 11.3).



**Fig. 11.3**

Then,  $\Delta A'BC'$  is the required triangle.

Let us now see how this construction gives the required triangle.

By Construction 11.1,  $\frac{BC'}{C'C} = \frac{3}{1}$ .

Therefore,  $\frac{BC}{BC'} = \frac{BC' + C'C}{BC'} = 1 + \frac{C'C}{BC'} = 1 + \frac{1}{3} = \frac{4}{3}$ , i.e.,  $\frac{BC'}{BC} = \frac{3}{4}$ .

Also  $C'A'$  is parallel to CA. Therefore,  $\Delta A'BC' \sim \Delta ABC$ . (Why ?)

So,  $\frac{A'B}{AB} = \frac{A'C'}{AC} = \frac{BC'}{BC} = \frac{3}{4}$ .

**Example 2 :** Construct a triangle similar to a given triangle ABC with its sides equal to  $\frac{5}{3}$  of the corresponding sides of the triangle ABC (i.e., of scale factor  $\frac{5}{3}$ ).

**Solution :** Given a triangle ABC, we are required to construct a triangle whose sides are  $\frac{5}{3}$  of the corresponding sides of  $\Delta ABC$ .

**Steps of Construction :**

1. Draw any ray BX making an acute angle with BC on the side opposite to the vertex A.
2. Locate 5 points (the greater of 5 and 3 in  $\frac{5}{3}$ )  $B_1, B_2, B_3, B_4$  and  $B_5$  on BX so that  $BB_1 = B_1B_2 = B_2B_3 = B_3B_4 = B_4B_5$ .
3. Join  $B_3$  (the 3rd point, 3 being smaller of 3 and 5 in  $\frac{5}{3}$ ) to C and draw a line through  $B_5$  parallel to  $B_3C$ , intersecting the extended line segment BC at  $C'$ .
4. Draw a line through  $C'$  parallel to CA intersecting the extended line segment BA at  $A'$  (see Fig. 11.4).

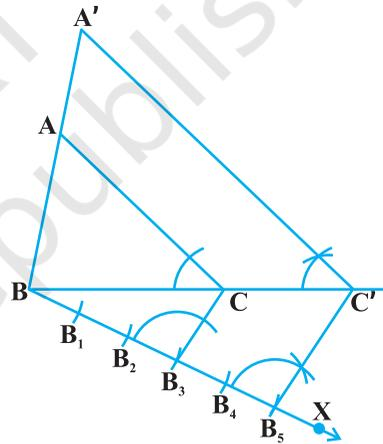
Then  $A'BC'$  is the required triangle.

For justification of the construction, note that  $\Delta ABC \sim \Delta A'BC'$ . (Why ?)

$$\text{Therefore, } \frac{AB}{A'B} = \frac{AC}{A'C'} = \frac{BC}{BC'}$$

$$\text{But, } \frac{BC}{BC'} = \frac{BB_3}{BB_5} = \frac{3}{5}$$

$$\text{So, } \frac{BC'}{BC} = \frac{5}{3}, \text{ and, therefore, } \frac{A'B}{AB} = \frac{A'C'}{AC} = \frac{BC'}{BC} = \frac{5}{3}$$



**Fig. 11.4**

**Remark :** In Examples 1 and 2, you could take a ray making an acute angle with AB or AC and proceed similarly.

**EXERCISE 11.1**

In each of the following, give the justification of the construction also:

1. Draw a line segment of length 7.6 cm and divide it in the ratio 5 : 8. Measure the two parts.

2. Construct a triangle of sides 4 cm, 5 cm and 6 cm and then a triangle similar to it whose sides are  $\frac{2}{3}$  of the corresponding sides of the first triangle.
3. Construct a triangle with sides 5 cm, 6 cm and 7 cm and then another triangle whose sides are  $\frac{7}{5}$  of the corresponding sides of the first triangle.
4. Construct an isosceles triangle whose base is 8 cm and altitude 4 cm and then another triangle whose sides are  $1\frac{1}{2}$  times the corresponding sides of the isosceles triangle.
5. Draw a triangle ABC with side BC = 6 cm, AB = 5 cm and  $\angle ABC = 60^\circ$ . Then construct a triangle whose sides are  $\frac{3}{4}$  of the corresponding sides of the triangle ABC.
6. Draw a triangle ABC with side BC = 7 cm,  $\angle B = 45^\circ$ ,  $\angle A = 105^\circ$ . Then, construct a triangle whose sides are  $\frac{4}{3}$  times the corresponding sides of  $\triangle ABC$ .
7. Draw a right triangle in which the sides (other than hypotenuse) are of lengths 4 cm and 3 cm. Then construct another triangle whose sides are  $\frac{5}{3}$  times the corresponding sides of the given triangle.

### 11.3 Construction of Tangents to a Circle

You have already studied in the previous chapter that if a point lies inside a circle, there cannot be a tangent to the circle through this point. However, if a point lies on the circle, then there is only one tangent to the circle at this point and it is perpendicular to the radius through this point. Therefore, if you want to draw a tangent at a point of a circle, simply draw the radius through this point and draw a line perpendicular to this radius through this point and this will be the required tangent at the point.

You have also seen that if the point lies outside the circle, there will be two tangents to the circle from this point.

We shall now see how to draw these tangents.

**Construction 11.3 :** *To construct the tangents to a circle from a point outside it.*

We are given a circle with centre O and a point P outside it. We have to construct the two tangents from P to the circle.

**Steps of Construction:**

1. Join PO and bisect it. Let M be the mid-point of PO.
2. Taking M as centre and MO as radius, draw a circle. Let it intersect the given circle at the points Q and R.
3. Join PQ and PR.

Then PQ and PR are the required two tangents (see Fig. 11.5).

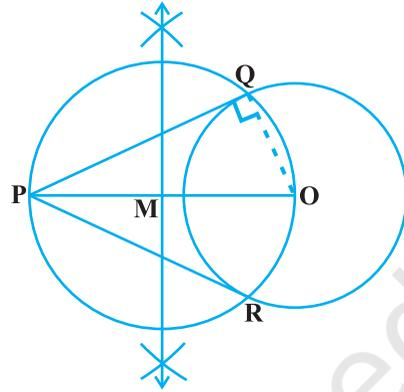
Now let us see how this construction works. Join OQ. Then  $\angle PQO$  is an angle in the semicircle and, therefore,

$$\angle PQO = 90^\circ$$

Can we say that  $PQ \perp OQ$ ?

Since, OQ is a radius of the given circle, PQ has to be a tangent to the circle. Similarly, PR is also a tangent to the circle.

**Note :** If centre of the circle is not given, you may locate its centre first by taking any two non-parallel chords and then finding the point of intersection of their perpendicular bisectors. Then you could proceed as above.



**Fig. 11.5**

### EXERCISE 11.2

In each of the following, give also the justification of the construction:

1. Draw a circle of radius 6 cm. From a point 10 cm away from its centre, construct the pair of tangents to the circle and measure their lengths.
2. Construct a tangent to a circle of radius 4 cm from a point on the concentric circle of radius 6 cm and measure its length. Also verify the measurement by actual calculation.
3. Draw a circle of radius 3 cm. Take two points P and Q on one of its extended diameter each at a distance of 7 cm from its centre. Draw tangents to the circle from these two points P and Q.
4. Draw a pair of tangents to a circle of radius 5 cm which are inclined to each other at an angle of  $60^\circ$ .
5. Draw a line segment AB of length 8 cm. Taking A as centre, draw a circle of radius 4 cm and taking B as centre, draw another circle of radius 3 cm. Construct tangents to each circle from the centre of the other circle.

6. Let ABC be a right triangle in which  $AB = 6$  cm,  $BC = 8$  cm and  $\angle B = 90^\circ$ . BD is the perpendicular from B on AC. The circle through B, C, D is drawn. Construct the tangents from A to this circle.
7. Draw a circle with the help of a bangle. Take a point outside the circle. Construct the pair of tangents from this point to the circle.

### 11.4 Summary

In this chapter, you have learnt how to do the following constructions:

1. To divide a line segment in a given ratio.
2. To construct a triangle similar to a given triangle as per a given scale factor which may be less than 1 or greater than 1.
3. To construct the pair of tangents from an external point to a circle.

#### A NOTE TO THE READER

Construction of a quadrilateral (or a polygon) similar to a given quadrilateral (or a polygon) with a given scale factor can also be done following the similar steps as used in Examples 1 and 2 of Construction 11.2.



1062CH12

# AREAS RELATED TO CIRCLES

# 12

## 12.1 Introduction

You are already familiar with some methods of finding perimeters and areas of simple plane figures such as rectangles, squares, parallelograms, triangles and circles from your earlier classes. Many objects that we come across in our daily life are related to the circular shape in some form or the other. Cycle wheels, wheel barrow (*thela*), dartboard, round cake, *papad*, drain cover, various designs, bangles, brooches, circular paths, washers, flower beds, etc. are some examples of such objects (see Fig. 12.1). So, the problem of finding perimeters and areas related to circular figures is of great practical importance. In this chapter, we shall begin our discussion with a review of the concepts of perimeter (circumference) and area of a circle and apply this knowledge in finding the areas of two special ‘parts’ of a circular region (or briefly of a circle) known as *sector* and *segment*. We shall also see how to find the areas of some combinations of plane figures involving circles or their parts.

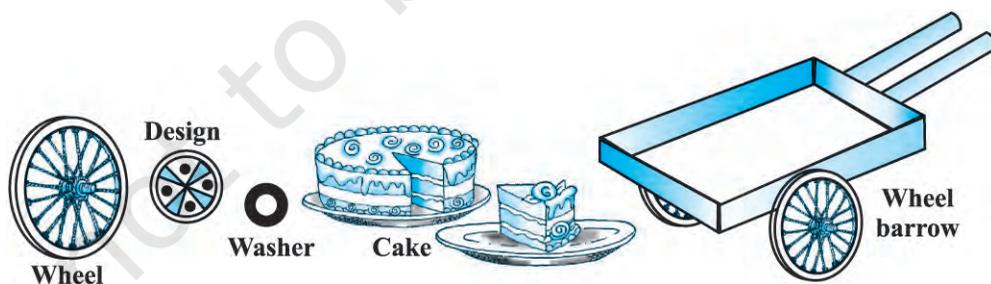


Fig. 12.1

## 12.2 Perimeter and Area of a Circle — A Review

Recall that the distance covered by travelling once around a circle is its *perimeter*, usually called its *circumference*. You also know from your earlier classes, that circumference of a circle bears a constant ratio with its diameter. This constant ratio is denoted by the Greek letter  $\pi$  (read as ‘pi’). In other words,

$$\frac{\text{circumference}}{\text{diameter}} = \pi$$

or,

$$\begin{aligned} \text{circumference} &= \pi \times \text{diameter} \\ &= \pi \times 2r \quad (\text{where } r \text{ is the radius of the circle}) \\ &= 2\pi r \end{aligned}$$

The great Indian mathematician Aryabhata (C.E. 476 – 550) gave an approximate

value of  $\pi$ . He stated that  $\pi = \frac{62832}{20000}$ , which is nearly equal to 3.1416. It is also

interesting to note that using an identity of the great mathematical genius Srinivas Ramanujan (1887–1920) of India, mathematicians have been able to calculate the value of  $\pi$  correct to million places of decimals. As you know from Chapter 1 of Class IX,  $\pi$  is an irrational number and its decimal expansion is non-terminating and non-recurring (non-repeating). However, for practical purposes, we generally take

the value of  $\pi$  as  $\frac{22}{7}$  or 3.14, approximately.

You may also recall that area of a circle is  $\pi r^2$ , where  $r$  is the radius of the circle. Recall that you have verified it in Class VII, by cutting a circle into a number of sectors and rearranging them as shown in Fig. 12.2.

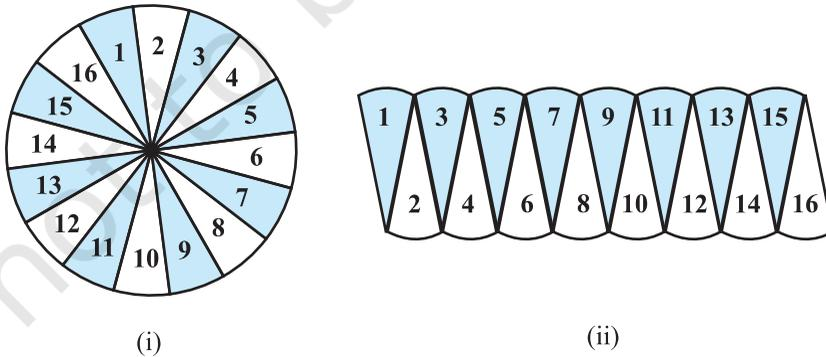


Fig 12.2

You can see that the shape in Fig. 12.2 (ii) is nearly a rectangle of length  $\frac{1}{2} \times 2\pi r$  and breadth  $r$ . This suggests that the area of the circle =  $\frac{1}{2} \times 2\pi r \times r = \pi r^2$ . Let us recall the concepts learnt in earlier classes, through an example.

**Example 1 :** The cost of fencing a circular field at the rate of ₹ 24 per metre is ₹ 5280. The field is to be ploughed at the rate of ₹ 0.50 per  $m^2$ . Find the cost of ploughing the field (Take  $\pi = \frac{22}{7}$ ).

**Solution :** Length of the fence (in metres) =  $\frac{\text{Total cost}}{\text{Rate}} = \frac{5280}{24} = 220$   
 So, circumference of the field = 220 m

Therefore, if  $r$  metres is the radius of the field, then

$$2\pi r = 220$$

or,  $2 \times \frac{22}{7} \times r = 220$

or,  $r = \frac{220 \times 7}{2 \times 22} = 35$

i.e., radius of the field is 35 m.

Therefore, area of the field =  $\pi r^2 = \frac{22}{7} \times 35 \times 35 m^2 = 22 \times 5 \times 35 m^2$

Now, cost of ploughing 1  $m^2$  of the field = ₹ 0.50

So, total cost of ploughing the field = ₹  $22 \times 5 \times 35 \times 0.50 = ₹ 1925$

### EXERCISE 12.1

Unless stated otherwise, use  $\pi = \frac{22}{7}$ .

- The radii of two circles are 19 cm and 9 cm respectively. Find the radius of the circle which has circumference equal to the sum of the circumferences of the two circles.
- The radii of two circles are 8 cm and 6 cm respectively. Find the radius of the circle having area equal to the sum of the areas of the two circles.
- Fig. 12.3 depicts an archery target marked with its five scoring regions from the centre outwards as Gold, Red, Blue, Black and White. The diameter of the region representing Gold score is 21 cm and each of the other bands is 10.5 cm wide. Find the area of each of the five scoring regions.

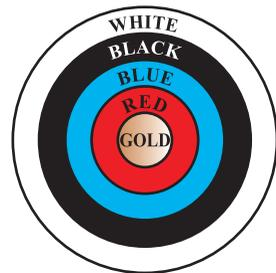


Fig. 12.3

4. The wheels of a car are of diameter 80 cm each. How many complete revolutions does each wheel make in 10 minutes when the car is travelling at a speed of 66 km per hour?
5. Tick the correct answer in the following and justify your choice : If the perimeter and the area of a circle are numerically equal, then the radius of the circle is
- (A) 2 units                      (B)  $\pi$  units                      (C) 4 units                      (D) 7 units

### 12.3 Areas of Sector and Segment of a Circle

You have already come across the terms *sector* and *segment* of a circle in your earlier classes. Recall that the portion (or part) of the circular region enclosed by two radii and the corresponding arc is called a *sector* of the circle and the portion (or part) of the circular region enclosed between a chord and the corresponding arc is called a *segment* of the circle. Thus, in Fig. 12.4, shaded region OAPB is a *sector* of the circle with centre O.  $\angle AOB$  is called the *angle* of the sector. Note that in this figure, unshaded region OAQB is also a sector of the circle. For obvious reasons, OAPB is called the *minor sector* and OAQB is called the *major sector*. You can also see that angle of the major sector is  $360^\circ - \angle AOB$ .

Now, look at Fig. 12.5 in which AB is a chord of the circle with centre O. So, shaded region APB is a segment of the circle. You can also note that unshaded region AQB is another segment of the circle formed by the chord AB. For obvious reasons, APB is called the *minor segment* and AQB is called the *major segment*.

**Remark :** When we write ‘segment’ and ‘sector’ we will mean the ‘minor segment’ and the ‘minor sector’ respectively, unless stated otherwise.

Now with this knowledge, let us try to find some relations (or formulae) to calculate their areas.

Let OAPB be a sector of a circle with centre O and radius  $r$  (see Fig. 12.6). Let the degree measure of  $\angle AOB$  be  $\theta$ .

You know that area of a circle (in fact of a circular region or disc) is  $\pi r^2$ .

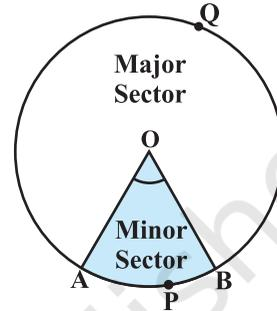


Fig. 12.4

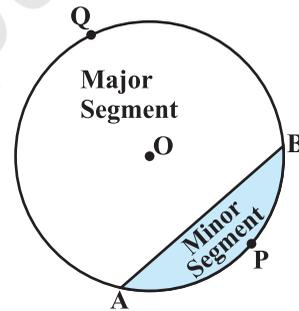


Fig. 12.5

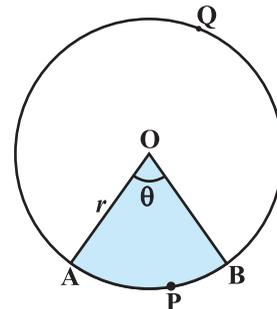


Fig. 12.6

In a way, we can consider this circular region to be a sector forming an angle of  $360^\circ$  (i.e., of degree measure 360) at the centre O. Now by applying the Unitary Method, we can arrive at the area of the sector OAPB as follows:

When degree measure of the angle at the centre is 360, area of the sector =  $\pi r^2$

So, when the degree measure of the angle at the centre is 1, area of the sector =  $\frac{\pi r^2}{360}$ .

Therefore, when the degree measure of the angle at the centre is  $\theta$ , area of the sector =  $\frac{\pi r^2}{360} \times \theta = \frac{\theta}{360} \times \pi r^2$ .

Thus, we obtain the following relation (or formula) for area of a sector of a circle:

$$\text{Area of the sector of angle } \theta = \frac{\theta}{360} \times \pi r^2,$$

where  $r$  is the radius of the circle and  $\theta$  the angle of the sector in degrees.

Now, a natural question arises : Can we find the length of the arc APB corresponding to this sector? Yes. Again, by applying the Unitary Method and taking the whole length of the circle (of angle  $360^\circ$ ) as  $2\pi r$ , we can obtain the required length of the arc APB as  $\frac{\theta}{360} \times 2\pi r$ .

So, length of an arc of a sector of angle  $\theta = \frac{\theta}{360} \times 2\pi r$ .

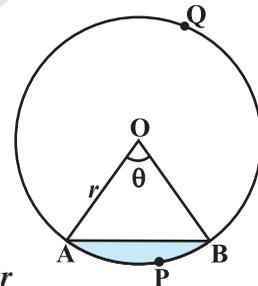


Fig. 12.7

Now let us take the case of the area of the segment APB of a circle with centre O and radius  $r$  (see Fig. 12.7). You can see that :

$$\begin{aligned} \text{Area of the segment APB} &= \text{Area of the sector OAPB} - \text{Area of } \Delta \text{OAB} \\ &= \frac{\theta}{360} \times \pi r^2 - \text{area of } \Delta \text{OAB} \end{aligned}$$

**Note :** From Fig. 12.6 and Fig. 12.7 respectively, you can observe that :

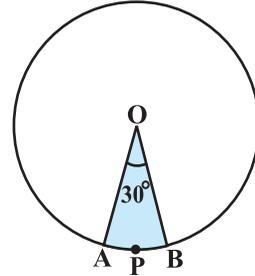
Area of the major sector OAQB =  $\pi r^2 - \text{Area of the minor sector OAPB}$   
 and Area of major segment AQB =  $\pi r^2 - \text{Area of the minor segment APB}$

Let us now take some examples to understand these concepts (or results).

**Example 2 :** Find the area of the sector of a circle with radius 4 cm and of angle  $30^\circ$ . Also, find the area of the corresponding major sector (Use  $\pi = 3.14$ ).

**Solution :** Given sector is OAPB (see Fig. 12.8).

$$\begin{aligned} \text{Area of the sector} &= \frac{\theta}{360} \times \pi r^2 \\ &= \frac{30}{360} \times 3.14 \times 4 \times 4 \text{ cm}^2 \\ &= \frac{12.56}{3} \text{ cm}^2 = 4.19 \text{ cm}^2 \text{ (approx.)} \end{aligned}$$



**Fig. 12.8**

Area of the corresponding major sector

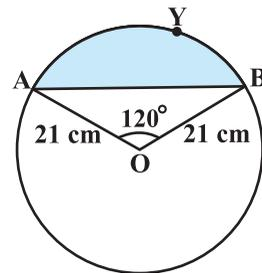
$$\begin{aligned} &= \pi r^2 - \text{area of sector OAPB} \\ &= (3.14 \times 16 - 4.19) \text{ cm}^2 \\ &= 46.05 \text{ cm}^2 = 46.1 \text{ cm}^2 \text{ (approx.)} \end{aligned}$$

**Alternatively,** area of the major sector =  $\frac{(360 - \theta)}{360} \times \pi r^2$

$$\begin{aligned} &= \left( \frac{360 - 30}{360} \right) \times 3.14 \times 16 \text{ cm}^2 \\ &= \frac{330}{360} \times 3.14 \times 16 \text{ cm}^2 = 46.05 \text{ cm}^2 \\ &= 46.1 \text{ cm}^2 \text{ (approx.)} \end{aligned}$$

**Example 3 :** Find the area of the segment AYB shown in Fig. 12.9, if radius of the circle is 21 cm and

$\angle AOB = 120^\circ$ . (Use  $\pi = \frac{22}{7}$ )



**Fig. 12.9**

**Solution :** Area of the segment AYB

$$= \text{Area of sector OAYB} - \text{Area of } \Delta \text{ OAB} \quad (1)$$

$$\text{Now, area of the sector OAYB} = \frac{120}{360} \times \frac{22}{7} \times 21 \times 21 \text{ cm}^2 = 462 \text{ cm}^2 \quad (2)$$

For finding the area of  $\Delta \text{ OAB}$ , draw  $\text{OM} \perp \text{AB}$  as shown in Fig. 12.10.

Note that  $\text{OA} = \text{OB}$ . Therefore, by RHS congruence,  $\Delta \text{AMO} \cong \Delta \text{BMO}$ .

So, M is the mid-point of AB and  $\angle \text{AOM} = \angle \text{BOM} = \frac{1}{2} \times 120^\circ = 60^\circ$ .

Let  $\text{OM} = x \text{ cm}$

So, from  $\Delta \text{OMA}$ ,  $\frac{\text{OM}}{\text{OA}} = \cos 60^\circ$

$$\text{or, } \frac{x}{21} = \frac{1}{2} \quad \left( \cos 60^\circ = \frac{1}{2} \right)$$

$$\text{or, } x = \frac{21}{2}$$

$$\text{So, } \text{OM} = \frac{21}{2} \text{ cm}$$

$$\text{Also, } \frac{\text{AM}}{\text{OA}} = \sin 60^\circ = \frac{\sqrt{3}}{2}$$

$$\text{So, } \text{AM} = \frac{21\sqrt{3}}{2} \text{ cm}$$

$$\text{Therefore, } \text{AB} = 2 \text{AM} = \frac{2 \times 21\sqrt{3}}{2} \text{ cm} = 21\sqrt{3} \text{ cm}$$

$$\begin{aligned} \text{So, area of } \Delta \text{ OAB} &= \frac{1}{2} \text{AB} \times \text{OM} = \frac{1}{2} \times 21\sqrt{3} \times \frac{21}{2} \text{ cm}^2 \\ &= \frac{441}{4} \sqrt{3} \text{ cm}^2 \end{aligned} \quad (3)$$

$$\text{Therefore, area of the segment AYB} = \left( 462 - \frac{441}{4} \sqrt{3} \right) \text{ cm}^2 \text{ [From (1), (2) and (3)]}$$

$$= \frac{21}{4} (88 - 21\sqrt{3}) \text{ cm}^2$$

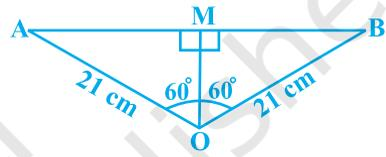


Fig. 12.10

### EXERCISE 12.2

Unless stated otherwise, use  $\pi = \frac{22}{7}$ .

- Find the area of a sector of a circle with radius 6 cm if angle of the sector is  $60^\circ$ .
- Find the area of a quadrant of a circle whose circumference is 22 cm.
- The length of the minute hand of a clock is 14 cm. Find the area swept by the minute hand in 5 minutes.
- A chord of a circle of radius 10 cm subtends a right angle at the centre. Find the area of the corresponding : (i) minor segment (ii) major sector. (Use  $\pi = 3.14$ )
- In a circle of radius 21 cm, an arc subtends an angle of  $60^\circ$  at the centre. Find:
  - the length of the arc
  - area of the sector formed by the arc
  - area of the segment formed by the corresponding chord
- A chord of a circle of radius 15 cm subtends an angle of  $60^\circ$  at the centre. Find the areas of the corresponding minor and major segments of the circle. (Use  $\pi = 3.14$  and  $\sqrt{3} = 1.73$ )
- A chord of a circle of radius 12 cm subtends an angle of  $120^\circ$  at the centre. Find the area of the corresponding segment of the circle. (Use  $\pi = 3.14$  and  $\sqrt{3} = 1.73$ )
- A horse is tied to a peg at one corner of a square shaped grass field of side 15 m by means of a 5 m long rope (see Fig. 12.11). Find
  - the area of that part of the field in which the horse can graze.
  - the increase in the grazing area if the rope were 10 m long instead of 5 m. (Use  $\pi = 3.14$ )
- A brooch is made with silver wire in the form of a circle with diameter 35 mm. The wire is also used in making 5 diameters which divide the circle into 10 equal sectors as shown in Fig. 12.12. Find :
  - the total length of the silver wire required.
  - the area of each sector of the brooch.

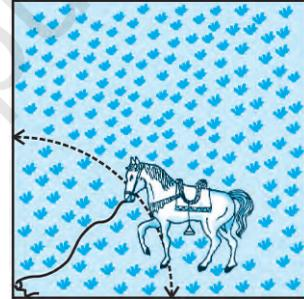


Fig. 12.11

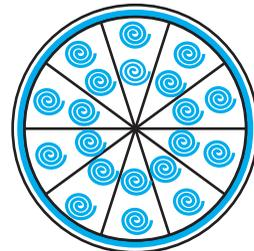


Fig. 12.12

10. An umbrella has 8 ribs which are equally spaced (see Fig. 12.13). Assuming umbrella to be a flat circle of radius 45 cm, find the area between the two consecutive ribs of the umbrella.
11. A car has two wipers which do not overlap. Each wiper has a blade of length 25 cm sweeping through an angle of  $115^\circ$ . Find the total area cleaned at each sweep of the blades.
12. To warn ships for underwater rocks, a lighthouse spreads a red coloured light over a sector of angle  $80^\circ$  to a distance of 16.5 km. Find the area of the sea over which the ships are warned. (Use  $\pi = 3.14$ )
13. A round table cover has six equal designs as shown in Fig. 12.14. If the radius of the cover is 28 cm, find the cost of making the designs at the rate of ₹ 0.35 per  $\text{cm}^2$ . (Use  $\sqrt{3} = 1.7$ )
14. Tick the correct answer in the following :

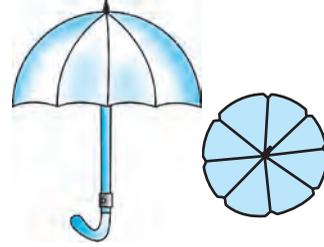


Fig. 12.13

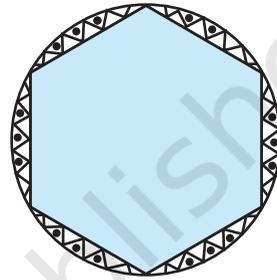


Fig. 12.14

Area of a sector of angle  $p$  (in degrees) of a circle with radius  $R$  is

- (A)  $\frac{p}{180} \times 2\pi R$       (B)  $\frac{p}{180} \times \pi R^2$       (C)  $\frac{p}{360} \times 2\pi R$       (D)  $\frac{p}{720} \times 2\pi R^2$

### 12.4 Areas of Combinations of Plane Figures

So far, we have calculated the areas of different figures separately. Let us now try to calculate the areas of some combinations of plane figures. We come across these types of figures in our daily life and also in the form of various interesting designs. Flower beds, drain covers, window designs, designs on table covers, are some of such examples. We illustrate the process of calculating areas of these figures through some examples.

**Example 4 :** In Fig. 12.15, two circular flower beds have been shown on two sides of a square lawn ABCD of side 56 m. If the centre of each circular flower bed is the point of intersection  $O$  of the diagonals of the square lawn, find the sum of the areas of the lawn and the flower beds.

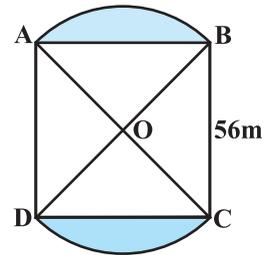


Fig. 12.15

**Solution :** Area of the square lawn ABCD =  $56 \times 56 \text{ m}^2$  (1)

Let OA = OB =  $x$  metres

So,  $x^2 + x^2 = 56^2$

or,  $2x^2 = 56 \times 56$

or,  $x^2 = 28 \times 56$  (2)

Now, area of sector OAB =  $\frac{90}{360} \times \pi x^2 = \frac{1}{4} \times \pi x^2$   
 $= \frac{1}{4} \times \frac{22}{7} \times 28 \times 56 \text{ m}^2$  [From (2)] (3)

Also, area of  $\Delta$  OAB =  $\frac{1}{4} \times 56 \times 56 \text{ m}^2$  ( $\angle$  AOB =  $90^\circ$ ) (4)

So, area of flower bed AB =  $\left( \frac{1}{4} \times \frac{22}{7} \times 28 \times 56 - \frac{1}{4} \times 56 \times 56 \right) \text{ m}^2$   
 [From (3) and (4)]  
 $= \frac{1}{4} \times 28 \times 56 \left( \frac{22}{7} - 2 \right) \text{ m}^2$   
 $= \frac{1}{4} \times 28 \times 56 \times \frac{8}{7} \text{ m}^2$  (5)

Similarly, area of the other flower bed

$$= \frac{1}{4} \times 28 \times 56 \times \frac{8}{7} \text{ m}^2 \quad (6)$$

Therefore, total area =  $\left( 56 \times 56 + \frac{1}{4} \times 28 \times 56 \times \frac{8}{7} \right.$   
 $\left. + \frac{1}{4} \times 28 \times 56 \times \frac{8}{7} \right) \text{ m}^2$  [From (1), (5) and (6)]  
 $= 28 \times 56 \left( 2 + \frac{2}{7} + \frac{2}{7} \right) \text{ m}^2$   
 $= 28 \times 56 \times \frac{18}{7} \text{ m}^2 = 4032 \text{ m}^2$

**Alternative Solution :**

$$\begin{aligned}
 \text{Total area} &= \text{Area of sector OAB} + \text{Area of sector ODC} \\
 &\quad + \text{Area of } \triangle \text{OAD} + \text{Area of } \triangle \text{OBC} \\
 &= \left( \frac{90}{360} \times \frac{22}{7} \times 28 \times 56 + \frac{90}{360} \times \frac{22}{7} \times 28 \times 56 \right. \\
 &\quad \left. + \frac{1}{4} \times 56 \times 56 + \frac{1}{4} \times 56 \times 56 \right) \text{m}^2 \\
 &= \frac{1}{4} \times 28 \times 56 \left( \frac{22}{7} + \frac{22}{7} + 2 + 2 \right) \text{m}^2 \\
 &= \frac{7 \times 56}{7} (22 + 22 + 14 + 14) \text{m}^2 \\
 &= 56 \times 72 \text{ m}^2 = 4032 \text{ m}^2
 \end{aligned}$$

**Example 5 :** Find the area of the shaded region in Fig. 12.16, where ABCD is a square of side 14 cm.

**Solution :** Area of square ABCD

$$= 14 \times 14 \text{ cm}^2 = 196 \text{ cm}^2$$

$$\text{Diameter of each circle} = \frac{14}{2} \text{ cm} = 7 \text{ cm}$$

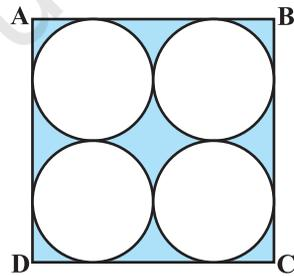
So, radius of each circle =  $\frac{7}{2}$  cm

So, area of one circle =  $\pi r^2 = \frac{22}{7} \times \frac{7}{2} \times \frac{7}{2} \text{ cm}^2$

$$= \frac{154}{4} \text{ cm} = \frac{77}{2} \text{ cm}^2$$

Therefore, area of the four circles =  $4 \times \frac{77}{2} \text{ cm}^2 = 154 \text{ cm}^2$

Hence, area of the shaded region =  $(196 - 154) \text{ cm}^2 = 42 \text{ cm}^2$ .



**Fig. 12.16**

**Example 6 :** Find the area of the shaded design in Fig. 12.17, where ABCD is a square of side 10 cm and semicircles are drawn with each side of the square as diameter. (Use  $\pi = 3.14$ )

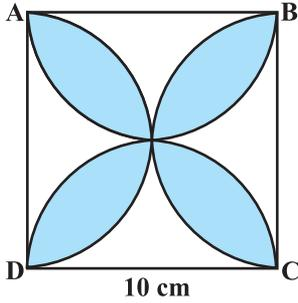


Fig. 12.17

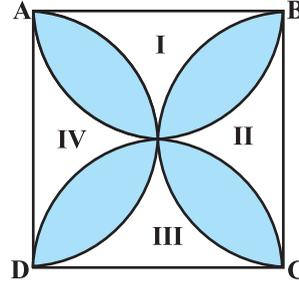


Fig. 12.18

**Solution :** Let us mark the four unshaded regions as I, II, III and IV (see Fig. 12.18).

Area of I + Area of III

$$\begin{aligned} &= \text{Area of ABCD} - \text{Areas of two semicircles of each of radius 5 cm} \\ &= \left( 10 \times 10 - 2 \times \frac{1}{2} \times \pi \times 5^2 \right) \text{cm}^2 = (100 - 3.14 \times 25) \text{cm}^2 \\ &= (100 - 78.5) \text{cm}^2 = 21.5 \text{cm}^2 \end{aligned}$$

Similarly, Area of II + Area of IV = 21.5 cm<sup>2</sup>

So, area of the shaded design = Area of ABCD – Area of (I + II + III + IV)

$$= (100 - 2 \times 21.5) \text{cm}^2 = (100 - 43) \text{cm}^2 = 57 \text{cm}^2$$

### EXERCISE 12.3

Unless stated otherwise, use  $\pi = \frac{22}{7}$ .

- Find the area of the shaded region in Fig. 12.19, if PQ = 24 cm, PR = 7 cm and O is the centre of the circle.

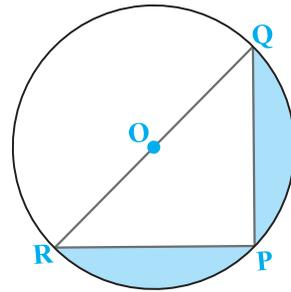


Fig. 12.19

2. Find the area of the shaded region in Fig. 12.20, if radii of the two concentric circles with centre O are 7 cm and 14 cm respectively and  $\angle AOC = 40^\circ$ .

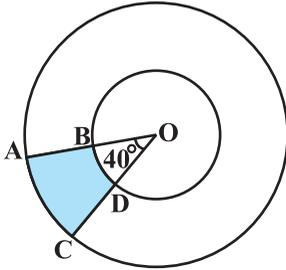


Fig. 12.20

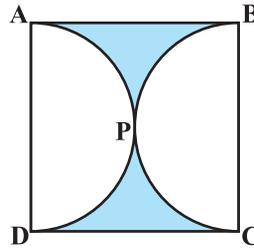


Fig. 12.21

3. Find the area of the shaded region in Fig. 12.21, if ABCD is a square of side 14 cm and APD and BPC are semicircles.
4. Find the area of the shaded region in Fig. 12.22, where a circular arc of radius 6 cm has been drawn with vertex O of an equilateral triangle OAB of side 12 cm as centre.

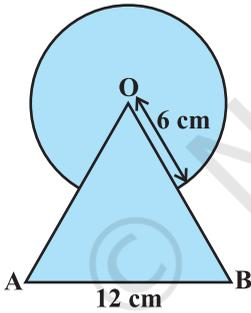


Fig. 12.22

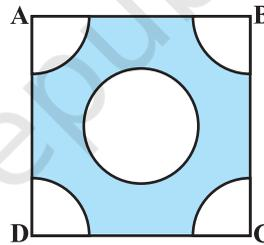


Fig. 12.23

5. From each corner of a square of side 4 cm a quadrant of a circle of radius 1 cm is cut and also a circle of diameter 2 cm is cut as shown in Fig. 12.23. Find the area of the remaining portion of the square.
6. In a circular table cover of radius 32 cm, a design is formed leaving an equilateral triangle ABC in the middle as shown in Fig. 12.24. Find the area of the design.

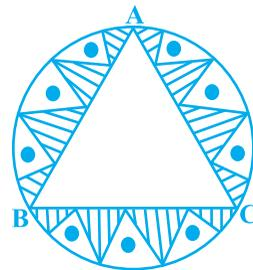


Fig. 12.24

7. In Fig. 12.25, ABCD is a square of side 14 cm. With centres A, B, C and D, four circles are drawn such that each circle touch externally two of the remaining three circles. Find the area of the shaded region.

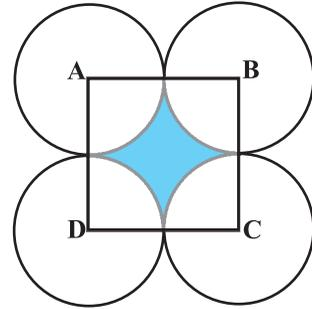


Fig. 12.25

8. Fig. 12.26 depicts a racing track whose left and right ends are semicircular.

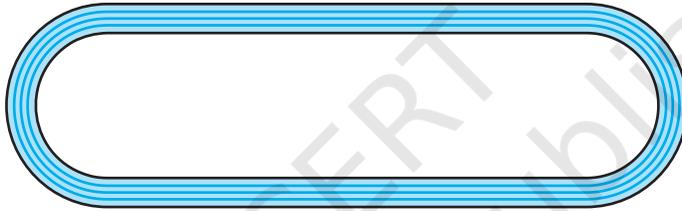


Fig. 12.26

The distance between the two inner parallel line segments is 60 m and they are each 106 m long. If the track is 10 m wide, find :

- the distance around the track along its inner edge
  - the area of the track.
9. In Fig. 12.27, AB and CD are two diameters of a circle (with centre O) perpendicular to each other and OD is the diameter of the smaller circle. If  $OA = 7$  cm, find the area of the shaded region.
10. The area of an equilateral triangle ABC is  $17320.5 \text{ cm}^2$ . With each vertex of the triangle as centre, a circle is drawn with radius equal to half the length of the side of the triangle (see Fig. 12.28). Find the area of the shaded region. (Use  $\pi = 3.14$  and  $\sqrt{3} = 1.73205$ )

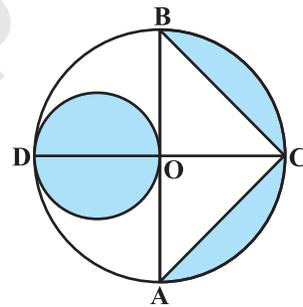


Fig. 12.27

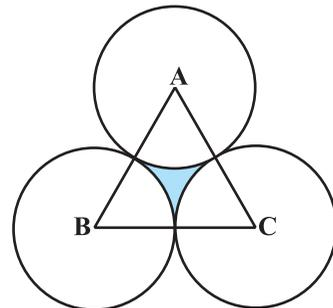


Fig. 12.28

11. On a square handkerchief, nine circular designs each of radius 7 cm are made (see Fig. 12.29). Find the area of the remaining portion of the handkerchief.

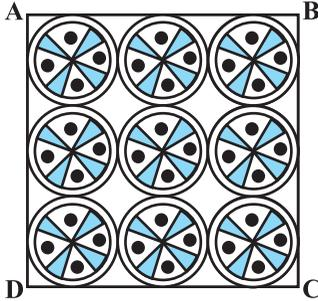


Fig. 12.29

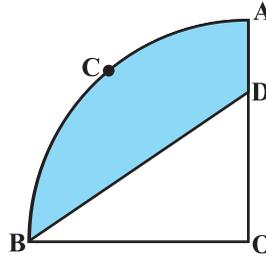


Fig. 12.30

12. In Fig. 12.30, OACB is a quadrant of a circle with centre O and radius 3.5 cm. If  $OD = 2$  cm, find the area of the  
 (i) quadrant OACB, (ii) shaded region.
13. In Fig. 12.31, a square OABC is inscribed in a quadrant OPBQ. If  $OA = 20$  cm, find the area of the shaded region. (Use  $\pi = 3.14$ )

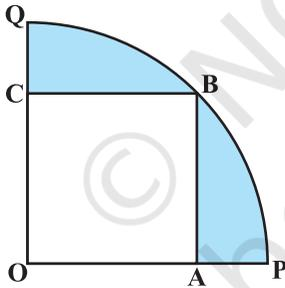


Fig. 12.31

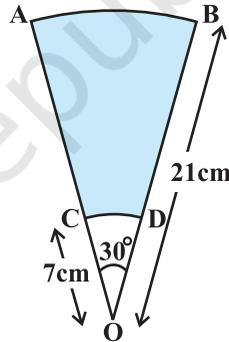


Fig. 12.32

14. AB and CD are respectively arcs of two concentric circles of radii 21 cm and 7 cm and centre O (see Fig. 12.32). If  $\angle AOB = 30^\circ$ , find the area of the shaded region.
15. In Fig. 12.33, ABC is a quadrant of a circle of radius 14 cm and a semicircle is drawn with BC as diameter. Find the area of the shaded region.

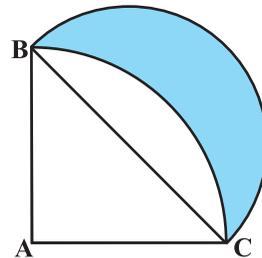


Fig. 12.33

16. Calculate the area of the designed region in Fig. 12.34 common between the two quadrants of circles of radius 8 cm each.

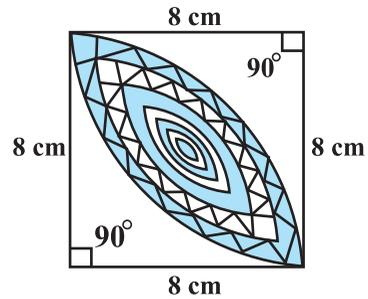


Fig. 12.34

### 12.5 Summary

In this chapter, you have studied the following points :

1. Circumference of a circle =  $2\pi r$ .
2. Area of a circle =  $\pi r^2$ .
3. Length of an arc of a sector of a circle with radius  $r$  and angle with degree measure  $\theta$  is  $\frac{\theta}{360} \times 2\pi r$ .
4. Area of a sector of a circle with radius  $r$  and angle with degree measure  $\theta$  is  $\frac{\theta}{360} \times \pi r^2$ .
5. Area of segment of a circle  
= Area of the corresponding sector – Area of the corresponding triangle.

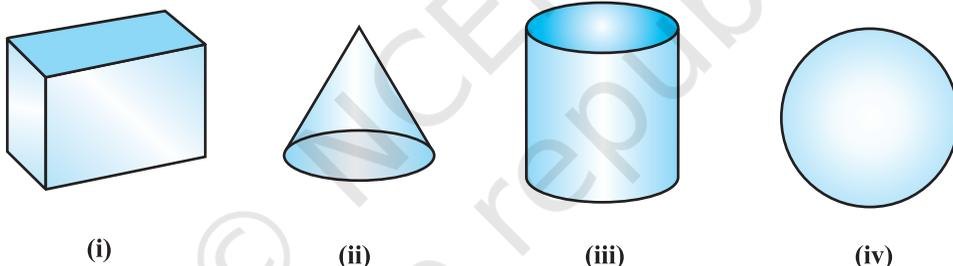


1062CH13

# SURFACE AREAS AND VOLUMES **13**

## 13.1 Introduction

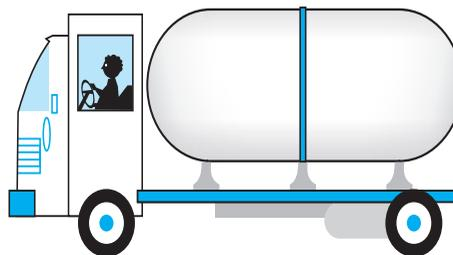
From Class IX, you are familiar with some of the solids like cuboid, cone, cylinder, and sphere (see Fig. 13.1). You have also learnt how to find their surface areas and volumes.



**Fig. 13.1**

In our day-to-day life, we come across a number of solids made up of combinations of two or more of the basic solids as shown above.

You must have seen a truck with a container fitted on its back (see Fig. 13.2), carrying oil or water from one place to another. Is it in the shape of any of the four basic solids mentioned above? You may guess that it is made of a cylinder with two hemispheres as its ends.



**Fig. 13.2**

Again, you may have seen an object like the one in Fig. 13.3. Can you name it? A test tube, right! You would have used one in your science laboratory. This tube is also a combination of a cylinder and a hemisphere. Similarly, while travelling, you may have seen some big and beautiful buildings or monuments made up of a combination of solids mentioned above.

If for some reason you wanted to find the surface areas, or volumes, or capacities of such objects, how would you do it? We cannot classify these under any of the solids you have already studied.

In this chapter, you will see how to find surface areas and volumes of such objects.

### 13.2 Surface Area of a Combination of Solids

Let us consider the container seen in Fig. 13.2. How do we find the surface area of such a solid? Now, whenever we come across a new problem, we first try to see, if we can break it down into smaller problems, we have earlier solved. We can see that this solid is made up of a cylinder with two hemispheres stuck at either end. It would look like what we have in Fig. 13.4, after we put the pieces all together.



Fig. 13.4

If we consider the surface of the newly formed object, we would be able to see only the curved surfaces of the two hemispheres and the curved surface of the cylinder.

So, the *total* surface area of the new solid is the sum of the *curved* surface areas of each of the individual parts. This gives,

$$\begin{aligned} \text{TSA of new solid} &= \text{CSA of one hemisphere} + \text{CSA of cylinder} \\ &\quad + \text{CSA of other hemisphere} \end{aligned}$$

where TSA, CSA stand for 'Total Surface Area' and 'Curved Surface Area' respectively.

Let us now consider another situation. Suppose we are making a toy by putting together a hemisphere and a cone. Let us see the steps that we would be going through.

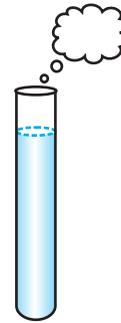


Fig. 13.3

First, we would take a cone and a hemisphere and bring their flat faces together. Here, of course, we would take the base radius of the cone equal to the radius of the hemisphere, for the toy is to have a smooth surface. So, the steps would be as shown in Fig. 13.5.

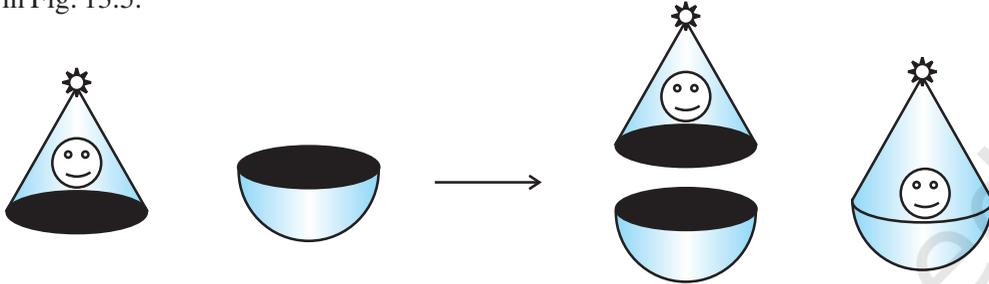


Fig. 13.5

At the end of our trial, we have got ourselves a nice round-bottomed toy. Now if we want to find how much paint we would require to colour the surface of this toy, what would we need to know? We would need to know the surface area of the toy, which consists of the CSA of the hemisphere and the CSA of the cone.

So, we can say:

$$\text{Total surface area of the toy} = \text{CSA of hemisphere} + \text{CSA of cone}$$

Now, let us consider some examples.

**Example 1 :** Rasheed got a playing top (*lattu*) as his birthday present, which surprisingly had no colour on it. He wanted to colour it with his crayons. The top is shaped like a cone surmounted by a hemisphere (see Fig 13.6). The entire top is 5 cm in height and the diameter of the top is 3.5 cm. Find the area he

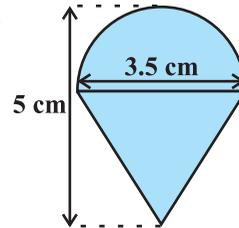


Fig. 13.6

has to colour. (Take  $\pi = \frac{22}{7}$ )

**Solution :** This top is exactly like the object we have discussed in Fig. 13.5. So, we can conveniently use the result we have arrived at there. That is :

$$\text{TSA of the toy} = \text{CSA of hemisphere} + \text{CSA of cone}$$

$$\text{Now, the curved surface area of the hemisphere} = \frac{1}{2}(4\pi r^2) = 2\pi r^2$$

$$= \left( 2 \times \frac{22}{7} \times \frac{3.5}{2} \times \frac{3.5}{2} \right) \text{cm}^2$$

Also, the height of the cone = height of the top – height (radius) of the hemispherical part

$$= \left( 5 - \frac{3.5}{2} \right) \text{ cm} = 3.25 \text{ cm}$$

So, the slant height of the cone ( $l$ ) =  $\sqrt{r^2 + h^2} = \sqrt{\left(\frac{3.5}{2}\right)^2 + (3.25)^2} \text{ cm} = 3.7 \text{ cm}$  (approx.)

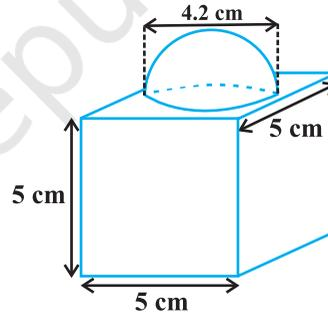
Therefore, CSA of cone =  $\pi r l = \left(\frac{22}{7} \times \frac{3.5}{2} \times 3.7\right) \text{ cm}^2$

This gives the surface area of the top as

$$\begin{aligned} &= \left( 2 \times \frac{22}{7} \times \frac{3.5}{2} \times \frac{3.5}{2} \right) \text{ cm}^2 + \left( \frac{22}{7} \times \frac{3.5}{2} \times 3.7 \right) \text{ cm}^2 \\ &= \frac{22}{7} \times \frac{3.5}{2} (3.5 + 3.7) \text{ cm}^2 = \frac{11}{2} \times (3.5 + 3.7) \text{ cm}^2 = 39.6 \text{ cm}^2 \text{ (approx.)} \end{aligned}$$

You may note that ‘total surface area of the top’ is *not* the sum of the total surface areas of the cone and hemisphere.

**Example 2 :** The decorative block shown in Fig. 13.7 is made of two solids — a cube and a hemisphere. The base of the block is a cube with edge 5 cm, and the hemisphere fixed on the top has a diameter of 4.2 cm. Find the total surface area of the block. (Take  $\pi = \frac{22}{7}$ )



**Fig. 13.7**

**Solution :** The total surface area of the cube =  $6 \times (\text{edge})^2 = 6 \times 5 \times 5 \text{ cm}^2 = 150 \text{ cm}^2$ .

Note that the part of the cube where the hemisphere is attached is not included in the surface area.

So, the surface area of the block = TSA of cube – base area of hemisphere + CSA of hemisphere

$$= 150 - \pi r^2 + 2 \pi r^2 = (150 + \pi r^2) \text{ cm}^2$$

$$= 150 \text{ cm}^2 + \left( \frac{22}{7} \times \frac{4.2}{2} \times \frac{4.2}{2} \right) \text{ cm}^2$$

$$= (150 + 13.86) \text{ cm}^2 = 163.86 \text{ cm}^2$$

**Example 3 :** A wooden toy rocket is in the shape of a cone mounted on a cylinder, as shown in Fig. 13.8. The height of the entire rocket is 26 cm, while the height of the conical part is 6 cm. The base of the conical portion has a diameter of 5 cm, while the base diameter of the cylindrical portion is 3 cm. If the conical portion is to be painted orange and the cylindrical portion yellow, find the area of the rocket painted with each of these colours. (Take  $\pi = 3.14$ )

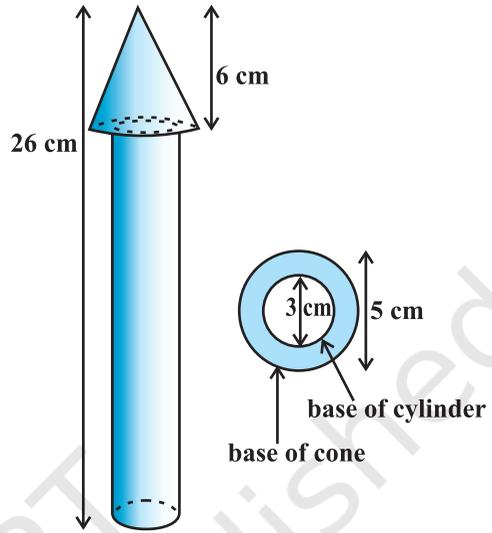
**Solution :** Denote radius of cone by  $r$ , slant height of cone by  $l$ , height of cone by  $h$ , radius of cylinder by  $r'$  and height of cylinder by  $h'$ . Then  $r = 2.5$  cm,  $h = 6$  cm,  $r' = 1.5$  cm,  $h' = 26 - 6 = 20$  cm and

$$l = \sqrt{r^2 + h^2} = \sqrt{2.5^2 + 6^2} \text{ cm} = 6.5 \text{ cm}$$

Here, the conical portion has its circular base resting on the base of the cylinder, but the base of the cone is larger than the base of the cylinder. So, a part of the base of the cone (a ring) is to be painted.

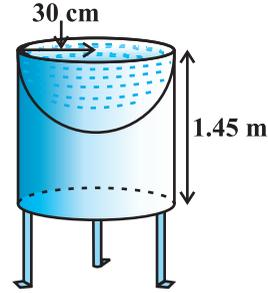
So, the area to be painted orange = CSA of the cone + base area of the cone  
 – base area of the cylinder  
 $= \pi r l + \pi r^2 - \pi (r')^2$   
 $= \pi [(2.5 \times 6.5) + (2.5)^2 - (1.5)^2] \text{ cm}^2$   
 $= \pi [20.25] \text{ cm}^2 = 3.14 \times 20.25 \text{ cm}^2$   
 $= 63.585 \text{ cm}^2$

Now, the area to be painted yellow = CSA of the cylinder  
 + area of one base of the cylinder  
 $= 2\pi r' h' + \pi (r')^2$   
 $= \pi r' (2h' + r')$   
 $= (3.14 \times 1.5) (2 \times 20 + 1.5) \text{ cm}^2$   
 $= 4.71 \times 41.5 \text{ cm}^2$   
 $= 195.465 \text{ cm}^2$



**Fig. 13.8**

**Example 4 :** Mayank made a bird-bath for his garden in the shape of a cylinder with a hemispherical depression at one end (see Fig. 13.9). The height of the cylinder is 1.45 m and its radius is 30 cm. Find the total surface area of the bird-bath. (Take  $\pi = \frac{22}{7}$  )



**Fig. 13.9**

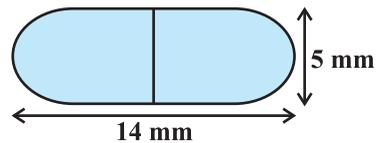
**Solution :** Let  $h$  be height of the cylinder, and  $r$  the common radius of the cylinder and hemisphere. Then,

$$\begin{aligned} \text{the total surface area of the bird-bath} &= \text{CSA of cylinder} + \text{CSA of hemisphere} \\ &= 2\pi rh + 2\pi r^2 = 2\pi r(h + r) \\ &= 2 \times \frac{22}{7} \times 30(1.45 + 0.30) \text{ m}^2 \\ &= 33000 \text{ cm}^2 = 3.3 \text{ m}^2 \end{aligned}$$

### EXERCISE 13.1

Unless stated otherwise, take  $\pi = \frac{22}{7}$ .

- 2 cubes each of volume  $64 \text{ cm}^3$  are joined end to end. Find the surface area of the resulting cuboid.
- A vessel is in the form of a hollow hemisphere mounted by a hollow cylinder. The diameter of the hemisphere is 14 cm and the total height of the vessel is 13 cm. Find the inner surface area of the vessel.
- A toy is in the form of a cone of radius 3.5 cm mounted on a hemisphere of same radius. The total height of the toy is 15.5 cm. Find the total surface area of the toy.
- A cubical block of side 7 cm is surmounted by a hemisphere. What is the greatest diameter the hemisphere can have? Find the surface area of the solid.
- A hemispherical depression is cut out from one face of a cubical wooden block such that the diameter  $l$  of the hemisphere is equal to the edge of the cube. Determine the surface area of the remaining solid.
- A medicine capsule is in the shape of a cylinder with two hemispheres stuck to each of its ends (see Fig. 13.10). The length of the entire capsule is 14 mm and the diameter of the capsule is 5 mm. Find its surface area.



**Fig. 13.10**

7. A tent is in the shape of a cylinder surmounted by a conical top. If the height and diameter of the cylindrical part are 2.1 m and 4 m respectively, and the slant height of the top is 2.8 m, find the area of the canvas used for making the tent. Also, find the cost of the canvas of the tent at the rate of ₹500 per  $\text{m}^2$ . (Note that the base of the tent will not be covered with canvas.)
8. From a solid cylinder whose height is 2.4 cm and diameter 1.4 cm, a conical cavity of the same height and same diameter is hollowed out. Find the total surface area of the remaining solid to the nearest  $\text{cm}^2$ .
9. A wooden article was made by scooping out a hemisphere from each end of a solid cylinder, as shown in Fig. 13.11. If the height of the cylinder is 10 cm, and its base is of radius 3.5 cm, find the total surface area of the article.

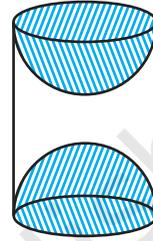


Fig. 13.11

### 13.3 Volume of a Combination of Solids

In the previous section, we have discussed how to find the surface area of solids made up of a combination of two basic solids. Here, we shall see how to calculate their volumes. It may be noted that in calculating the surface area, we have not added the surface areas of the two constituents, because some part of the surface area disappeared in the process of joining them. However, this will not be the case when we calculate the volume. The volume of the solid formed by joining two basic solids will actually be the sum of the volumes of the constituents, as we see in the examples below.

**Example 5 :** Shanta runs an industry in a shed which is in the shape of a cuboid surmounted by a half cylinder (see Fig. 13.12). If the base of the shed is of dimension  $7\text{ m} \times 15\text{ m}$ , and the height of the cuboidal portion is  $8\text{ m}$ , find the volume of air that the shed can hold. Further, suppose the machinery in the shed occupies a total space of  $300\text{ m}^3$ , and there are 20 workers, each of whom occupy about  $0.08\text{ m}^3$  space on an average. Then, how much air is in the

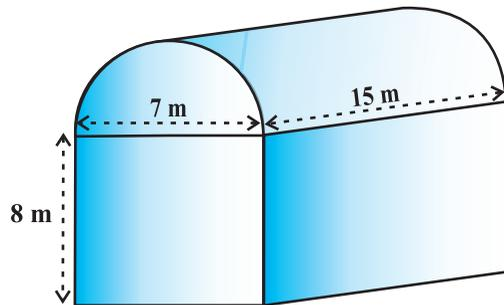


Fig. 13.12

shed? (Take  $\pi = \frac{22}{7}$ )

**Solution :** The volume of air inside the shed (when there are no people or machinery) is given by the volume of air inside the cuboid and inside the half cylinder, taken together.

Now, the length, breadth and height of the cuboid are 15 m, 7 m and 8 m, respectively. Also, the diameter of the half cylinder is 7 m and its height is 15 m.

So, the required volume = volume of the cuboid +  $\frac{1}{2}$  volume of the cylinder

$$= \left[ 15 \times 7 \times 8 + \frac{1}{2} \times \frac{22}{7} \times \frac{7}{2} \times \frac{7}{2} \times 15 \right] \text{m}^3 = 1128.75 \text{m}^3$$

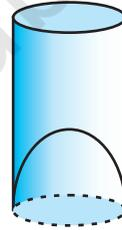
Next, the total space occupied by the machinery =  $300 \text{m}^3$

And the total space occupied by the workers =  $20 \times 0.08 \text{m}^3 = 1.6 \text{m}^3$

Therefore, the volume of the air, when there are machinery and workers

$$= 1128.75 - (300.00 + 1.60) = 827.15 \text{m}^3$$

**Example 6 :** A juice seller was serving his customers using glasses as shown in Fig. 13.13. The inner diameter of the cylindrical glass was 5 cm, but the bottom of the glass had a hemispherical raised portion which reduced the capacity of the glass. If the height of a glass was 10 cm, find the apparent capacity of the glass and its actual capacity. (Use  $\pi = 3.14$ .)



**Fig. 13.13**

**Solution :** Since the inner diameter of the glass = 5 cm and height = 10 cm,

the apparent capacity of the glass =  $\pi r^2 h$

$$= 3.14 \times 2.5 \times 2.5 \times 10 \text{cm}^3 = 196.25 \text{cm}^3$$

But the actual capacity of the glass is less by the volume of the hemisphere at the base of the glass.

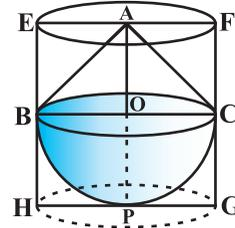
i.e., it is less by  $\frac{2}{3} \pi r^3 = \frac{2}{3} \times 3.14 \times 2.5 \times 2.5 \times 2.5 \text{cm}^3 = 32.71 \text{cm}^3$

So, the actual capacity of the glass = apparent capacity of glass – volume of the hemisphere

$$= (196.25 - 32.71) \text{cm}^3$$

$$= 163.54 \text{cm}^3$$

**Example 7 :** A solid toy is in the form of a hemisphere surmounted by a right circular cone. The height of the cone is 2 cm and the diameter of the base is 4 cm. Determine the volume of the toy. If a right circular cylinder circumscribes the toy, find the difference of the volumes of the cylinder and the toy. (Take  $\pi = 3.14$ )



**Fig. 13.14**

**Solution :** Let BPC be the hemisphere and ABC be the cone standing on the base of the hemisphere (see Fig. 13.14). The radius BO of the hemisphere (as well as of the cone) =  $\frac{1}{2} \times 4 \text{ cm} = 2 \text{ cm}$ .

$$\begin{aligned} \text{So, volume of the toy} &= \frac{2}{3}\pi r^3 + \frac{1}{3}\pi r^2 h \\ &= \left[ \frac{2}{3} \times 3.14 \times (2)^3 + \frac{1}{3} \times 3.14 \times (2)^2 \times 2 \right] \text{ cm}^3 = 25.12 \text{ cm}^3 \end{aligned}$$

Now, let the right circular cylinder EFGH circumscribe the given solid. The radius of the base of the right circular cylinder = HP = BO = 2 cm, and its height is

$$EH = AO + OP = (2 + 2) \text{ cm} = 4 \text{ cm}$$

$$\begin{aligned} \text{So, the volume required} &= \text{volume of the right circular cylinder} - \text{volume of the toy} \\ &= (3.14 \times 2^2 \times 4 - 25.12) \text{ cm}^3 \\ &= 25.12 \text{ cm}^3 \end{aligned}$$

Hence, the required difference of the two volumes =  $25.12 \text{ cm}^3$ .

### EXERCISE 13.2

Unless stated otherwise, take  $\pi = \frac{22}{7}$ .

1. A solid is in the shape of a cone standing on a hemisphere with both their radii being equal to 1 cm and the height of the cone is equal to its radius. Find the volume of the solid in terms of  $\pi$ .
2. Rachel, an engineering student, was asked to make a model shaped like a cylinder with two cones attached at its two ends by using a thin aluminium sheet. The diameter of the model is 3 cm and its length is 12 cm. If each cone has a height of 2 cm, find the volume of air contained in the model that Rachel made. (Assume the outer and inner dimensions of the model to be nearly the same.)

3. A *gulab jamun*, contains sugar syrup up to about 30% of its volume. Find approximately how much syrup would be found in 45 *gulab jamuns*, each shaped like a cylinder with two hemispherical ends with length 5 cm and diameter 2.8 cm (see Fig. 13.15).

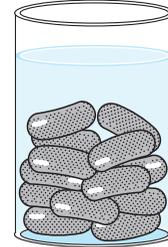


Fig. 13.15

4. A pen stand made of wood is in the shape of a cuboid with four conical depressions to hold pens. The dimensions of the cuboid are 15 cm by 10 cm by 3.5 cm. The radius of each of the depressions is 0.5 cm and the depth is 1.4 cm. Find the volume of wood in the entire stand (see Fig. 13.16).

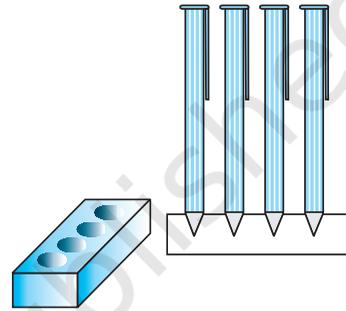


Fig. 13.16

5. A vessel is in the form of an inverted cone. Its height is 8 cm and the radius of its top, which is open, is 5 cm. It is filled with water up to the brim. When lead shots, each of which is a sphere of radius 0.5 cm are dropped into the vessel, one-fourth of the water flows out. Find the number of lead shots dropped in the vessel.
6. A solid iron pole consists of a cylinder of height 220 cm and base diameter 24 cm, which is surmounted by another cylinder of height 60 cm and radius 8 cm. Find the mass of the pole, given that  $1 \text{ cm}^3$  of iron has approximately 8g mass. (Use  $\pi = 3.14$ )
7. A solid consisting of a right circular cone of height 120 cm and radius 60 cm standing on a hemisphere of radius 60 cm is placed upright in a right circular cylinder full of water such that it touches the bottom. Find the volume of water left in the cylinder, if the radius of the cylinder is 60 cm and its height is 180 cm.
8. A spherical glass vessel has a cylindrical neck 8 cm long, 2 cm in diameter; the diameter of the spherical part is 8.5 cm. By measuring the amount of water it holds, a child finds its volume to be  $345 \text{ cm}^3$ . Check whether she is correct, taking the above as the inside measurements, and  $\pi = 3.14$ .

### 13.4 Conversion of Solid from One Shape to Another

We are sure you would have seen candles. Generally, they are in the shape of a cylinder. You may have also seen some candles shaped like an animal (see Fig. 13.17).

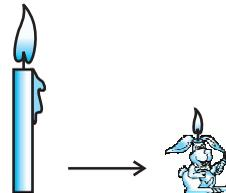


Fig. 13.17

How are they made? If you want a candle of any special shape, you will have to heat the wax in a metal container till it becomes completely liquid. Then you will have to pour it into another container which has the special shape that you want. For example, take a candle in the shape of a solid cylinder, melt it and pour whole of the molten wax into another container shaped like a rabbit. On cooling, you will obtain a candle in the shape of the rabbit. The volume of the new candle will be the same as the volume of the earlier candle. This is what we have to remember when we come across objects which are converted from one shape to another, or when a liquid which originally filled one container of a particular shape is poured into another container of a different shape or size, as you see in Fig 13.18.

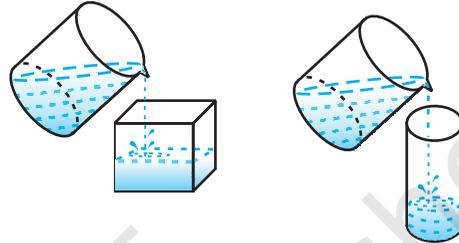


Fig. 13.18

To understand what has been discussed, let us consider some examples.

**Example 8:** A cone of height 24 cm and radius of base 6 cm is made up of modelling clay. A child reshapes it in the form of a sphere. Find the radius of the sphere.

**Solution :** Volume of cone =  $\frac{1}{3} \times \pi \times 6 \times 6 \times 24 \text{ cm}^3$

If  $r$  is the radius of the sphere, then its volume is  $\frac{4}{3} \pi r^3$ .

Since, the volume of clay in the form of the cone and the sphere remains the same, we have

$$\frac{4}{3} \times \pi \times r^3 = \frac{1}{3} \times \pi \times 6 \times 6 \times 24$$

i.e.,

$$r^3 = 3 \times 3 \times 24 = 3^3 \times 2^3$$

So,

$$r = 3 \times 2 = 6$$

Therefore, the radius of the sphere is 6 cm.

**Example 9 :** Selvi's house has an overhead tank in the shape of a cylinder. This is filled by pumping water from a sump (an underground tank) which is in the shape of a cuboid. The sump has dimensions 1.57 m  $\times$  1.44 m  $\times$  95cm. The overhead tank has its radius 60 cm and height 95 cm. Find the height of the water left in the sump after the overhead tank has been completely filled with water from the sump which had been full. Compare the capacity of the tank with that of the sump. (Use  $\pi = 3.14$ )

**Solution :** The volume of water in the overhead tank equals the volume of the water removed from the sump.

$$\begin{aligned}\text{Now, the volume of water in the overhead tank (cylinder)} &= \pi r^2 h \\ &= 3.14 \times 0.6 \times 0.6 \times 0.95 \text{ m}^3\end{aligned}$$

$$\text{The volume of water in the sump when full} = l \times b \times h = 1.57 \times 1.44 \times 0.95 \text{ m}^3$$

The volume of water left in the sump after filling the tank

$$= [(1.57 \times 1.44 \times 0.95) - (3.14 \times 0.6 \times 0.6 \times 0.95)] \text{ m}^3 = (1.57 \times 0.6 \times 0.6 \times 0.95 \times 2) \text{ m}^3$$

$$\begin{aligned}\text{So, the height of the water left in the sump} &= \frac{\text{volume of water left in the sump}}{l \times b} \\ &= \frac{1.57 \times 0.6 \times 0.6 \times 0.95 \times 2}{1.57 \times 1.44} \text{ m} \\ &= 0.475 \text{ m} = 47.5 \text{ cm}\end{aligned}$$

$$\text{Also, } \frac{\text{Capacity of tank}}{\text{Capacity of sump}} = \frac{3.14 \times 0.6 \times 0.6 \times 0.95}{1.57 \times 1.44 \times 0.95} = \frac{1}{2}$$

Therefore, the capacity of the tank is half the capacity of the sump.

**Example 10 :** A copper rod of diameter 1 cm and length 8 cm is drawn into a wire of length 18 m of uniform thickness. Find the thickness of the wire.

$$\text{Solution : The volume of the rod} = \pi \times \left(\frac{1}{2}\right)^2 \times 8 \text{ cm}^3 = 2\pi \text{ cm}^3.$$

$$\text{The length of the new wire of the same volume} = 18 \text{ m} = 1800 \text{ cm}$$

$$\text{If } r \text{ is the radius (in cm) of cross-section of the wire, its volume} = \pi \times r^2 \times 1800 \text{ cm}^3$$

$$\text{Therefore, } \pi \times r^2 \times 1800 = 2\pi$$

$$\text{i.e., } r^2 = \frac{1}{900}$$

$$\text{i.e., } r = \frac{1}{30}$$

So, the diameter of the cross section, i.e., the thickness of the wire is  $\frac{1}{15}$  cm, i.e., 0.67mm (approx.).

**Example 11 :** A hemispherical tank full of water is emptied by a pipe at the rate of  $3\frac{4}{7}$  litres per second. How much time will it take to empty half the tank, if it is 3m in diameter? (Take  $\pi = \frac{22}{7}$ )

**Solution :** Radius of the hemispherical tank =  $\frac{3}{2}$  m

$$\text{Volume of the tank} = \frac{2}{3} \times \frac{22}{7} \times \left(\frac{3}{2}\right)^3 \text{ m}^3 = \frac{99}{14} \text{ m}^3$$

$$\begin{aligned} \text{So, the volume of the water to be emptied} &= \frac{1}{2} \times \frac{99}{14} \text{ m}^3 = \frac{99}{28} \times 1000 \text{ litres} \\ &= \frac{99000}{28} \text{ litres} \end{aligned}$$

Since,  $\frac{25}{7}$  litres of water is emptied in 1 second,  $\frac{99000}{28}$  litres of water will be emptied in  $\frac{99000}{28} \times \frac{7}{25}$  seconds, i.e., in 16.5 minutes.

### EXERCISE 13.3

Take  $\pi = \frac{22}{7}$ , unless stated otherwise.

1. A metallic sphere of radius 4.2 cm is melted and recast into the shape of a cylinder of radius 6 cm. Find the height of the cylinder.
2. Metallic spheres of radii 6 cm, 8 cm and 10 cm, respectively, are melted to form a single solid sphere. Find the radius of the resulting sphere.
3. A 20 m deep well with diameter 7 m is dug and the earth from digging is evenly spread out to form a platform 22 m by 14 m. Find the height of the platform.
4. A well of diameter 3 m is dug 14 m deep. The earth taken out of it has been spread evenly all around it in the shape of a circular ring of width 4 m to form an embankment. Find the height of the embankment.
5. A container shaped like a right circular cylinder having diameter 12 cm and height 15 cm is full of ice cream. The ice cream is to be filled into cones of height 12 cm and diameter 6 cm, having a hemispherical shape on the top. Find the number of such cones which can be filled with ice cream.
6. How many silver coins, 1.75 cm in diameter and of thickness 2 mm, must be melted to form a cuboid of dimensions 5.5 cm  $\times$  10 cm  $\times$  3.5 cm?

7. A cylindrical bucket, 32 cm high and with radius of base 18 cm, is filled with sand. This bucket is emptied on the ground and a conical heap of sand is formed. If the height of the conical heap is 24 cm, find the radius and slant height of the heap.
8. Water in a canal, 6 m wide and 1.5 m deep, is flowing with a speed of 10 km/h. How much area will it irrigate in 30 minutes, if 8 cm of standing water is needed?
9. A farmer connects a pipe of internal diameter 20 cm from a canal into a cylindrical tank in her field, which is 10 m in diameter and 2 m deep. If water flows through the pipe at the rate of 3 km/h, in how much time will the tank be filled?

### 13.5 Frustum of a Cone

In Section 13.2, we observed objects that are formed when two basic solids were joined together. Let us now do something different. We will take a right circular cone and *remove* a portion of it. There are so many ways in which we can do this. But one particular case that we are interested in is the removal of a smaller right circular cone by cutting the given cone by a plane parallel to its base. You must have observed that the glasses (tumblers), in general, used for drinking water, are of this shape. (See Fig. 13.19)

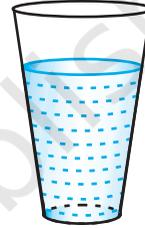


Fig. 13.19

**Activity 1 :** Take some clay, or any other such material (like plasticine, etc.) and form a cone. Cut it with a knife parallel to its base. Remove the smaller cone. What are you left with? You are left with a solid called a *frustum* of the cone. You can see that this has two circular ends with different radii.

So, given a cone, when we slice (or cut) through it with a plane parallel to its base (see Fig. 13.20) and remove the cone that is formed on one side of that plane, the part that is now left over on the other side of the plane is called a **frustum\* of the cone**.

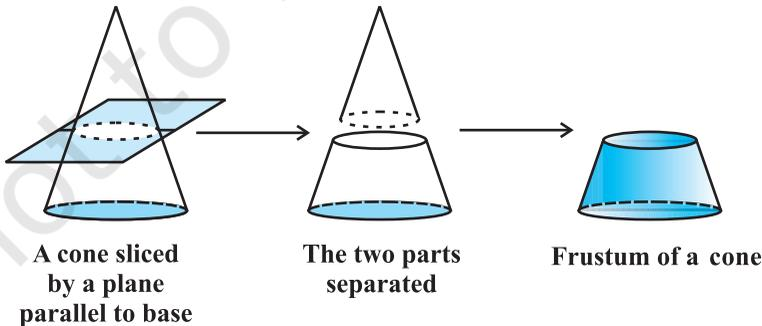


Fig. 13.20

\*'Frustum' is a latin word meaning 'piece cut off', and its plural is 'frusta'.

How can we find the surface area and volume of a frustum of a cone? Let us explain it through an example.

**Example 12 :** The radii of the ends of a frustum of a cone 45 cm high are 28 cm and 7 cm (see Fig. 13.21). Find its volume, the curved surface area and the total surface area

(Take  $\pi = \frac{22}{7}$ ).

**Solution :** The frustum can be viewed as a difference of two right circular cones OAB and OCD (see Fig. 13.21). Let the height (in cm) of the cone OAB be  $h_1$  and its slant height  $l_1$ , i.e.,  $OP = h_1$  and  $OA = OB = l_1$ . Let  $h_2$  be the height of cone OCD and  $l_2$  its slant height.

We have :  $r_1 = 28$  cm,  $r_2 = 7$  cm

and the height of frustum ( $h$ ) = 45 cm. Also,

$$h_1 = 45 + h_2 \quad (1)$$

We first need to determine the respective heights  $h_1$  and  $h_2$  of the cone OAB and OCD.

Since the triangles OPB and OQD are similar (Why?), we have

$$\frac{h_1}{h_2} = \frac{28}{7} = \frac{4}{1} \quad (2)$$

From (1) and (2), we get  $h_2 = 15$  and  $h_1 = 60$ .

Now, the volume of the frustum

= volume of the cone OAB – volume of the cone OCD

$$= \left[ \frac{1}{3} \cdot \frac{22}{7} \cdot (28)^2 \cdot (60) - \frac{1}{3} \cdot \frac{22}{7} \cdot (7)^2 \cdot (15) \right] \text{cm}^3 = 48510 \text{ cm}^3$$

The respective slant height  $l_2$  and  $l_1$  of the cones OCD and OAB are given by

$$l_2 = \sqrt{(7)^2 + (15)^2} = 16.55 \text{ cm (approx.)}$$

$$l_1 = \sqrt{(28)^2 + (60)^2} = 4\sqrt{(7)^2 + (15)^2} = 4 \times 16.55 = 66.20 \text{ cm}$$

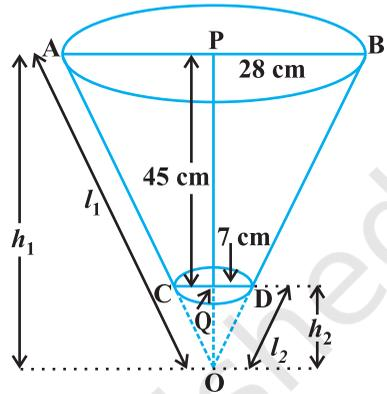


Fig. 13.21

$$\begin{aligned}\text{Thus, the curved surface area of the frustum} &= \pi r_1 l_1 - \pi r_2 l_2 \\ &= \frac{22}{7} (28)(66.20) - \frac{22}{7} (7)(16.55) = 5461.5 \text{ cm}^2\end{aligned}$$

Now, the total surface area of the frustum

$$\begin{aligned}&= \text{the curved surface area} + \pi r_1^2 + \pi r_2^2 \\ &= 5461.5 \text{ cm}^2 + \frac{22}{7} (28)^2 \text{ cm}^2 + \frac{22}{7} (7)^2 \text{ cm}^2 \\ &= 5461.5 \text{ cm}^2 + 2464 \text{ cm}^2 + 154 \text{ cm}^2 = 8079.5 \text{ cm}^2.\end{aligned}$$

Let  $h$  be the height,  $l$  the slant height and  $r_1$  and  $r_2$  the radii of the ends ( $r_1 > r_2$ ) of the frustum of a cone. Then we can directly find the volume, the curved surface area and the total surface area of frustum by using the formulae given below :

- (i) *Volume of the frustum of the cone*  $= \frac{1}{3} \pi h (r_1^2 + r_2^2 + r_1 r_2)$ .
- (ii) *the curved surface area of the frustum of the cone*  $= \pi (r_1 + r_2) l$   
where  $l = \sqrt{h^2 + (r_1 - r_2)^2}$ .
- (iii) *Total surface area of the frustum of the cone*  $= \pi l (r_1 + r_2) + \pi r_1^2 + \pi r_2^2$ ,  
where  $l = \sqrt{h^2 + (r_1 - r_2)^2}$ .

These formulae can be derived using the idea of similarity of triangles but we shall not be doing derivations here.

Let us solve Example 12, using these formulae :

$$\begin{aligned}\text{(i) Volume of the frustum} &= \frac{1}{3} \pi h (r_1^2 + r_2^2 + r_1 r_2) \\ &= \frac{1}{3} \cdot \frac{22}{7} \cdot 45 \cdot [(28)^2 + (7)^2 + (28)(7)] \text{ cm}^3 \\ &= 48510 \text{ cm}^3\end{aligned}$$

$$\begin{aligned}\text{(ii) We have} \quad l &= \sqrt{h^2 + (r_1 - r_2)^2} = \sqrt{(45)^2 + (28 - 7)^2} \text{ cm} \\ &= 3\sqrt{(15)^2 + (7)^2} = 49.65 \text{ cm}\end{aligned}$$

So, the curved surface area of the frustum

$$= \pi(r_1 + r_2)l = \frac{22}{7}(28 + 7)(49.65) = 5461.5 \text{ cm}^2$$

(iii) Total surface area of the frustum

$$\begin{aligned} &= \pi(r_1 + r_2)l + \pi r_1^2 + \pi r_2^2 \\ &= \left[ 5461.5 + \frac{22}{7}(28)^2 + \frac{22}{7}(7)^2 \right] \text{ cm}^2 = 8079.5 \text{ cm}^2 \end{aligned}$$

Let us apply these formulae in some examples.

**Example 13 :** Hanumappa and his wife Gangamma are busy making jaggery out of sugarcane juice. They have processed the sugarcane juice to make the molasses, which is poured into moulds in the shape of a frustum of a cone having the diameters of its two circular faces as 30 cm and 35 cm and the vertical height of the mould is 14 cm (see Fig. 13.22). If each  $\text{cm}^3$  of molasses has mass about 1.2 g, find the mass of the molasses that can

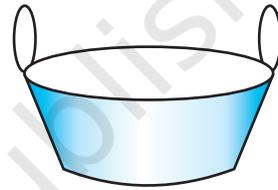


Fig. 13.22

be poured into each mould. (Take  $\pi = \frac{22}{7}$ )

**Solution :** Since the mould is in the shape of a frustum of a cone, the quantity (volume)

of molasses that can be poured into it =  $\frac{\pi}{3}h(r_1^2 + r_2^2 + r_1 r_2)$ ,

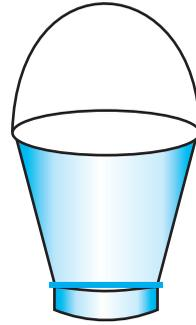
where  $r_1$  is the radius of the larger base and  $r_2$  is the radius of the smaller base.

$$= \frac{1}{3} \times \frac{22}{7} \times 14 \left[ \left( \frac{35}{2} \right)^2 + \left( \frac{30}{2} \right)^2 + \left( \frac{35}{2} \times \frac{30}{2} \right) \right] \text{ cm}^3 = 11641.7 \text{ cm}^3.$$

It is given that  $1 \text{ cm}^3$  of molasses has mass 1.2g. So, the mass of the molasses that can be poured into each mould =  $(11641.7 \times 1.2)$  g

$$= 13970.04 \text{ g} = 13.97 \text{ kg} = 14 \text{ kg (approx.)}$$

**Example 14 :** An open metal bucket is in the shape of a frustum of a cone, mounted on a hollow cylindrical base made of the same metallic sheet (see Fig. 13.23). The diameters of the two circular ends of the bucket are 45 cm and 25 cm, the total vertical height of the bucket is 40 cm and that of the cylindrical base is 6 cm. Find the area of the metallic sheet used to make the bucket, where we do not take into account the handle of the bucket. Also, find the volume of water the bucket can hold.



**Fig. 13.23**

$$\text{Take } \pi = \frac{22}{7} .$$

**Solution :** The total height of the bucket = 40 cm, which includes the height of the base. So, the height of the frustum of the cone =  $(40 - 6)$  cm = 34 cm.

Therefore, the slant height of the frustum,  $l = \sqrt{h^2 + (r_1 - r_2)^2}$ ,

where  $r_1 = 22.5$  cm,  $r_2 = 12.5$  cm and  $h = 34$  cm.

$$\begin{aligned} \text{So,} \quad l &= \sqrt{34^2 + (22.5 - 12.5)^2} \text{ cm} \\ &= \sqrt{34^2 + 10^2} = 35.44 \text{ cm} \end{aligned}$$

The area of metallic sheet used = curved surface area of frustum of cone

+ area of circular base

+ curved surface area of cylinder

$$\begin{aligned} &= [\pi \times 35.44 (22.5 + 12.5) + \pi \times (12.5)^2 \\ &\quad + 2\pi \times 12.5 \times 6] \text{ cm}^2 \end{aligned}$$

$$= \frac{22}{7} (1240.4 + 156.25 + 150) \text{ cm}^2$$

$$= 4860.9 \text{ cm}^2$$

Now, the volume of water that the bucket can hold (also, known as the capacity of the bucket)

$$\begin{aligned}
 &= \frac{\pi \times h}{3} \times (r_1^2 + r_2^2 + r_1 r_2) \\
 &= \frac{22}{7} \times \frac{34}{3} \times [(22.5)^2 + (12.5)^2 + 22.5 \times 12.5] \text{ cm}^3 \\
 &= \frac{22}{7} \times \frac{34}{3} \times 943.75 = 33615.48 \text{ cm}^3 \\
 &= 33.62 \text{ litres (approx.)}
 \end{aligned}$$

### EXERCISE 13.4

Use  $\pi = \frac{22}{7}$  unless stated otherwise.

1. A drinking glass is in the shape of a frustum of a cone of height 14 cm. The diameters of its two circular ends are 4 cm and 2 cm. Find the capacity of the glass.
2. The slant height of a frustum of a cone is 4 cm and the perimeters (circumference) of its circular ends are 18 cm and 6 cm. Find the curved surface area of the frustum.
3. A *fez*, the cap used by the Turks, is shaped like the frustum of a cone (see Fig. 13.24). If its radius on the open side is 10 cm, radius at the upper base is 4 cm and its slant height is 15 cm, find the area of material used for making it.
4. A container, opened from the top and made up of a metal sheet, is in the form of a frustum of a cone of height 16 cm with radii of its lower and upper ends as 8 cm and 20 cm, respectively. Find the cost of the milk which can completely fill the container, at the rate of ₹ 20 per litre. Also find the cost of metal sheet used to make the container, if it costs ₹ 8 per 100 cm<sup>2</sup>. (Take  $\pi = 3.14$ )
5. A metallic right circular cone 20 cm high and whose vertical angle is 60° is cut into two parts at the middle of its height by a plane parallel to its base. If the frustum so obtained be drawn into a wire of diameter  $\frac{1}{16}$  cm, find the length of the wire.



Fig. 13.24

### EXERCISE 13.5 (Optional)\*

1. A copper wire, 3 mm in diameter, is wound about a cylinder whose length is 12 cm, and diameter 10 cm, so as to cover the curved surface of the cylinder. Find the length and mass of the wire, assuming the density of copper to be  $8.88 \text{ g per cm}^3$ .
2. A right triangle, whose sides are 3 cm and 4 cm (other than hypotenuse) is made to revolve about its hypotenuse. Find the volume and surface area of the double cone so formed. (Choose value of  $\pi$  as found appropriate.)
3. A cistern, internally measuring  $150 \text{ cm} \times 120 \text{ cm} \times 110 \text{ cm}$ , has  $129600 \text{ cm}^3$  of water in it. Porous bricks are placed in the water until the cistern is full to the brim. Each brick absorbs one-seventeenth of its own volume of water. How many bricks can be put in without overflowing the water, each brick being  $22.5 \text{ cm} \times 7.5 \text{ cm} \times 6.5 \text{ cm}$ ?
4. In one fortnight of a given month, there was a rainfall of 10 cm in a river valley. If the area of the valley is  $7280 \text{ km}^2$ , show that the total rainfall was approximately equivalent to the addition to the normal water of three rivers each 1072 km long, 75 m wide and 3 m deep.
5. An oil funnel made of tin sheet consists of a 10 cm long cylindrical portion attached to a frustum of a cone. If the total height is 22 cm, diameter of the cylindrical portion is 8 cm and the diameter of the top of the funnel is 18 cm, find the area of the tin sheet required to make the funnel (see Fig. 13.25).

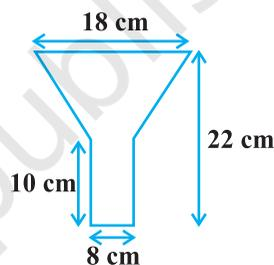


Fig. 13.25

6. Derive the formula for the curved surface area and total surface area of the frustum of a cone, given to you in Section 13.5, using the symbols as explained.
7. Derive the formula for the volume of the frustum of a cone, given to you in Section 13.5, using the symbols as explained.

### 13.6 Summary

In this chapter, you have studied the following points:

1. To determine the surface area of an object formed by combining any two of the basic solids, namely, cuboid, cone, cylinder, sphere and hemisphere.
2. To find the volume of objects formed by combining any two of a cuboid, cone, cylinder, sphere and hemisphere.

\* These exercises are not from the examination point of view.

3. Given a right circular cone, which is sliced through by a plane parallel to its base, when the smaller conical portion is removed, the resulting solid is called a *Frustum of a Right Circular Cone*.
4. The formulae involving the frustum of a cone are:

(i) Volume of a frustum of a cone =  $\frac{1}{3}\pi h(r_1^2 + r_2^2 + r_1r_2)$ .

(ii) Curved surface area of a frustum of a cone =  $\pi l(r_1 + r_2)$  where  $l = \sqrt{h^2 + (r_1 - r_2)^2}$ .

(iii) Total surface area of frustum of a cone =  $\pi l(r_1 + r_2) + \pi(r_1^2 + r_2^2)$  where  
 $h$  = vertical height of the frustum,  $l$  = slant height of the frustum  
 $r_1$  and  $r_2$  are radii of the two bases (ends) of the frustum.



1062CH14

# STATISTICS 14

## 14.1 Introduction

In Class IX, you have studied the classification of given data into ungrouped as well as grouped frequency distributions. You have also learnt to represent the data pictorially in the form of various graphs such as bar graphs, histograms (including those of varying widths) and frequency polygons. In fact, you went a step further by studying certain numerical representatives of the ungrouped data, also called measures of central tendency, namely, *mean*, *median* and *mode*. In this chapter, we shall extend the study of these three measures, i.e., mean, median and mode from ungrouped data to that of *grouped data*. We shall also discuss the concept of cumulative frequency, the cumulative frequency distribution and how to draw cumulative frequency curves, called *ogives*.

## 14.2 Mean of Grouped Data

The mean (or average) of observations, as we know, is the sum of the values of all the observations divided by the total number of observations. From Class IX, recall that if  $x_1, x_2, \dots, x_n$  are observations with respective frequencies  $f_1, f_2, \dots, f_n$ , then this means observation  $x_1$  occurs  $f_1$  times,  $x_2$  occurs  $f_2$  times, and so on.

Now, the sum of the values of all the observations =  $f_1x_1 + f_2x_2 + \dots + f_nx_n$ , and the number of observations =  $f_1 + f_2 + \dots + f_n$ .

So, the mean  $\bar{x}$  of the data is given by

$$\bar{x} = \frac{f_1x_1 + f_2x_2 + \dots + f_nx_n}{f_1 + f_2 + \dots + f_n}$$

Recall that we can write this in short form by using the Greek letter  $\Sigma$  (capital sigma) which means summation. That is,

$$\bar{x} = \frac{\sum_{i=1}^n f_i x_i}{\sum_{i=1}^n f_i}$$

which, more briefly, is written as  $\bar{x} = \frac{\Sigma f_i x_i}{\Sigma f_i}$ , if it is understood that  $i$  varies from 1 to  $n$ .

Let us apply this formula to find the mean in the following example.

**Example 1 :** The marks obtained by 30 students of Class X of a certain school in a Mathematics paper consisting of 100 marks are presented in table below. Find the mean of the marks obtained by the students.

<b>Marks obtained (<math>x_i</math>)</b>	10	20	36	40	50	56	60	70	72	80	88	92	95
<b>Number of students (<math>f_i</math>)</b>	1	1	3	4	3	2	4	4	1	1	2	3	1

**Solution:** Recall that to find the mean marks, we require the product of each  $x_i$  with the corresponding frequency  $f_i$ . So, let us put them in a column as shown in Table 14.1.

**Table 14.1**

<b>Marks obtained (<math>x_i</math>)</b>	<b>Number of students (<math>f_i</math>)</b>	<b><math>f_i x_i</math></b>
10	1	10
20	1	20
36	3	108
40	4	160
50	3	150
56	2	112
60	4	240
70	4	280
72	1	72
80	1	80
88	2	176
92	3	276
95	1	95
<b>Total</b>	$\Sigma f_i = 30$	$\Sigma f_i x_i = 1779$

Now,

$$\bar{x} = \frac{\sum f_i x_i}{\sum f_i} = \frac{1779}{30} = 59.3$$

Therefore, the mean marks obtained is 59.3.

In most of our real life situations, data is usually so large that to make a meaningful study it needs to be condensed as grouped data. So, we need to convert given ungrouped data into grouped data and devise some method to find its mean.

Let us convert the ungrouped data of Example 1 into grouped data by forming class-intervals of width, say 15. Remember that, while allocating frequencies to each class-interval, students falling in any upper class-limit would be considered in the next class, e.g., 4 students who have obtained 40 marks would be considered in the class-interval 40-55 and not in 25-40. With this convention in our mind, let us form a grouped frequency distribution table (see Table 14.2).

**Table 14.2**

<b>Class interval</b>	10 - 25	25 - 40	40 - 55	55 - 70	70 - 85	85 - 100
<b>Number of students</b>	2	3	7	6	6	6

Now, for each class-interval, we require a point which would serve as the representative of the whole class. *It is assumed that the frequency of each class-interval is centred around its mid-point.* So the *mid-point* (or *class mark*) of each class can be chosen to represent the observations falling in the class. Recall that we find the mid-point of a class (or its class mark) by finding the average of its upper and lower limits. That is,

$$\text{Class mark} = \frac{\text{Upper class limit} + \text{Lower class limit}}{2}$$

With reference to Table 14.2, for the class 10-25, the class mark is  $\frac{10+25}{2}$ , i.e., 17.5. Similarly, we can find the class marks of the remaining class intervals. We put them in Table 14.3. These class marks serve as our  $x_i$ 's. Now, in general, for the  $i$ th class interval, we have the frequency  $f_i$  corresponding to the class mark  $x_i$ . We can now proceed to compute the mean in the same manner as in Example 1.

Table 14.3

Class interval	Number of students ( $f_i$ )	Class mark ( $x_i$ )	$f_i x_i$
10 - 25	2	17.5	35.0
25 - 40	3	32.5	97.5
40 - 55	7	47.5	332.5
55 - 70	6	62.5	375.0
70 - 85	6	77.5	465.0
85 - 100	6	92.5	555.0
<b>Total</b>	$\Sigma f_i = 30$		$\Sigma f_i x_i = 1860.0$

The sum of the values in the last column gives us  $\Sigma f_i x_i$ . So, the mean  $\bar{x}$  of the given data is given by

$$\bar{x} = \frac{\Sigma f_i x_i}{\Sigma f_i} = \frac{1860.0}{30} = 62$$

This new method of finding the mean is known as the **Direct Method**.

We observe that Tables 14.1 and 14.3 are using the same data and employing the same formula for the calculation of the mean but the results obtained are different. Can you think why this is so, and which one is more accurate? The difference in the two values is because of the mid-point assumption in Table 14.3, 59.3 being the exact mean, while 62 an approximate mean.

Sometimes when the numerical values of  $x_i$  and  $f_i$  are large, finding the product of  $x_i$  and  $f_i$  becomes tedious and time consuming. So, for such situations, let us think of a method of reducing these calculations.

We can do nothing with the  $f_i$ 's, but we can change each  $x_i$  to a smaller number so that our calculations become easy. How do we do this? What about subtracting a fixed number from each of these  $x_i$ 's? Let us try this method.

The first step is to choose one among the  $x_i$ 's as the *assumed mean*, and denote it by ' $a$ '. Also, to further reduce our calculation work, we may take ' $a$ ' to be that  $x_i$  which lies in the centre of  $x_1, x_2, \dots, x_n$ . So, we can choose  $a = 47.5$  or  $a = 62.5$ . Let us choose  $a = 47.5$ .

The next step is to find the difference  $d_i$  between  $a$  and each of the  $x_i$ 's, that is, the **deviation** of ' $a$ ' from each of the  $x_i$ 's.

i.e., 
$$d_i = x_i - a = x_i - 47.5$$

The third step is to find the product of  $d_i$  with the corresponding  $f_i$ , and take the sum of all the  $f_i d_i$ 's. The calculations are shown in Table 14.4.

**Table 14.4**

Class interval	Number of students ( $f_i$ )	Class mark ( $x_i$ )	$d_i = x_i - 47.5$	$f_i d_i$
10 - 25	2	17.5	-30	-60
25 - 40	3	32.5	-15	-45
40 - 55	7	47.5	0	0
55 - 70	6	62.5	15	90
70 - 85	6	77.5	30	180
85 - 100	6	92.5	45	270
<b>Total</b>	$\Sigma f_i = 30$			$\Sigma f_i d_i = 435$

So, from Table 14.4, the mean of the deviations,  $\bar{d} = \frac{\Sigma f_i d_i}{\Sigma f_i}$ .

Now, let us find the relation between  $\bar{d}$  and  $\bar{x}$ .

Since in obtaining  $d_i$ , we subtracted 'a' from each  $x_i$ , so, in order to get the mean  $\bar{x}$ , we need to add 'a' to  $\bar{d}$ . This can be explained mathematically as:

$$\text{Mean of deviations, } \bar{d} = \frac{\Sigma f_i d_i}{\Sigma f_i}$$

$$\begin{aligned} \text{So, } \bar{d} &= \frac{\Sigma f_i (x_i - a)}{\Sigma f_i} \\ &= \frac{\Sigma f_i x_i}{\Sigma f_i} - \frac{\Sigma f_i a}{\Sigma f_i} \\ &= \bar{x} - a \frac{\Sigma f_i}{\Sigma f_i} \\ &= \bar{x} - a \end{aligned}$$

$$\text{So, } \bar{x} = a + \bar{d}$$

$$\text{i.e., } \bar{x} = a + \frac{\Sigma f_i d_i}{\Sigma f_i}$$

Substituting the values of  $a$ ,  $\Sigma f_i d_i$  and  $\Sigma f_i$  from Table 14.4, we get

$$\bar{x} = 47.5 + \frac{435}{30} = 47.5 + 14.5 = 62.$$

Therefore, the mean of the marks obtained by the students is 62.

The method discussed above is called the **Assumed Mean Method**.

**Activity 1 :** From the Table 14.3 find the mean by taking each of  $x_i$  (i.e., 17.5, 32.5, and so on) as 'a'. What do you observe? You will find that the mean determined in each case is the same, i.e., 62. (Why ?)

So, we can say that the value of the mean obtained does not depend on the choice of 'a'.

Observe that in Table 14.4, the values in Column 4 are all multiples of 15. So, if we divide the values in the entire Column 4 by 15, we would get smaller numbers to multiply with  $f_i$ . (Here, 15 is the class size of each class interval.)

So, let  $u_i = \frac{x_i - a}{h}$ , where  $a$  is the assumed mean and  $h$  is the class size.

Now, we calculate  $u_i$  in this way and continue as before (i.e., find  $f_i u_i$  and then  $\Sigma f_i u_i$ ). Taking  $h = 15$ , let us form Table 14.5.

**Table 14.5**

Class interval	$f_i$	$x_i$	$d_i = x_i - a$	$u_i = \frac{x_i - a}{h}$	$f_i u_i$
10 - 25	2	17.5	-30	-2	-4
25 - 40	3	32.5	-15	-1	-3
40 - 55	7	47.5	0	0	0
55 - 70	6	62.5	15	1	6
70 - 85	6	77.5	30	2	12
85 - 100	6	92.5	45	3	18
<b>Total</b>	$\Sigma f_i = 30$				$\Sigma f_i u_i = 29$

Let

$$\bar{u} = \frac{\Sigma f_i u_i}{\Sigma f_i}$$

Here, again let us find the relation between  $\bar{u}$  and  $\bar{x}$ .

We have,

$$u_i = \frac{x_i - a}{h}$$

Therefore,

$$\begin{aligned}\bar{u} &= \frac{\sum f_i \frac{(x_i - a)}{h}}{\sum f_i} = \frac{1}{h} \left[ \frac{\sum f_i x_i - a \sum f_i}{\sum f_i} \right] \\ &= \frac{1}{h} \left[ \frac{\sum f_i x_i}{\sum f_i} - a \frac{\sum f_i}{\sum f_i} \right] \\ &= \frac{1}{h} [\bar{x} - a]\end{aligned}$$

So,

$$h\bar{u} = \bar{x} - a$$

i.e.,

$$\bar{x} = a + h\bar{u}$$

So,

$$\bar{x} = a + h \left( \frac{\sum f_i u_i}{\sum f_i} \right)$$

Now, substituting the values of  $a$ ,  $h$ ,  $\sum f_i u_i$  and  $\sum f_i$  from Table 14.5, we get

$$\begin{aligned}\bar{x} &= 47.5 + 15 \times \left( \frac{29}{30} \right) \\ &= 47.5 + 14.5 = 62\end{aligned}$$

So, the mean marks obtained by a student is 62.

The method discussed above is called the **Step-deviation** method.

We note that :

- the step-deviation method will be convenient to apply if all the  $d_i$ 's have a common factor.
- The mean obtained by all the three methods is the same.
- The assumed mean method and step-deviation method are just simplified forms of the direct method.
- The formula  $\bar{x} = a + h\bar{u}$  still holds if  $a$  and  $h$  are not as given above, but are

any non-zero numbers such that  $u_i = \frac{x_i - a}{h}$ .

Let us apply these methods in another example.

**Example 2 :** The table below gives the percentage distribution of female teachers in the primary schools of rural areas of various states and union territories (U.T.) of India. Find the mean percentage of female teachers by all the three methods discussed in this section.

Percentage of female teachers	15 - 25	25 - 35	35 - 45	45 - 55	55 - 65	65 - 75	75 - 85
Number of States/U.T.	6	11	7	4	4	2	1

**Source :** *Seventh All India School Education Survey conducted by NCERT*

**Solution :** Let us find the class marks,  $x_i$ , of each class, and put them in a column (see Table 14.6):

**Table 14.6**

Percentage of female teachers	Number of States /U.T. ( $f_i$ )	$x_i$
15 - 25	6	20
25 - 35	11	30
35 - 45	7	40
45 - 55	4	50
55 - 65	4	60
65 - 75	2	70
75 - 85	1	80

Here we take  $a = 50$ ,  $h = 10$ , then  $d_i = x_i - 50$  and  $u_i = \frac{x_i - 50}{10}$ .

We now find  $d_i$  and  $u_i$  and put them in Table 14.7.

Table 14.7

Percentage of female teachers	Number of states/U.T. ( $f_i$ )	$x_i$	$d_i = x_i - 50$	$u_i = \frac{x_i - 50}{10}$	$f_i x_i$	$f_i d_i$	$f_i u_i$
15 - 25	6	20	-30	-3	120	-180	-18
25 - 35	11	30	-20	-2	330	-220	-22
35 - 45	7	40	-10	-1	280	-70	-7
45 - 55	4	50	0	0	200	0	0
55 - 65	4	60	10	1	240	40	4
65 - 75	2	70	20	2	140	40	4
75 - 85	1	80	30	3	80	30	3
<b>Total</b>	<b>35</b>				<b>1390</b>	<b>-360</b>	<b>-36</b>

From the table above, we obtain  $\Sigma f_i = 35$ ,  $\Sigma f_i x_i = 1390$ ,

$$\Sigma f_i d_i = -360, \quad \Sigma f_i u_i = -36.$$

Using the direct method,  $\bar{x} = \frac{\Sigma f_i x_i}{\Sigma f_i} = \frac{1390}{35} = 39.71$

Using the assumed mean method,

$$\bar{x} = a + \frac{\Sigma f_i d_i}{\Sigma f_i} = 50 + \frac{(-360)}{35} = 39.71$$

Using the step-deviation method,

$$\bar{x} = a + \left( \frac{\Sigma f_i u_i}{\Sigma f_i} \right) \times h = 50 + \left( \frac{-36}{35} \right) \times 10 = 39.71$$

Therefore, the mean percentage of female teachers in the primary schools of rural areas is 39.71.

**Remark :** The result obtained by all the three methods is the same. So the choice of method to be used depends on the numerical values of  $x_i$  and  $f_i$ . If  $x_i$  and  $f_i$  are sufficiently small, then the direct method is an appropriate choice. If  $x_i$  and  $f_i$  are numerically large numbers, then we can go for the assumed mean method or step-deviation method. If the class sizes are unequal, and  $x_i$  are large numerically, we can still apply the step-deviation method by taking  $h$  to be a suitable divisor of all the  $d_i$ 's.

**Example 3 :** The distribution below shows the number of wickets taken by bowlers in one-day cricket matches. Find the mean number of wickets by choosing a suitable method. What does the mean signify?

<b>Number of wickets</b>	20 - 60	60 - 100	100 - 150	150 - 250	250 - 350	350 - 450
<b>Number of bowlers</b>	7	5	16	12	2	3

**Solution :** Here, the class size varies, and the  $x_i$ 's are large. Let us still apply the step-deviation method with  $a = 200$  and  $h = 20$ . Then, we obtain the data as in Table 14.8.

**Table 14.8**

<b>Number of wickets taken</b>	<b>Number of bowlers (<math>f_i</math>)</b>	$x_i$	$d_i = x_i - 200$	$u_i = \frac{d_i}{20}$	$u_i f_i$
20 - 60	7	40	-160	-8	-56
60 - 100	5	80	-120	-6	-30
100 - 150	16	125	-75	-3.75	-60
150 - 250	12	200	0	0	0
250 - 350	2	300	100	5	10
350 - 450	3	400	200	10	30
<b>Total</b>	<b>45</b>				<b>-106</b>

$$\text{So, } \bar{u} = \frac{-106}{45}. \text{ Therefore, } \bar{x} = 200 + 20\left(\frac{-106}{45}\right) = 200 - 47.11 = 152.89.$$

This tells us that, on an average, the number of wickets taken by these 45 bowlers in one-day cricket is 152.89.

Now, let us see how well you can apply the concepts discussed in this section!

**Activity 2 :**

Divide the students of your class into three groups and ask each group to do one of the following activities.

1. Collect the marks obtained by all the students of your class in Mathematics in the latest examination conducted by your school. Form a grouped frequency distribution of the data obtained.
2. Collect the daily maximum temperatures recorded for a period of 30 days in your city. Present this data as a grouped frequency table.
3. Measure the heights of all the students of your class (in cm) and form a grouped frequency distribution table of this data.

After all the groups have collected the data and formed grouped frequency distribution tables, the groups should find the mean in each case by the method which they find appropriate.

**EXERCISE 14.1**

1. A survey was conducted by a group of students as a part of their environment awareness programme, in which they collected the following data regarding the number of plants in 20 houses in a locality. Find the mean number of plants per house.

<b>Number of plants</b>	0 - 2	2 - 4	4 - 6	6 - 8	8 - 10	10 - 12	12 - 14
<b>Number of houses</b>	1	2	1	5	6	2	3

Which method did you use for finding the mean, and why?

2. Consider the following distribution of daily wages of 50 workers of a factory.

<b>Daily wages (in ₹)</b>	500 - 520	520 - 540	540 - 560	560 - 580	580 - 600
<b>Number of workers</b>	12	14	8	6	10

Find the mean daily wages of the workers of the factory by using an appropriate method.

3. The following distribution shows the daily pocket allowance of children of a locality. The mean pocket allowance is Rs 18. Find the missing frequency  $f$ .

<b>Daily pocket allowance (in ₹)</b>	11 - 13	13 - 15	15 - 17	17 - 19	19 - 21	21 - 23	23 - 25
<b>Number of children</b>	7	6	9	13	$f$	5	4

4. Thirty women were examined in a hospital by a doctor and the number of heartbeats per minute were recorded and summarised as follows. Find the mean heartbeats per minute for these women, choosing a suitable method.

<b>Number of heartbeats per minute</b>	65 - 68	68 - 71	71 - 74	74 - 77	77 - 80	80 - 83	83 - 86
<b>Number of women</b>	2	4	3	8	7	4	2

5. In a retail market, fruit vendors were selling mangoes kept in packing boxes. These boxes contained varying number of mangoes. The following was the distribution of mangoes according to the number of boxes.

<b>Number of mangoes</b>	50 - 52	53 - 55	56 - 58	59 - 61	62 - 64
<b>Number of boxes</b>	15	110	135	115	25

Find the mean number of mangoes kept in a packing box. Which method of finding the mean did you choose?

6. The table below shows the daily expenditure on food of 25 households in a locality.

<b>Daily expenditure (in ₹)</b>	100 - 150	150 - 200	200 - 250	250 - 300	300 - 350
<b>Number of households</b>	4	5	12	2	2

Find the mean daily expenditure on food by a suitable method.

7. To find out the concentration of  $\text{SO}_2$  in the air (in parts per million, i.e., ppm), the data was collected for 30 localities in a certain city and is presented below:

<b>Concentration of <math>\text{SO}_2</math> (in ppm)</b>	<b>Frequency</b>
0.00 - 0.04	4
0.04 - 0.08	9
0.08 - 0.12	9
0.12 - 0.16	2
0.16 - 0.20	4
0.20 - 0.24	2

Find the mean concentration of  $\text{SO}_2$  in the air.

8. A class teacher has the following absentee record of 40 students of a class for the whole term. Find the mean number of days a student was absent.

<b>Number of days</b>	0 - 6	6 - 10	10 - 14	14 - 20	20 - 28	28 - 38	38 - 40
<b>Number of students</b>	11	10	7	4	4	3	1

9. The following table gives the literacy rate (in percentage) of 35 cities. Find the mean literacy rate.

<b>Literacy rate (in %)</b>	45 - 55	55 - 65	65 - 75	75 - 85	85 - 95
<b>Number of cities</b>	3	10	11	8	3

### 14.3 Mode of Grouped Data

Recall from Class IX, a mode is that value among the observations which occurs most often, that is, the value of the observation having the maximum frequency. Further, we discussed finding the mode of ungrouped data. Here, we shall discuss ways of obtaining a mode of grouped data. It is possible that more than one value may have the same maximum frequency. In such situations, the data is said to be multimodal. Though grouped data can also be multimodal, we shall restrict ourselves to problems having a single mode only.

Let us first recall how we found the mode for ungrouped data through the following example.

**Example 4 :** The wickets taken by a bowler in 10 cricket matches are as follows:

2    6    4    5    0    2    1    3    2    3

Find the mode of the data.

**Solution :** Let us form the frequency distribution table of the given data as follows:

<b>Number of wickets</b>	0	1	2	3	4	5	6
<b>Number of matches</b>	1	1	3	2	1	1	1

Clearly, 2 is the number of wickets taken by the bowler in the maximum number (i.e., 3) of matches. So, the mode of this data is 2.

In a grouped frequency distribution, it is not possible to determine the mode by looking at the frequencies. Here, we can only locate a class with the maximum frequency, called the **modal class**. The mode is a value inside the modal class, and is given by the formula:

$$\text{Mode} = l + \left( \frac{f_1 - f_0}{2f_1 - f_0 - f_2} \right) \times h$$

where  $l$  = lower limit of the modal class,

$h$  = size of the class interval (assuming all class sizes to be equal),

$f_1$  = frequency of the modal class,

$f_0$  = frequency of the class preceding the modal class,

$f_2$  = frequency of the class succeeding the modal class.

Let us consider the following examples to illustrate the use of this formula.

**Example 5 :** A survey conducted on 20 households in a locality by a group of students resulted in the following frequency table for the number of family members in a household:

<b>Family size</b>	1 - 3	3 - 5	5 - 7	7 - 9	9 - 11
<b>Number of families</b>	7	8	2	2	1

Find the mode of this data.

**Solution :** Here the maximum class frequency is 8, and the class corresponding to this frequency is 3 – 5. So, the modal class is 3 – 5.

Now

modal class = 3 – 5, lower limit ( $l$ ) of modal class = 3, class size ( $h$ ) = 2

frequency ( $f_1$ ) of the modal class = 8,

frequency ( $f_0$ ) of class preceding the modal class = 7,

frequency ( $f_2$ ) of class succeeding the modal class = 2.

Now, let us substitute these values in the formula :

$$\begin{aligned}\text{Mode} &= l + \left( \frac{f_1 - f_0}{2f_1 - f_0 - f_2} \right) \times h \\ &= 3 + \left( \frac{8 - 7}{2 \times 8 - 7 - 2} \right) \times 2 = 3 + \frac{2}{7} = 3.286\end{aligned}$$

Therefore, the mode of the data above is 3.286.

**Example 6 :** The marks distribution of 30 students in a mathematics examination are given in Table 14.3 of Example 1. Find the mode of this data. Also compare and interpret the mode and the mean.

**Solution :** Refer to Table 14.3 of Example 1. Since the maximum number of students (i.e., 7) have got marks in the interval 40 - 55, the modal class is 40 - 55. Therefore,

the lower limit ( $l$ ) of the modal class = 40,

the class size ( $h$ ) = 15,

the frequency ( $f_1$ ) of modal class = 7,

the frequency ( $f_0$ ) of the class preceding the modal class = 3,

the frequency ( $f_2$ ) of the class succeeding the modal class = 6.

Now, using the formula:

$$\text{Mode} = l + \left( \frac{f_1 - f_0}{2f_1 - f_0 - f_2} \right) \times h,$$

we get

$$\text{Mode} = 40 + \left( \frac{7 - 3}{14 - 6 - 3} \right) \times 15 = 52$$

So, the mode marks is 52.

Now, from Example 1, you know that the mean marks is 62.

So, the maximum number of students obtained 52 marks, while on an average a student obtained 62 marks.

**Remarks :**

1. In Example 6, the mode is less than the mean. But for some other problems it may be equal or more than the mean also.
2. It depends upon the demand of the situation whether we are interested in finding the average marks obtained by the students or the average of the marks obtained by most

of the students. In the first situation, the mean is required and in the second situation, the mode is required.

**Activity 3 :** Continuing with the same groups as formed in Activity 2 and the situations assigned to the groups. Ask each group to find the mode of the data. They should also compare this with the mean, and interpret the meaning of both.

**Remark :** The mode can also be calculated for grouped data with unequal class sizes. However, we shall not be discussing it.

### EXERCISE 14.2

1. The following table shows the ages of the patients admitted in a hospital during a year:

Age (in years)	5 - 15	15 - 25	25 - 35	35 - 45	45 - 55	55 - 65
Number of patients	6	11	21	23	14	5

Find the mode and the mean of the data given above. Compare and interpret the two measures of central tendency.

2. The following data gives the information on the observed lifetimes (in hours) of 225 electrical components :

Lifetimes (in hours)	0 - 20	20 - 40	40 - 60	60 - 80	80 - 100	100 - 120
Frequency	10	35	52	61	38	29

Determine the modal lifetimes of the components.

3. The following data gives the distribution of total monthly household expenditure of 200 families of a village. Find the modal monthly expenditure of the families. Also, find the mean monthly expenditure :

Expenditure (in ₹)	Number of families
1000 - 1500	24
1500 - 2000	40
2000 - 2500	33
2500 - 3000	28
3000 - 3500	30
3500 - 4000	22
4000 - 4500	16
4500 - 5000	7

4. The following distribution gives the state-wise teacher-student ratio in higher secondary schools of India. Find the mode and mean of this data. Interpret the two measures.

Number of students per teacher	Number of states/U.T.
15 - 20	3
20 - 25	8
25 - 30	9
30 - 35	10
35 - 40	3
40 - 45	0
45 - 50	0
50 - 55	2

5. The given distribution shows the number of runs scored by some top batsmen of the world in one-day international cricket matches.

Runs scored	Number of batsmen
3000 - 4000	4
4000 - 5000	18
5000 - 6000	9
6000 - 7000	7
7000 - 8000	6
8000 - 9000	3
9000 - 10000	1
10000 - 11000	1

Find the mode of the data.

6. A student noted the number of cars passing through a spot on a road for 100 periods each of 3 minutes and summarised it in the table given below. Find the mode of the data :

Number of cars	0 - 10	10 - 20	20 - 30	30 - 40	40 - 50	50 - 60	60 - 70	70 - 80
Frequency	7	14	13	12	20	11	15	8

### 14.4 Median of Grouped Data

As you have studied in Class IX, the median is a measure of central tendency which gives the value of the middle-most observation in the data. Recall that for finding the median of ungrouped data, we first arrange the data values of the observations in

ascending order. Then, if  $n$  is odd, the median is the  $\left(\frac{n+1}{2}\right)$ th observation. And, if  $n$

is even, then the median will be the average of the  $\frac{n}{2}$ th and the  $\left(\frac{n}{2} + 1\right)$ th observations.

Suppose, we have to find the median of the following data, which gives the marks, out of 50, obtained by 100 students in a test :

<b>Marks obtained</b>	20	29	28	33	42	38	43	25
<b>Number of students</b>	6	28	24	15	2	4	1	20

First, we arrange the marks in ascending order and prepare a frequency table as follows :

**Table 14.9**

<b>Marks obtained</b>	<b>Number of students (Frequency)</b>
20	6
25	20
28	24
29	28
33	15
38	4
42	2
43	1
<b>Total</b>	<b>100</b>

Here  $n = 100$ , which is even. The median will be the average of the  $\frac{n}{2}$ th and the  $\left(\frac{n}{2} + 1\right)$ th observations, i.e., the 50th and 51st observations. To find these observations, we proceed as follows:

Table 14.10

Marks obtained	Number of students
20	6
upto 25	$6 + 20 = 26$
upto 28	$26 + 24 = 50$
upto 29	$50 + 28 = 78$
upto 33	$78 + 15 = 93$
upto 38	$93 + 4 = 97$
upto 42	$97 + 2 = 99$
upto 43	$99 + 1 = 100$

Now we add another column depicting this information to the frequency table above and name it as *cumulative frequency column*.

Table 14.11

Marks obtained	Number of students	Cumulative frequency
20	6	6
25	20	26
28	24	50
29	28	78
33	15	93
38	4	97
42	2	99
43	1	100

From the table above, we see that:

50th observation is 28 (Why?)

51st observation is 29

So, 
$$\text{Median} = \frac{28 + 29}{2} = 28.5$$

**Remark :** The part of Table 14.11 consisting Column 1 and Column 3 is known as *Cumulative Frequency Table*. The median marks 28.5 conveys the information that about 50% students obtained marks less than 28.5 and another 50% students obtained marks more than 28.5.

Now, let us see how to obtain the median of grouped data, through the following situation.

Consider a grouped frequency distribution of marks obtained, out of 100, by 53 students, in a certain examination, as follows:

**Table 14.12**

Marks	Number of students
0 - 10	5
10 - 20	3
20 - 30	4
30 - 40	3
40 - 50	3
50 - 60	4
60 - 70	7
70 - 80	9
80 - 90	7
90 - 100	8

From the table above, try to answer the following questions:

How many students have scored marks less than 10? The answer is clearly 5.

How many students have scored less than 20 marks? Observe that the number of students who have scored less than 20 include the number of students who have scored marks from 0 - 10 as well as the number of students who have scored marks from 10 - 20. So, the total number of students with marks less than 20 is  $5 + 3$ , i.e., 8. We say that the cumulative frequency of the class 10-20 is 8.

Similarly, we can compute the cumulative frequencies of the other classes, i.e., the number of students with marks less than 30, less than 40, . . . , less than 100. We give them in Table 14.13 given below:

**Table 14.13**

Marks obtained	Number of students (Cumulative frequency)
Less than 10	5
Less than 20	$5 + 3 = 8$
Less than 30	$8 + 4 = 12$
Less than 40	$12 + 3 = 15$
Less than 50	$15 + 3 = 18$
Less than 60	$18 + 4 = 22$
Less than 70	$22 + 7 = 29$
Less than 80	$29 + 9 = 38$
Less than 90	$38 + 7 = 45$
Less than 100	$45 + 8 = 53$

The distribution given above is called the *cumulative frequency distribution of the less than type*. Here 10, 20, 30, . . . 100, are the upper limits of the respective class intervals.

We can similarly make the table for the number of students with scores, more than or equal to 0, more than or equal to 10, more than or equal to 20, and so on. From Table 14.12, we observe that all 53 students have scored marks more than or equal to 0. Since there are 5 students scoring marks in the interval 0 - 10, this means that there are  $53 - 5 = 48$  students getting more than or equal to 10 marks. Continuing in the same manner, we get the number of students scoring 20 or above as  $48 - 3 = 45$ , 30 or above as  $45 - 4 = 41$ , and so on, as shown in Table 14.14.

Table 14.14

Marks obtained	Number of students (Cumulative frequency)
More than or equal to 0	53
More than or equal to 10	$53 - 5 = 48$
More than or equal to 20	$48 - 3 = 45$
More than or equal to 30	$45 - 4 = 41$
More than or equal to 40	$41 - 3 = 38$
More than or equal to 50	$38 - 3 = 35$
More than or equal to 60	$35 - 4 = 31$
More than or equal to 70	$31 - 7 = 24$
More than or equal to 80	$24 - 9 = 15$
More than or equal to 90	$15 - 7 = 8$

The table above is called a *cumulative frequency distribution of the more than type*. Here 0, 10, 20, . . . , 90 give the lower limits of the respective class intervals.

Now, to find the median of grouped data, we can make use of any of these cumulative frequency distributions.

Let us combine Tables 14.12 and 14.13 to get Table 14.15 given below:

Table 14.15

Marks	Number of students ( $f$ )	Cumulative frequency (cf)
0 - 10	5	5
10 - 20	3	8
20 - 30	4	12
30 - 40	3	15
40 - 50	3	18
50 - 60	4	22
60 - 70	7	29
70 - 80	9	38
80 - 90	7	45
90 - 100	8	53

Now in a grouped data, we may not be able to find the middle observation by looking at the cumulative frequencies as the middle observation will be some value in

a class interval. It is, therefore, necessary to find the value inside a class that divides the whole distribution into two halves. But which class should this be?

To find this class, we find the cumulative frequencies of all the classes and  $\frac{n}{2}$ . We now locate the class whose cumulative frequency is greater than (and nearest to)  $\frac{n}{2}$ . This is called the *median class*. In the distribution above,  $n = 53$ . So,  $\frac{n}{2} = 26.5$ . Now 60 – 70 is the class whose cumulative frequency 29 is greater than (and nearest to)  $\frac{n}{2}$ , i.e., 26.5.

Therefore, 60 – 70 is the **median class**.

After finding the median class, we use the following formula for calculating the median.

$$\text{Median} = l + \left( \frac{\frac{n}{2} - \text{cf}}{f} \right) \times h,$$

where  $l$  = lower limit of median class,  
 $n$  = number of observations,  
 $\text{cf}$  = cumulative frequency of class preceding the median class,  
 $f$  = frequency of median class,  
 $h$  = class size (assuming class size to be equal).

Substituting the values  $\frac{n}{2} = 26.5$ ,  $l = 60$ ,  $\text{cf} = 22$ ,  $f = 7$ ,  $h = 10$  in the formula above, we get

$$\begin{aligned} \text{Median} &= 60 + \left( \frac{26.5 - 22}{7} \right) \times 10 \\ &= 60 + \frac{45}{7} \\ &= 66.4 \end{aligned}$$

So, about half the students have scored marks less than 66.4, and the other half have scored marks more than 66.4.

**Example 7 :** A survey regarding the heights (in cm) of 51 girls of Class X of a school was conducted and the following data was obtained:

Height (in cm)	Number of girls
Less than 140	4
Less than 145	11
Less than 150	29
Less than 155	40
Less than 160	46
Less than 165	51

Find the median height.

**Solution :** To calculate the median height, we need to find the class intervals and their corresponding frequencies.

The given distribution being of the *less than type*, 140, 145, 150, . . . , 165 give the upper limits of the corresponding class intervals. So, the classes should be below 140, 140 - 145, 145 - 150, . . . , 160 - 165. Observe that from the given distribution, we find that there are 4 girls with height less than 140, i.e., the frequency of class interval below 140 is 4. Now, there are 11 girls with heights less than 145 and 4 girls with height less than 140. Therefore, the number of girls with height in the interval 140 - 145 is  $11 - 4 = 7$ . Similarly, the frequency of 145 - 150 is  $29 - 11 = 18$ , for 150 - 155, it is  $40 - 29 = 11$ , and so on. So, our frequency distribution table with the given cumulative frequencies becomes:

**Table 14.16**

Class intervals	Frequency	Cumulative frequency
Below 140	4	4
140 - 145	7	11
145 - 150	18	29
150 - 155	11	40
155 - 160	6	46
160 - 165	5	51

Now  $n = 51$ . So,  $\frac{n}{2} = \frac{51}{2} = 25.5$ . This observation lies in the class 145 - 150. Then,

$$l \text{ (the lower limit)} = 145,$$

$$cf \text{ (the cumulative frequency of the class preceding 145 - 150)} = 11,$$

$$f \text{ (the frequency of the median class 145 - 150)} = 18,$$

$$h \text{ (the class size)} = 5.$$

Using the formula, Median =  $l + \left( \frac{\frac{n}{2} - cf}{f} \right) \times h$ , we have

$$\begin{aligned} \text{Median} &= 145 + \left( \frac{25.5 - 11}{18} \right) \times 5 \\ &= 145 + \frac{72.5}{18} = 149.03. \end{aligned}$$

So, the median height of the girls is 149.03 cm.

This means that the height of about 50% of the girls is less than this height, and 50% are taller than this height.

**Example 8 :** The median of the following data is 525. Find the values of  $x$  and  $y$ , if the total frequency is 100.

Class interval	Frequency
0 - 100	2
100 - 200	5
200 - 300	$x$
300 - 400	12
400 - 500	17
500 - 600	20
600 - 700	$y$
700 - 800	9
800 - 900	7
900 - 1000	4

**Solution :**

Class intervals	Frequency	Cumulative frequency
0 - 100	2	2
100 - 200	5	7
200 - 300	$x$	$7 + x$
300 - 400	12	$19 + x$
400 - 500	17	$36 + x$
500 - 600	20	$56 + x$
600 - 700	$y$	$56 + x + y$
700 - 800	9	$65 + x + y$
800 - 900	7	$72 + x + y$
900 - 1000	4	$76 + x + y$

It is given that  $n = 100$

So,  $76 + x + y = 100$ , i.e.,  $x + y = 24$  (1)

The median is 525, which lies in the class 500 – 600

So,  $l = 500$ ,  $f = 20$ ,  $cf = 36 + x$ ,  $h = 100$

Using the formula : Median =  $l + \left( \frac{\frac{n}{2} - cf}{f} \right) h$ , we get

$$525 = 500 + \left( \frac{50 - 36 - x}{20} \right) \times 100$$

i.e.,  $525 - 500 = (14 - x) \times 5$

i.e.,  $25 = 70 - 5x$

i.e.,  $5x = 70 - 25 = 45$

So,  $x = 9$

Therefore, from (1), we get  $9 + y = 24$

i.e.,  $y = 15$

Now, that you have studied about all the three measures of central tendency, let us discuss **which measure would be best suited for a particular requirement**.

The mean is the most frequently used measure of central tendency because it takes into account all the observations, and lies between the extremes, i.e., the largest and the smallest observations of the entire data. It also enables us to compare two or more distributions. For example, by comparing the average (mean) results of students of different schools of a particular examination, we can conclude which school has a better performance.

However, extreme values in the data affect the mean. For example, the mean of classes having frequencies more or less the same is a good representative of the data. But, if one class has frequency, say 2, and the five others have frequency 20, 25, 20, 21, 18, then the mean will certainly not reflect the way the data behaves. So, in such cases, the mean is not a good representative of the data.

In problems where individual observations are not important, and we wish to find out a 'typical' observation, the median is more appropriate, e.g., finding the typical productivity rate of workers, average wage in a country, etc. These are situations where extreme values may be there. So, rather than the mean, we take the median as a better measure of central tendency.

In situations which require establishing the most frequent value or most popular item, the mode is the best choice, e.g., to find the most popular T.V. programme being watched, the consumer item in greatest demand, the colour of the vehicle used by most of the people, etc.

#### Remarks :

1. There is an empirical relationship between the three measures of central tendency :

$$3 \text{ Median} = \text{Mode} + 2 \text{ Mean}$$

2. The median of grouped data with unequal class sizes can also be calculated. However, we shall not discuss it here.

## EXERCISE 14.3

1. The following frequency distribution gives the monthly consumption of electricity of 68 consumers of a locality. Find the median, mean and mode of the data and compare them.

Monthly consumption (in units)	Number of consumers
65 - 85	4
85 - 105	5
105 - 125	13
125 - 145	20
145 - 165	14
165 - 185	8
185 - 205	4

2. If the median of the distribution given below is 28.5, find the values of  $x$  and  $y$ .

Class interval	Frequency
0 - 10	5
10 - 20	$x$
20 - 30	20
30 - 40	15
40 - 50	$y$
50 - 60	5
<b>Total</b>	60

3. A life insurance agent found the following data for distribution of ages of 100 policy holders. Calculate the median age, if policies are given only to persons having age 18 years onwards but less than 60 year.

Age (in years)	Number of policy holders
Below 20	2
Below 25	6
Below 30	24
Below 35	45
Below 40	78
Below 45	89
Below 50	92
Below 55	98
Below 60	100

4. The lengths of 40 leaves of a plant are measured correct to the nearest millimetre, and the data obtained is represented in the following table :

Length (in mm)	Number of leaves
118 - 126	3
127 - 135	5
136 - 144	9
145 - 153	12
154 - 162	5
163 - 171	4
172 - 180	2

Find the median length of the leaves.

(**Hint :** The data needs to be converted to continuous classes for finding the median, since the formula assumes continuous classes. The classes then change to 117.5 - 126.5, 126.5 - 135.5, ..., 171.5 - 180.5.)

5. The following table gives the distribution of the life time of 400 neon lamps :

Life time (in hours)	Number of lamps
1500 - 2000	14
2000 - 2500	56
2500 - 3000	60
3000 - 3500	86
3500 - 4000	74
4000 - 4500	62
4500 - 5000	48

Find the median life time of a lamp.

6. 100 surnames were randomly picked up from a local telephone directory and the frequency distribution of the number of letters in the English alphabets in the surnames was obtained as follows:

Number of letters	1 - 4	4 - 7	7 - 10	10 - 13	13 - 16	16 - 19
Number of surnames	6	30	40	16	4	4

Determine the median number of letters in the surnames. Find the mean number of letters in the surnames? Also, find the modal size of the surnames.

7. The distribution below gives the weights of 30 students of a class. Find the median weight of the students.

Weight (in kg)	40 - 45	45 - 50	50 - 55	55 - 60	60 - 65	65 - 70	70 - 75
Number of students	2	3	8	6	6	3	2

### 14.5 Graphical Representation of Cumulative Frequency Distribution

As we all know, pictures speak better than words. A graphical representation helps us in understanding given data at a glance. In Class IX, we have represented the data through bar graphs, histograms and frequency polygons. Let us now represent a cumulative frequency distribution graphically.

For example, let us consider the cumulative frequency distribution given in Table 14.13.

Recall that the values 10, 20, 30, . . . , 100 are the upper limits of the respective class intervals. To represent the data in the table graphically, we mark the upper limits of the class intervals on the horizontal axis ( $x$ -axis) and their corresponding cumulative frequencies on the vertical axis ( $y$ -axis), choosing a convenient scale. The scale may not be the same on both the axis. Let us now plot the points corresponding to the ordered pairs given by (upper limit, corresponding cumulative frequency), i.e., (10, 5), (20, 8), (30, 12), (40, 15), (50, 18), (60, 22), (70, 29), (80, 38), (90, 45), (100, 53) on a graph paper and join them by a free hand smooth curve. The curve we get is called a **cumulative frequency curve**, or an **ogive** (of the less than type). (See Fig. 14.1)

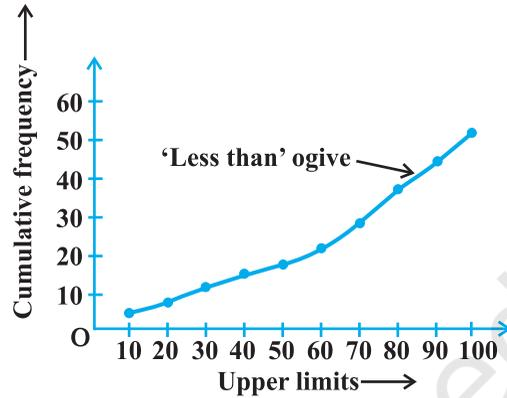


Fig. 14.1

The term 'ogive' is pronounced as 'ojeev' and is derived from the word **ogee**. An ogee is a shape consisting of a concave arc flowing into a convex arc, so forming an S-shaped curve with vertical ends. In architecture, the ogee shape is one of the characteristics of the 14th and 15th century Gothic styles.

Next, again we consider the cumulative frequency distribution given in Table 14.14 and draw its ogive (of the more than type).

Recall that, here 0, 10, 20, . . . , 90 are the lower limits of the respective class intervals 0 - 10, 10 - 20, . . . , 90 - 100. To represent 'the more than type' graphically, we plot the lower limits on the  $x$ -axis and the corresponding cumulative frequencies on the  $y$ -axis. Then we plot the points (lower limit, corresponding cumulative frequency), i.e., (0, 53), (10, 48), (20, 45), (30, 41), (40, 38), (50, 35), (60, 31), (70, 24), (80, 15), (90, 8), on a graph paper, and join them by a free hand smooth curve.

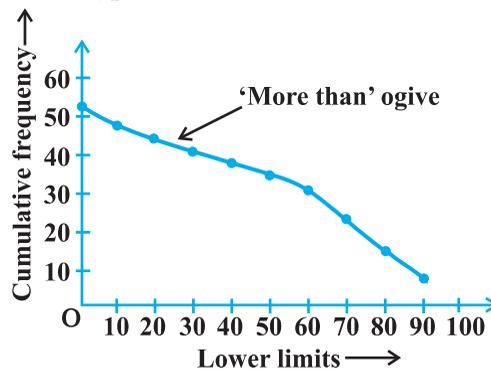


Fig. 14.2

The curve we get is a *cumulative frequency curve*, or an *ogive* (of the more than type). (See Fig. 14.2)

**Remark :** Note that both the ogives (in Fig. 14.1 and Fig. 14.2) correspond to the same data, which is given in Table 14.12.

Now, are the ogives related to the median in any way? Is it possible to obtain the median from these two cumulative frequency curves corresponding to the data in Table 14.12? Let us see.

One obvious way is to locate  $\frac{n}{2} = \frac{53}{2} = 26.5$  on the y-axis (see Fig. 14.3). From this point, draw a line parallel to the x-axis cutting the curve at a point. From this point, draw a perpendicular to the x-axis. The point of intersection of this perpendicular with the x-axis determines the median of the data (see Fig. 14.3).

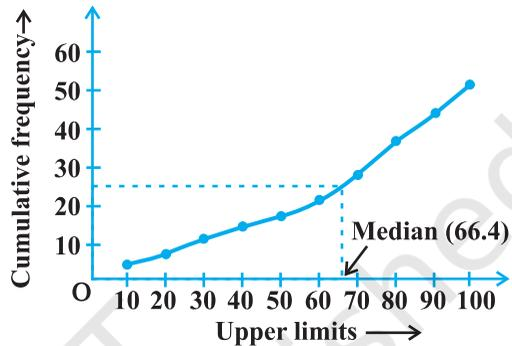


Fig. 14.3

Another way of obtaining the median is the following :

Draw both ogives (i.e., of the less than type and of the more than type) on the same axis. The two ogives will intersect each other at a point. From this point, if we draw a perpendicular on the x-axis, the point at which it cuts the x-axis gives us the median (see Fig. 14.4).

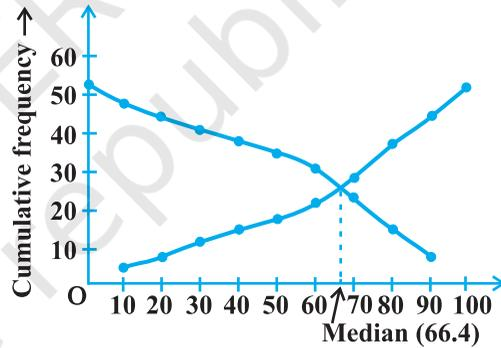


Fig. 14.4

**Example 9 :** The annual profits earned by 30 shops of a shopping complex in a locality give rise to the following distribution :

Profit (Rs in lakhs)	Number of shops (frequency)
More than or equal to 5	30
More than or equal to 10	28
More than or equal to 15	16
More than or equal to 20	14
More than or equal to 25	10
More than or equal to 30	7
More than or equal to 35	3

Draw both ogives for the data above. Hence obtain the median profit.

**Solution :** We first draw the coordinate axes, with lower limits of the profit along the horizontal axis, and the cumulative frequency along the vertical axes. Then, we plot the points (5, 30), (10, 28), (15, 16), (20, 14), (25, 10), (30, 7) and (35, 3). We join these points with a smooth curve to get the 'more than' ogive, as shown in Fig. 14.5.

Now, let us obtain the classes, their frequencies and the cumulative frequency from the table above.

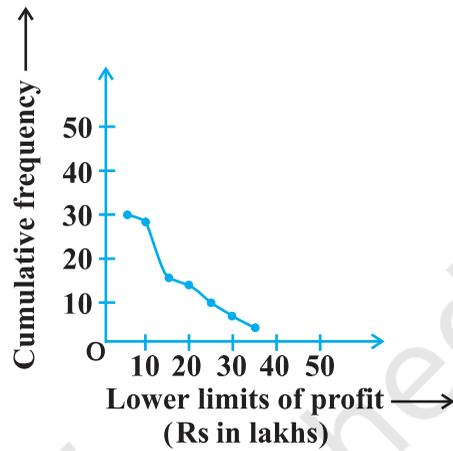


Fig. 14.5

Table 14.17

Classes	5 - 10	10 - 15	15 - 20	20 - 25	25 - 30	30 - 35	35 - 40
No. of shops	2	12	2	4	3	4	3
Cumulative frequency	2	14	16	20	23	27	30

Using these values, we plot the points (10, 2), (15, 14), (20, 16), (25, 20), (30, 23), (35, 27), (40, 30) on the same axes as in Fig. 14.5 to get the 'less than' ogive, as shown in Fig. 14.6.

The abscissa of their point of intersection is nearly 17.5, which is the median. This can also be verified by using the formula. Hence, the median profit (in lakhs) is ₹ 17.5.

**Remark :** In the above examples, it may be noted that the class intervals were continuous. For drawing ogives, it should be ensured that the class intervals are continuous. (Also see constructions of histograms in Class IX)

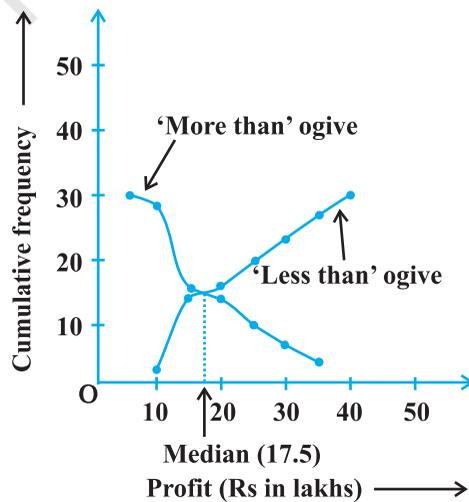


Fig. 14.6

**EXERCISE 14.4**

1. The following distribution gives the daily income of 50 workers of a factory.

Daily income (in ₹)	100 - 120	120 - 140	140 - 160	160 - 180	180 - 200
Number of workers	12	14	8	6	10

Convert the distribution above to a less than type cumulative frequency distribution, and draw its ogive.

2. During the medical check-up of 35 students of a class, their weights were recorded as follows:

Weight (in kg)	Number of students
Less than 38	0
Less than 40	3
Less than 42	5
Less than 44	9
Less than 46	14
Less than 48	28
Less than 50	32
Less than 52	35

Draw a less than type ogive for the given data. Hence obtain the median weight from the graph and verify the result by using the formula.

3. The following table gives production yield per hectare of wheat of 100 farms of a village.

Production yield (in kg/ha)	50 - 55	55 - 60	60 - 65	65 - 70	70 - 75	75 - 80
Number of farms	2	8	12	24	38	16

Change the distribution to a more than type distribution, and draw its ogive.

**14.6 Summary**

In this chapter, you have studied the following points:

1. The mean for grouped data can be found by :

(i) the direct method :  $\bar{x} = \frac{\sum f_i x_i}{\sum f_i}$

- (ii) the assumed mean method :  $\bar{x} = a + \frac{\Sigma f_i d_i}{\Sigma f_i}$
- (iii) the step deviation method :  $\bar{x} = a + \left( \frac{\Sigma f_i u_i}{\Sigma f_i} \right) \times h$ ,

with the assumption that the frequency of a class is centred at its mid-point, called its class mark.

2. The mode for grouped data can be found by using the formula:

$$\text{Mode} = l + \left( \frac{f_1 - f_0}{2f_1 - f_0 - f_2} \right) \times h$$

where symbols have their usual meanings.

3. The cumulative frequency of a class is the frequency obtained by adding the frequencies of all the classes preceding the given class.
4. The median for grouped data is formed by using the formula:

$$\text{Median} = l + \left( \frac{\frac{n}{2} - cf}{f} \right) \times h,$$

where symbols have their usual meanings.

5. Representing a cumulative frequency distribution graphically as a cumulative frequency curve, or an ogive of the less than type and of the more than type.
6. The median of grouped data can be obtained graphically as the  $x$ -coordinate of the point of intersection of the two ogives for this data.

### A NOTE TO THE READER

For calculating mode and median for grouped data, it should be ensured that the class intervals are continuous before applying the formulae. Same condition also apply for construction of an ogive. Further, in case of ogives, the scale may not be the same on both the axes.



1062CH15

# PROBABILITY **15**

*The theory of probabilities and the theory of errors now constitute a formidable body of great mathematical interest and of great practical importance.*

– R.S. Woodward

## 15.1 Introduction

In Class IX, you have studied about experimental (or empirical) probabilities of events which were based on the results of actual experiments. We discussed an experiment of tossing a coin 1000 times in which the frequencies of the outcomes were as follows:

Head : 455      Tail : 545

Based on this experiment, the empirical probability of a head is  $\frac{455}{1000}$ , i.e., 0.455 and that of getting a tail is 0.545. (Also see Example 1, Chapter 15 of Class IX Mathematics Textbook.) Note that these probabilities are based on the results of an actual experiment of tossing a coin 1000 times. For this reason, they are called *experimental* or *empirical probabilities*. In fact, experimental probabilities are based on the results of actual experiments and adequate recordings of the happening of the events. Moreover, these probabilities are only 'estimates'. If we perform the same experiment for another 1000 times, we may get different data giving different probability estimates.

In Class IX, you tossed a coin many times and noted the number of times it turned up heads (or tails) (refer to Activities 1 and 2 of Chapter 15). You also noted that as the number of tosses of the coin increased, the experimental probability of getting a head (or tail) came closer and closer to the number  $\frac{1}{2}$ . Not only you, but many other

persons from different parts of the world have done this kind of experiment and recorded the number of heads that turned up.

For example, the eighteenth century French naturalist Comte de Buffon tossed a coin 4040 times and got 2048 heads. The experimental probability of getting a head, in this case, was  $\frac{2048}{4040}$ , i.e., 0.507. J.E. Kerrich, from Britain, recorded 5067 heads in 10000 tosses of a coin. The experimental probability of getting a head, in this case, was  $\frac{5067}{10000} = 0.5067$ . Statistician Karl Pearson spent some more time, making 24000 tosses of a coin. He got 12012 heads, and thus, the experimental probability of a head obtained by him was 0.5005.

Now, suppose we ask, ‘What will the experimental probability of a head be if the experiment is carried on upto, say, one million times? Or 10 million times? And so on?’ You would intuitively feel that as the number of tosses increases, the experimental probability of a head (or a tail) seems to be settling down around the number 0.5, i.e.,  $\frac{1}{2}$ , which is what we call the *theoretical probability* of getting a head (or getting a tail), as you will see in the next section. In this chapter, we provide an introduction to the theoretical (also called classical) probability of an event, and discuss simple problems based on this concept.

## 15.2 Probability — A Theoretical Approach

Let us consider the following situation :

Suppose a coin is tossed *at random*.

When we speak of a coin, we assume it to be ‘fair’, that is, it is symmetrical so that there is no reason for it to come down more often on one side than the other. We call this property of the coin as being ‘unbiased’. By the phrase ‘random toss’, we mean that the coin is allowed to fall freely without any *bias* or *interference*.

We know, in advance, that the coin can only land in one of two possible ways — either head up or tail up (we dismiss the possibility of its ‘landing’ on its edge, which may be possible, for example, if it falls on sand). We can reasonably assume that each outcome, head or tail, is *as likely to occur as the other*. We refer to this by saying that *the outcomes head and tail, are equally likely*.

For another example of equally likely outcomes, suppose we throw a die once. For us, a die will always mean a fair die. What are the possible outcomes? They are 1, 2, 3, 4, 5, 6. Each number has the same possibility of showing up. So the *equally likely outcomes* of throwing a die are 1, 2, 3, 4, 5 and 6.

Are the outcomes of every experiment equally likely? Let us see.

Suppose that a bag contains 4 red balls and 1 blue ball, and you draw a ball without looking into the bag. What are the outcomes? Are the outcomes — a red ball and a blue ball equally likely? Since there are 4 red balls and only one blue ball, you would agree that you are more likely to get a red ball than a blue ball. So, the outcomes (a red ball or a blue ball) are *not* equally likely. However, the outcome of drawing a ball of any colour from the bag is equally likely. So, all experiments do not necessarily have equally likely outcomes.

However, in this chapter, from now on, we will **assume that all the experiments have equally likely outcomes**.

In Class IX, we defined the experimental or empirical probability  $P(E)$  of an event  $E$  as

$$P(E) = \frac{\text{Number of trials in which the event happened}}{\text{Total number of trials}}$$

The empirical interpretation of probability can be applied to every event associated with an experiment which can be repeated a large number of times. The requirement of repeating an experiment has some limitations, as it may be very expensive or unfeasible in many situations. Of course, it worked well in coin tossing or die throwing experiments. But how about repeating the experiment of launching a satellite in order to compute the empirical probability of its failure during launching, or the repetition of the phenomenon of an earthquake to compute the empirical probability of a multi-storeyed building getting destroyed in an earthquake?

In experiments where we are prepared to make certain assumptions, the repetition of an experiment can be avoided, as the assumptions help in directly calculating the exact (theoretical) probability. The assumption of equally likely outcomes (which is valid in many experiments, as in the two examples above, of a coin and of a die) is one such assumption that leads us to the following definition of probability of an event.

The **theoretical probability** (also called **classical probability**) of an event  $E$ , written as  $P(E)$ , is defined as

$$P(E) = \frac{\text{Number of outcomes favourable to } E}{\text{Number of all possible outcomes of the experiment}},$$

where we assume that the outcomes of the experiment are *equally likely*.

We will briefly refer to theoretical probability as probability.

This definition of probability was given by Pierre Simon Laplace in 1795.

Probability theory had its origin in the 16th century when an Italian physician and mathematician J. Cardan wrote the first book on the subject, *The Book on Games of Chance*. Since its inception, the study of probability has attracted the attention of great mathematicians. James Bernoulli (1654 – 1705), A. de Moivre (1667 – 1754), and Pierre Simon Laplace are among those who made significant contributions to this field. Laplace's *Theorie Analytique des Probabilités*, 1812, is considered to be the greatest contribution by a single person to the theory of probability. In recent years, probability has been used extensively in many areas such as biology, economics, genetics, physics, sociology etc.



**Pierre Simon Laplace**  
(1749 – 1827)

Let us find the probability for some of the events associated with experiments where the equally likely assumption holds.

**Example 1 :** Find the probability of getting a head when a coin is tossed once. Also find the probability of getting a tail.

**Solution :** In the experiment of tossing a coin once, the number of possible outcomes is two — Head (H) and Tail (T). Let E be the event ‘getting a head’. The number of outcomes favourable to E, (i.e., of getting a head) is 1. Therefore,

$$P(E) = P(\text{head}) = \frac{\text{Number of outcomes favourable to E}}{\text{Number of all possible outcomes}} = \frac{1}{2}$$

Similarly, if F is the event ‘getting a tail’, then

$$P(F) = P(\text{tail}) = \frac{1}{2} \quad (\text{Why ?})$$

**Example 2 :** A bag contains a red ball, a blue ball and a yellow ball, all the balls being of the same size. Kritika takes out a ball from the bag without looking into it. What is the probability that she takes out the

- (i) yellow ball?                      (ii) red ball?                      (iii) blue ball?

**Solution :** Kritika takes out a ball from the bag without looking into it. So, it is equally likely that she takes out any one of them.

Let Y be the event ‘the ball taken out is yellow’, B be the event ‘the ball taken out is blue’, and R be the event ‘the ball taken out is red’.

Now, the number of possible outcomes = 3.

(i) The number of outcomes favourable to the event Y = 1.

So,  $P(Y) = \frac{1}{3}$

Similarly, (ii)  $P(R) = \frac{1}{3}$  and (iii)  $P(B) = \frac{1}{3}$ .

**Remarks :**

1. An event having only one outcome of the experiment is called an *elementary event*. In Example 1, both the events E and F are elementary events. Similarly, in Example 2, all the three events, Y, B and R are elementary events.

2. In Example 1, we note that :  $P(E) + P(F) = 1$

In Example 2, we note that :  $P(Y) + P(R) + P(B) = 1$

Observe that **the sum of the probabilities of all the elementary events of an experiment** is 1. This is true in general also.

**Example 3 :** Suppose we throw a die once. (i) What is the probability of getting a number greater than 4 ? (ii) What is the probability of getting a number less than or equal to 4 ?

**Solution :** (i) Here, let E be the event ‘getting a number greater than 4’. The number of possible outcomes is six : 1, 2, 3, 4, 5 and 6, and the outcomes favourable to E are 5 and 6. Therefore, the number of outcomes favourable to E is 2. So,

$$P(E) = P(\text{number greater than 4}) = \frac{2}{6} = \frac{1}{3}$$

(ii) Let F be the event ‘getting a number less than or equal to 4’.

Number of possible outcomes = 6

Outcomes favourable to the event F are 1, 2, 3, 4.

So, the number of outcomes favourable to F is 4.

Therefore,  $P(F) = \frac{4}{6} = \frac{2}{3}$

Are the events E and F in the example above elementary events? No, they are **not** because the event E has 2 outcomes and the event F has 4 outcomes.

**Remarks :** From Example 1, we note that

$$P(E) + P(F) = \frac{1}{2} + \frac{1}{2} = 1 \quad (1)$$

where E is the event ‘getting a head’ and F is the event ‘getting a tail’.

From (i) and (ii) of Example 3, we also get

$$P(E) + P(F) = \frac{1}{3} + \frac{2}{3} = 1 \quad (2)$$

where E is the event ‘getting a number  $>4$ ’ and F is the event ‘getting a number  $\leq 4$ ’.

Note that getting a number *not* greater than 4 is same as getting a number less than or equal to 4, and vice versa.

In (1) and (2) above, is F not the same as ‘not E’? Yes, it is. We denote the event ‘not E’ by  $\bar{E}$ .

So,  $P(E) + P(\text{not } E) = 1$

i.e.,  $P(E) + P(\bar{E}) = 1$ , which gives us  $P(\bar{E}) = 1 - P(E)$ .

**In general, it is true that for an event E,**

$$P(\bar{E}) = 1 - P(E)$$

The event  $\bar{E}$ , representing ‘not E’, is called the **complement** of the event E. We also say that E and  $\bar{E}$  are **complementary** events.

Before proceeding further, let us try to find the answers to the following questions:

- (i) What is the probability of getting a number 8 in a single throw of a die?
- (ii) What is the probability of getting a number less than 7 in a single throw of a die?

**Let us answer (i) :**

We know that there are only six possible outcomes in a single throw of a die. These outcomes are 1, 2, 3, 4, 5 and 6. Since no face of the die is marked 8, so there is no outcome favourable to 8, i.e., the number of such outcomes is zero. In other words, getting 8 in a single throw of a die, is *impossible*.

So,  $P(\text{getting } 8) = \frac{0}{6} = 0$

That is, the probability of an event which is *impossible* to occur is 0. Such an event is called an **impossible event**.

**Let us answer (ii) :**

Since every face of a die is marked with a number less than 7, it is *sure* that we will always get a number less than 7 when it is thrown once. So, the number of favourable outcomes is the same as the number of all possible outcomes, which is 6.

Therefore,  $P(E) = P(\text{getting a number less than 7}) = \frac{6}{6} = 1$

So, the probability of an event which is *sure* (or *certain*) to occur is 1. Such an event is called a **sure event** or a **certain event**.

**Note :** From the definition of the probability  $P(E)$ , we see that the numerator (number of outcomes favourable to the event  $E$ ) is always less than or equal to the denominator (the number of all possible outcomes). Therefore,

$$0 \leq P(E) \leq 1$$

Now, let us take an example related to playing cards. Have you seen a deck of playing cards? It consists of 52 cards which are divided into 4 suits of 13 cards each—spades (♠), hearts (♥), diamonds (♦) and clubs (♣). Clubs and spades are of black colour, while hearts and diamonds are of red colour. The cards in each suit are ace, king, queen, jack, 10, 9, 8, 7, 6, 5, 4, 3 and 2. Kings, queens and jacks are called *face cards*.

**Example 4 :** One card is drawn from a well-shuffled deck of 52 cards. Calculate the probability that the card will

- (i) be an ace,
- (ii) not be an ace.

**Solution :** Well-shuffling ensures *equally likely* outcomes.

- (i) There are 4 aces in a deck. Let  $E$  be the event ‘the card is an ace’.

The number of outcomes favourable to  $E = 4$

The number of possible outcomes = 52 (Why ?)

Therefore,  $P(E) = \frac{4}{52} = \frac{1}{13}$

- (ii) Let  $F$  be the event ‘card drawn is not an ace’.

The number of outcomes favourable to the event  $F = 52 - 4 = 48$  (Why?)

The number of possible outcomes = 52

Therefore, 
$$P(F) = \frac{48}{52} = \frac{12}{13}$$

**Remark :** Note that F is nothing but  $\bar{E}$ . Therefore, we can also calculate P(F) as

follows: 
$$P(F) = P(\bar{E}) = 1 - P(E) = 1 - \frac{1}{13} = \frac{12}{13}.$$

**Example 5 :** Two players, Sangeeta and Reshma, play a tennis match. It is known that the probability of Sangeeta winning the match is 0.62. What is the probability of Reshma winning the match?

**Solution :** Let S and R denote the events that Sangeeta wins the match and Reshma wins the match, respectively.

The probability of Sangeeta's winning =  $P(S) = 0.62$  (given)

The probability of Reshma's winning =  $P(R) = 1 - P(S)$

[As the events R and S are complementary]

$$= 1 - 0.62 = 0.38$$

**Example 6 :** Savita and Hamida are friends. What is the probability that both will have (i) different birthdays? (ii) the same birthday? (ignoring a leap year).

**Solution :** Out of the two friends, one girl, say, Savita's birthday can be any day of the year. Now, Hamida's birthday can also be any day of 365 days in the year.

We assume that these 365 outcomes are equally likely.

(i) If Hamida's birthday is different from Savita's, the number of favourable outcomes for her birthday is  $365 - 1 = 364$

So, 
$$P(\text{Hamida's birthday is different from Savita's birthday}) = \frac{364}{365}$$

(ii)  $P(\text{Savita and Hamida have the same birthday})$

$$= 1 - P(\text{both have different birthdays})$$

$$= 1 - \frac{364}{365} \quad [\text{Using } P(\bar{E}) = 1 - P(E)]$$

$$= \frac{1}{365}$$

**Example 7 :** There are 40 students in Class X of a school of whom 25 are girls and 15 are boys. The class teacher has to select one student as a class representative. She writes the name of each student on a separate card, the cards being identical. Then she puts cards in a bag and stirs them thoroughly. She then draws one card from the bag. What is the probability that the name written on the card is the name of (i) a girl? (ii) a boy?

**Solution :** There are 40 students, and only one name card has to be chosen.

(i) The number of all possible outcomes is 40

The number of outcomes favourable for a card with the name of a girl = 25 (Why?)

$$\text{Therefore, } P(\text{card with name of a girl}) = P(\text{Girl}) = \frac{25}{40} = \frac{5}{8}$$

(ii) The number of outcomes favourable for a card with the name of a boy = 15 (Why?)

$$\text{Therefore, } P(\text{card with name of a boy}) = P(\text{Boy}) = \frac{15}{40} = \frac{3}{8}$$

**Note :** We can also determine  $P(\text{Boy})$ , by taking

$$P(\text{Boy}) = 1 - P(\text{not Boy}) = 1 - P(\text{Girl}) = 1 - \frac{5}{8} = \frac{3}{8}$$

**Example 8 :** A box contains 3 blue, 2 white, and 4 red marbles. If a marble is drawn at *random* from the box, what is the probability that it will be

(i) white?      (ii) blue?      (iii) red?

**Solution :** Saying that a marble is drawn at random is a short way of saying that all the marbles are equally likely to be drawn. Therefore, the

$$\text{number of possible outcomes} = 3 + 2 + 4 = 9 \quad (\text{Why?})$$

Let  $W$  denote the event 'the marble is white',  $B$  denote the event 'the marble is blue' and  $R$  denote the event 'marble is red'.

(i) The number of outcomes favourable to the event  $W = 2$

$$\text{So, } P(W) = \frac{2}{9}$$

$$\text{Similarly, } (ii) P(B) = \frac{3}{9} = \frac{1}{3} \quad \text{and} \quad (iii) P(R) = \frac{4}{9}$$

Note that  $P(W) + P(B) + P(R) = 1$ .

**Example 9 :** Harpreet tosses two different coins simultaneously (say, one is of ₹ 1 and other of ₹ 2). What is the probability that she gets *at least* one head?

**Solution :** We write H for ‘head’ and T for ‘tail’. When two coins are tossed simultaneously, the possible outcomes are (H, H), (H, T), (T, H), (T, T), which are all *equally likely*. Here (H, H) means head up on the first coin (say on ₹ 1) and head up on the second coin (₹ 2). Similarly (H, T) means head up on the first coin and tail up on the second coin and so on.

The outcomes favourable to the event E, ‘at least one head’ are (H, H), (H, T) and (T, H). (Why?)

So, the number of outcomes favourable to E is 3.

Therefore,  $P(E) = \frac{3}{4}$

i.e., the probability that Harpreet gets at least one head is  $\frac{3}{4}$ .

**Note :** You can also find  $P(E)$  as follows:

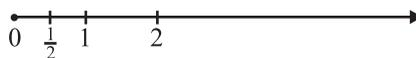
$$P(E) = 1 - P(\bar{E}) = 1 - \frac{1}{4} = \frac{3}{4} \quad \left( \text{Since } P(\bar{E}) = P(\text{no head}) = \frac{1}{4} \right)$$

Did you observe that in all the examples discussed so far, the number of possible outcomes in each experiment was finite? If not, check it now.

There are many experiments in which the outcome is any number between two given numbers, or in which the outcome is every point within a circle or rectangle, etc. Can you now count the number of all possible outcomes? As you know, this is not possible since there are infinitely many numbers between two given numbers, or there are infinitely many points within a circle. So, the definition of (theoretical) probability which you have learnt so far cannot be applied in the present form. What is the way out? To answer this, let us consider the following example :

**Example 10\* :** In a musical chair game, the person playing the music has been advised to stop playing the music at any time within 2 minutes after she starts playing. What is the probability that the music will stop within the first half-minute after starting?

**Solution :** Here the possible outcomes are all the numbers between 0 and 2. This is the portion of the number line from 0 to 2 (see Fig. 15.1).



**Fig. 15.1**

\* Not from the examination point of view.

Let E be the event that ‘the music is stopped within the first half-minute’.

The outcomes favourable to E are points on the number line from 0 to  $\frac{1}{2}$ .

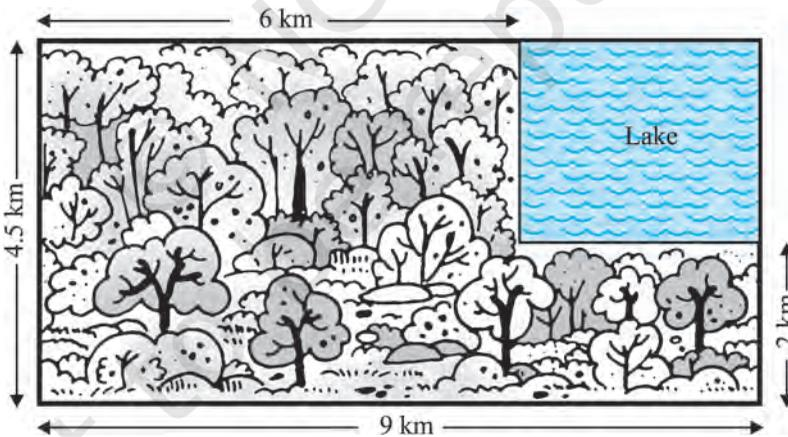
The distance from 0 to 2 is 2, while the distance from 0 to  $\frac{1}{2}$  is  $\frac{1}{2}$ .

Since all the outcomes are equally likely, we can argue that, of the total distance of 2, the distance favourable to the event E is  $\frac{1}{2}$ .

$$\text{So, } P(E) = \frac{\text{Distance favourable to the event E}}{\text{Total distance in which outcomes can lie}} = \frac{\frac{1}{2}}{2} = \frac{1}{4}$$

Can we now extend the idea of Example 10 for finding the probability as the ratio of the favourable area to the total area?

**Example 11\*** : A missing helicopter is reported to have crashed somewhere in the rectangular region shown in Fig. 15.2. What is the probability that it crashed inside the lake shown in the figure?



**Fig. 15.2**

**Solution :** The helicopter is equally likely to crash anywhere in the region.

Area of the entire region where the helicopter can crash

$$= (4.5 \times 9) \text{ km}^2 = 40.5 \text{ km}^2$$

\* Not from the examination point of view.

Area of the lake =  $(2.5 \times 3) \text{ km}^2 = 7.5 \text{ km}^2$

Therefore,  $P(\text{helicopter crashed in the lake}) = \frac{7.5}{40.5} = \frac{75}{405} = \frac{5}{27}$

**Example 12 :** A carton consists of 100 shirts of which 88 are good, 8 have minor defects and 4 have major defects. Jimmy, a trader, will only accept the shirts which are good, but Sujatha, another trader, will only reject the shirts which have major defects. One shirt is drawn at random from the carton. What is the probability that

- (i) it is acceptable to Jimmy?
- (ii) it is acceptable to Sujatha?

**Solution :** One shirt is drawn at random from the carton of 100 shirts. Therefore, there are 100 equally likely outcomes.

- (i) The number of outcomes favourable (i.e., acceptable) to Jimmy = 88 (Why?)

Therefore,  $P(\text{shirt is acceptable to Jimmy}) = \frac{88}{100} = 0.88$

- (ii) The number of outcomes favourable to Sujatha =  $88 + 8 = 96$  (Why?)

So,  $P(\text{shirt is acceptable to Sujatha}) = \frac{96}{100} = 0.96$

**Example 13 :** Two dice, one blue and one grey, are thrown at the same time. Write down all the possible outcomes. What is the probability that the sum of the two numbers appearing on the top of the dice is

- (i) 8?                      (ii) 13?                      (iii) less than or equal to 12?

**Solution :** When the blue die shows '1', the grey die could show any one of the numbers 1, 2, 3, 4, 5, 6. The same is true when the blue die shows '2', '3', '4', '5' or '6'. The possible outcomes of the experiment are listed in the table below; the first number in each ordered pair is the number appearing on the blue die and the second number is that on the grey die.

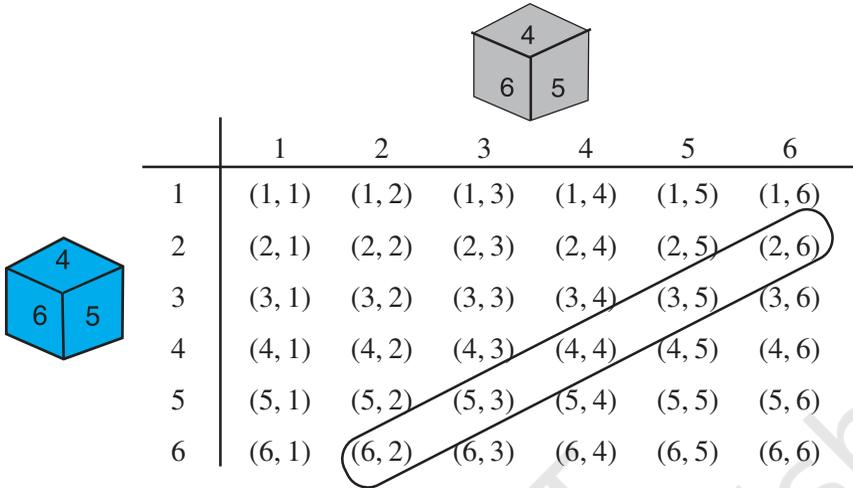


Fig. 15.3

Note that the pair (1, 4) is different from (4, 1). (Why?)

So, the number of possible outcomes =  $6 \times 6 = 36$ .

- (i) The outcomes favourable to the event ‘the sum of the two numbers is 8’ denoted by E, are: (2, 6), (3, 5), (4, 4), (5, 3), (6, 2) (see Fig. 15.3)

i.e., the number of outcomes favourable to E = 5.

Hence, 
$$P(E) = \frac{5}{36}$$

- (ii) As you can see from Fig. 15.3, there is no outcome favourable to the event F, ‘the sum of two numbers is 13’.

So, 
$$P(F) = \frac{0}{36} = 0$$

- (iii) As you can see from Fig. 15.3, all the outcomes are favourable to the event G, ‘sum of two numbers  $\leq 12$ ’.

So, 
$$P(G) = \frac{36}{36} = 1$$

**EXERCISE 15.1**

1. Complete the following statements:
  - (i) Probability of an event E + Probability of the event 'not E' = \_\_\_\_\_ .
  - (ii) The probability of an event that cannot happen is \_\_\_\_\_ . Such an event is called \_\_\_\_\_ .
  - (iii) The probability of an event that is certain to happen is \_\_\_\_\_ . Such an event is called \_\_\_\_\_ .
  - (iv) The sum of the probabilities of all the elementary events of an experiment is \_\_\_\_\_ .
  - (v) The probability of an event is greater than or equal to \_\_\_\_\_ and less than or equal to \_\_\_\_\_ .
2. Which of the following experiments have equally likely outcomes? Explain.
  - (i) A driver attempts to start a car. The car starts or does not start.
  - (ii) A player attempts to shoot a basketball. She/he shoots or misses the shot.
  - (iii) A trial is made to answer a true-false question. The answer is right or wrong.
  - (iv) A baby is born. It is a boy or a girl.
3. Why is tossing a coin considered to be a fair way of deciding which team should get the ball at the beginning of a football game?
4. Which of the following cannot be the probability of an event?  
(A)  $\frac{2}{3}$       (B)  $-1.5$       (C)  $15\%$       (D)  $0.7$
5. If  $P(E) = 0.05$ , what is the probability of 'not E'?
6. A bag contains lemon flavoured candies only. Malini takes out one candy without looking into the bag. What is the probability that she takes out
  - (i) an orange flavoured candy?
  - (ii) a lemon flavoured candy?
7. It is given that in a group of 3 students, the probability of 2 students not having the same birthday is 0.992. What is the probability that the 2 students have the same birthday?
8. A bag contains 3 red balls and 5 black balls. A ball is drawn at random from the bag. What is the probability that the ball drawn is (i) red ? (ii) not red?
9. A box contains 5 red marbles, 8 white marbles and 4 green marbles. One marble is taken out of the box at random. What is the probability that the marble taken out will be (i) red ? (ii) white ? (iii) not green?

10. A piggy bank contains hundred 50p coins, fifty ₹ 1 coins, twenty ₹ 2 coins and ten ₹ 5 coins. If it is equally likely that one of the coins will fall out when the bank is turned upside down, what is the probability that the coin (i) will be a 50 p coin ? (ii) will not be a ₹ 5 coin?

11. Gopi buys a fish from a shop for his aquarium. The shopkeeper takes out one fish at random from a tank containing 5 male fish and 8 female fish (see Fig. 15.4). What is the probability that the fish taken out is a male fish?



Fig. 15.4

12. A game of chance consists of spinning an arrow which comes to rest pointing at one of the numbers 1, 2, 3, 4, 5, 6, 7, 8 (see Fig. 15.5), and these are equally likely outcomes. What is the probability that it will point at



Fig. 15.5

- (i) 8 ?  
 (ii) an odd number?  
 (iii) a number greater than 2?  
 (iv) a number less than 9?
13. A die is thrown once. Find the probability of getting  
 (i) a prime number;      (ii) a number lying between 2 and 6;      (iii) an odd number.
14. One card is drawn from a well-shuffled deck of 52 cards. Find the probability of getting  
 (i) a king of red colour      (ii) a face card      (iii) a red face card  
 (iv) the jack of hearts      (v) a spade      (vi) the queen of diamonds
15. Five cards—the ten, jack, queen, king and ace of diamonds, are well-shuffled with their face downwards. One card is then picked up at random.  
 (i) What is the probability that the card is the queen?  
 (ii) If the queen is drawn and put aside, what is the probability that the second card picked up is (a) an ace? (b) a queen?
16. 12 defective pens are accidentally mixed with 132 good ones. It is not possible to just look at a pen and tell whether or not it is defective. One pen is taken out at random from this lot. Determine the probability that the pen taken out is a good one.
17. (i) A lot of 20 bulbs contain 4 defective ones. One bulb is drawn at random from the lot. What is the probability that this bulb is defective?  
 (ii) Suppose the bulb drawn in (i) is not defective and is not replaced. Now one bulb is drawn at random from the rest. What is the probability that this bulb is not defective ?
18. A box contains 90 discs which are numbered from 1 to 90. If one disc is drawn at random from the box, find the probability that it bears (i) a two-digit number (ii) a perfect square number (iii) a number divisible by 5.

19. A child has a die whose six faces show the letters as given below:



The die is thrown once. What is the probability of getting (i) A? (ii) D?

- 20\*. Suppose you drop a die at random on the rectangular region shown in Fig. 15.6. What is the probability that it will land inside the circle with diameter 1 m?

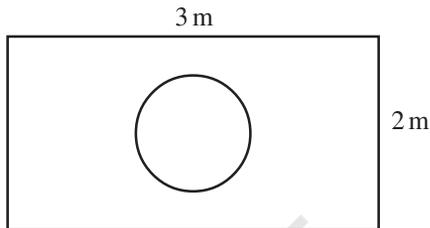


Fig. 15.6

21. A lot consists of 144 ball pens of which 20 are defective and the others are good. Nuri will buy a pen if it is good, but will not buy if it is defective. The shopkeeper draws one pen at random and gives it to her. What is the probability that
- She will buy it ?
  - She will not buy it ?
22. Refer to Example 13. (i) Complete the following table:

<b>Event:</b> <b>'Sum on 2 dice'</b>	2	3	4	5	6	7	8	9	10	11	12
<b>Probability</b>	$\frac{1}{36}$						$\frac{5}{36}$				$\frac{1}{36}$

- A student argues that 'there are 11 possible outcomes 2, 3, 4, 5, 6, 7, 8, 9, 10, 11 and 12. Therefore, each of them has a probability  $\frac{1}{11}$ . Do you agree with this argument? Justify your answer.
23. A game consists of tossing a one rupee coin 3 times and noting its outcome each time. Hanif wins if all the tosses give the same result i.e., three heads or three tails, and loses otherwise. Calculate the probability that Hanif will lose the game.
24. A die is thrown twice. What is the probability that
- 5 will not come up either time?
  - 5 will come up at least once?
- [Hint : Throwing a die twice and throwing two dice simultaneously are treated as the same experiment]

\* Not from the examination point of view.

25. Which of the following arguments are correct and which are not correct? Give reasons for your answer.
- If two coins are tossed simultaneously there are three possible outcomes—two heads, two tails or one of each. Therefore, for each of these outcomes, the probability is  $\frac{1}{3}$ .
  - If a die is thrown, there are two possible outcomes—an odd number or an even number. Therefore, the probability of getting an odd number is  $\frac{1}{2}$ .

### EXERCISE 15.2 (Optional)\*

- Two customers Shyam and Ekta are visiting a particular shop in the same week (Tuesday to Saturday). Each is equally likely to visit the shop on any day as on another day. What is the probability that both will visit the shop on (i) the same day? (ii) consecutive days? (iii) different days?
- A die is numbered in such a way that its faces show the numbers 1, 2, 2, 3, 3, 6. It is thrown two times and the total score in two throws is noted. Complete the following table which gives a few values of the total score on the two throws:

		Number in first throw					
		1	2	2	3	3	6
Number in second throw	1	2	3	3	4	4	7
	2	3	4	4	5	5	8
	2					5	
	3						
	3			5			9
	6	7	8	8	9	9	12

What is the probability that the total score is

- even?
  - 6?
  - at least 6?
- A bag contains 5 red balls and some blue balls. If the probability of drawing a blue ball is *double* that of a red ball, determine the number of blue balls in the bag.
  - A box contains 12 balls out of which  $x$  are black. If one ball is drawn at random from the box, what is the probability that it will be a black ball?  
If 6 more black balls are put in the box, the probability of drawing a black ball is now double of what it was before. Find  $x$ .

\* These exercises are not from the examination point of view.

5. A jar contains 24 marbles, some are green and others are blue. If a marble is drawn at random from the jar, the probability that it is green is  $\frac{2}{3}$ . Find the number of blue balls in the jar.

### 15.3 Summary

In this chapter, you have studied the following points :

1. The difference between experimental probability and theoretical probability.
2. The theoretical (classical) probability of an event E, written as P(E), is defined as

$$P(E) = \frac{\text{Number of outcomes favourable to E}}{\text{Number of all possible outcomes of the experiment}}$$

where we assume that the outcomes of the experiment are equally likely.

3. The probability of a sure event (or certain event) is 1.
4. The probability of an impossible event is 0.
5. The probability of an event E is a number P(E) such that
 
$$0 \leq P(E) \leq 1$$
6. An event having only one outcome is called an elementary event. The sum of the probabilities of all the elementary events of an experiment is 1.
7. For any event E,  $P(E) + P(\bar{E}) = 1$ , where  $\bar{E}$  stands for 'not E'. E and  $\bar{E}$  are called complementary events.

#### A NOTE TO THE READER

The experimental or empirical probability of an event is based on what has actually happened while the theoretical probability of the event attempts to predict what will happen on the basis of certain assumptions. As the number of trials in an experiment, go on increasing we may expect the experimental and theoretical probabilities to be nearly the same.

## ANSWERS/HINTS

### EXERCISE 1.1

- (i) 45                      (ii) 196                      (iii) 51
- An integer can be of the form  $6q, 6q + 1, 6q + 2, 6q + 3, 6q + 4$  or  $6q + 5$ .
- 8 columns
- An integer can be of the form  $3q, 3q + 1$  or  $3q + 2$ . Square all of these integers.
- An integer can be of the form  $9q, 9q + 1, 9q + 2, 9q + 3, \dots$ , or  $9q + 8$ .

### EXERCISE 1.2

- (i)  $2^2 \times 5 \times 7$                       (ii)  $2^2 \times 3 \times 13$                       (iii)  $3^2 \times 5^2 \times 17$   
(iv)  $5 \times 7 \times 11 \times 13$                       (v)  $17 \times 19 \times 23$
- (i) LCM = 182; HCF = 13                      (ii) LCM = 23460; HCF = 2                      (iii) LCM = 3024; HCF = 6
- (i) LCM = 420; HCF = 3                      (ii) LCM = 11339; HCF = 1                      (iii) LCM = 1800; HCF = 1
- 22338                      7. 36 minutes

### EXERCISE 1.4

- (i) Terminating                      (ii) Terminating  
(iii) Non-terminating repeating                      (iv) Terminating  
(v) Non-terminating repeating                      (vi) Terminating  
(vii) Non-terminating repeating                      (viii) Terminating  
(ix) Terminating                      (x) Non-terminating repeating
- (i) 0.00416                      (ii) 2.125                      (iv) 0.009375  
(vi) 0.115                      (viii) 0.4                      (ix) 0.7

3. (i) Rational, prime factors of  $q$  will be either 2 or 5 or both only.  
 (ii) Not rational  
 (iii) Rational, prime factors of  $q$  will also have a factor other than 2 or 5.

### EXERCISE 2.1

1. (i) No zeroes      (ii) 1      (iii) 3      (iv) 2      (v) 4      (vi) 3

### EXERCISE 2.2

1. (i)  $-2, 4$       (ii)  $\frac{1}{2}, \frac{1}{2}$       (iii)  $-\frac{1}{3}, \frac{3}{2}$   
 (iv)  $-2, 0$       (v)  $-\sqrt{15}, \sqrt{15}$       (vi)  $-1, \frac{4}{3}$
2. (i)  $4x^2 - x - 4$       (ii)  $3x^2 - 3\sqrt{2}x + 1$       (iii)  $x^2 + \sqrt{5}$   
 (iv)  $x^2 - x + 1$       (v)  $4x^2 + x + 1$       (vi)  $x^2 - 4x + 1$

### EXERCISE 2.3

1. (i) Quotient =  $x - 3$  and remainder =  $7x - 9$   
 (ii) Quotient =  $x^2 + x - 3$  and remainder = 8  
 (iii) Quotient =  $-x^2 - 2$  and remainder =  $-5x + 10$
2. (i) Yes    (ii) Yes    (iii) No      3.  $-1, -1$       4.  $g(x) = x^2 - x + 1$
5. (i)  $p(x) = 2x^2 - 2x + 14, g(x) = 2, q(x) = x^2 - x + 7, r(x) = 0$   
 (ii)  $p(x) = x^3 + x^2 + x + 1, g(x) = x^2 - 1, q(x) = x + 1, r(x) = 2x + 2$   
 (iii)  $p(x) = x^3 + 2x^2 - x + 2, g(x) = x^2 - 1, q(x) = x + 2, r(x) = 4$

There can be several examples in each of (i), (ii) and (iii).

### EXERCISE 2.4 (Optional)\*

2.  $x^3 - 2x^2 - 7x + 14$       3.  $a = 1, b = \pm\sqrt{2}$   
 4.  $-5, 7$       5.  $k = 5$  and  $a = -5$

### EXERCISE 3.1

1. Algebraically the two situations can be represented as follows:  
 $x - 7y + 42 = 0; x - 3y - 6 = 0$ , where  $x$  and  $y$  are respectively the present ages of Aftab and

his daughter. To represent the situations graphically, you can draw the graphs of these two linear equations.

2. Algebraically the two situations can be represented as follows:

$x + 2y = 1300$ ;  $x + 3y = 1300$ , where  $x$  and  $y$  are respectively the costs (in ₹) of a bat and a ball. To represent the situations graphically, you can draw the graphs of these two linear equations.

3. Algebraically the two situations can be represented as follows:

$2x + y = 160$ ;  $4x + 2y = 300$ , where  $x$  and  $y$  are respectively the prices (in ₹ per kg) of apples and grapes. To represent the situations graphically, you can draw the graphs of these two linear equations.

### EXERCISE 3.2

1. (i) Required pair of linear equations is

$x + y = 10$ ;  $x - y = 4$ , where  $x$  is the number of girls and  $y$  is the number of boys.

To solve graphically draw the graphs of these equations on the same axes on graph paper.

Girls = 7, Boys = 3.

- (ii) Required pair of linear equations is

$5x + 7y = 50$ ;  $7x + 5y = 46$ , where  $x$  and  $y$  represent the cost (in ₹) of a pencil and of a pen respectively.

To solve graphically, draw the graphs of these equations on the same axes on graph paper.

Cost of one pencil = ₹ 3, Cost of one pen = ₹ 5

2. (i) Intersect at a point      (ii) Coincident      (iii) Parallel  
 3. (i) Consistent      (ii) Inconsistent      (iii) Consistent  
 (iv) Consistent      (v) Consistent  
 4. (i) Consistent      (ii) Inconsistent      (iii) Consistent      (iv) Inconsistent

The solution of (i) above, is given by  $y = 5 - x$ , where  $x$  can take any value, i.e., there are infinitely many solutions.

The solution of (iii) above is  $x = 2$ ,  $y = 2$ , i.e., unique solution.

5. Length = 20 m and breadth = 16 m.  
 6. One possible answer for the three parts:  
 (i)  $3x + 2y - 7 = 0$       (ii)  $2x + 3y - 12 = 0$       (iii)  $4x + 6y - 16 = 0$   
 7. Vertices of the triangle are  $(-1, 0)$ ,  $(4, 0)$  and  $(2, 3)$ .

## EXERCISE 3.3

1. (i)  $x = 9, y = 5$  (ii)  $s = 9, t = 6$  (iii)  $y = 3x - 3$ ,  
where  $x$  can take any value, i.e., infinitely many solutions.
- (iv)  $x = 2, y = 3$  (v)  $x = 0, y = 0$  (vi)  $x = 2, y = 3$
2.  $x = -2, y = 5; m = -1$
3. (i)  $x - y = 26, x = 3y$ , where  $x$  and  $y$  are two numbers ( $x > y$ );  $x = 39, y = 13$ .  
(ii)  $x - y = 18, x + y = 180$ , where  $x$  and  $y$  are the measures of the two angles in degrees;  
 $x = 99, y = 81$ .  
(iii)  $7x + 6y = 3800, 3x + 5y = 1750$ , where  $x$  and  $y$  are the costs (in ₹) of one bat and one  
ball respectively;  $x = 500, y = 50$ .  
(iv)  $x + 10y = 105, x + 15y = 155$ , where  $x$  is the fixed charge (in ₹) and  $y$  is the charge (in  
₹ per km);  $x = 5, y = 10$ ; ₹ 255.  
(v)  $11x - 9y + 4 = 0, 6x - 5y + 3 = 0$ , where  $x$  and  $y$  are numerator and denominator of the  
fraction;  $\frac{7}{9}$  ( $x = 7, y = 9$ ).  
(vi)  $x - 3y - 10 = 0, x - 7y + 30 = 0$ , where  $x$  and  $y$  are the ages in years of Jacob and his  
son;  $x = 40, y = 10$ .

## EXERCISE 3.4

1. (i)  $x = \frac{19}{5}, y = \frac{6}{5}$  (ii)  $x = 2, y = 1$  (iii)  $x = \frac{9}{13}, y = -\frac{5}{13}$
- (iv)  $x = 2, y = -3$
2. (i)  $x - y + 2 = 0, 2x - y - 1 = 0$ , where  $x$  and  $y$  are the numerator and denominator of the  
fraction;  $\frac{3}{5}$ .  
(ii)  $x - 3y + 10 = 0, x - 2y - 10 = 0$ , where  $x$  and  $y$  are the ages (in years) of Nuri and Sonu  
respectively. Age of Nuri ( $x$ ) = 50, Age of Sonu ( $y$ ) = 20.  
(iii)  $x + y = 9, 8x - y = 0$ , where  $x$  and  $y$  are respectively the tens and units digits of the  
number; 18.  
(iv)  $x + 2y = 40, x + y = 25$ , where  $x$  and  $y$  are respectively the number of ₹ 50 and ₹ 100  
notes;  $x = 10, y = 15$ .  
(v)  $x + 4y = 27, x + 2y = 21$ , where  $x$  is the fixed charge (in ₹) and  $y$  is the additional  
charge (in ₹) per day;  $x = 15, y = 3$ .

## EXERCISE 3.5

- No solution
  - Unique solution;  $x = 2, y = 1$
  - Infinitely many solutions
  - Unique solution;  $x = 4, y = -1$
- $a = 5, b = 1$
  - $k = 2$
  - $x = -2, y = 5$
- $x + 20y = 1000, x + 26y = 1180$ , where  $x$  is the fixed charges (in ₹) and  $y$  is the charges (in ₹) for food per day;  $x = 400, y = 30$ .
  - $3x - y - 3 = 0, 4x - y - 8 = 0$ , where  $x$  and  $y$  are the numerator and denominator of the fraction;  $\frac{5}{12}$ .
  - $3x - y = 40, 2x - y = 25$ , where  $x$  and  $y$  are the number of right answers and wrong answers respectively; 20.
  - $u - v = 20, u + v = 100$ , where  $u$  and  $v$  are the speeds (in km/h) of the two cars;  $u = 60, v = 40$ .
  - $3x - 5y - 6 = 0, 2x + 3y - 61 = 0$ , where  $x$  and  $y$  are respectively the length and breadth (in units) of the rectangle; length ( $x$ ) = 17, breadth ( $y$ ) = 9.

## EXERCISE 3.6

- $x = \frac{1}{2}, y = \frac{1}{3}$
  - $x = 4, y = 9$
  - $x = \frac{1}{5}, y = -2$
  - $x = 4, y = 5$
  - $x = 1, y = 1$
  - $x = 1, y = 2$
  - $x = 3, y = 2$
  - $x = 1, y = 1$
- $u + v = 10, u - v = 2$ , where  $u$  and  $v$  are respectively speeds (in km/h) of rowing and current;  $u = 6, v = 4$ .
  - $\frac{2}{n} + \frac{5}{m} = \frac{1}{4}, \frac{3}{n} + \frac{6}{m} = \frac{1}{3}$ , where  $n$  and  $m$  are the number of days taken by 1 woman and 1 man to finish the embroidery work;  $n = 18, m = 36$ .
  - $\frac{60}{u} + \frac{240}{v} = 4, \frac{100}{u} + \frac{200}{v} = \frac{25}{6}$ , where  $u$  and  $v$  are respectively the speeds (in km/h) of the train and bus;  $u = 60, v = 80$ .

## EXERCISE 3.7 (Optional)\*

- Age of Ani is 19 years and age of Biju is 16 years or age of Ani 21 years and age of Biju 24 years.
- ₹ 40, ₹ 170. Let the money with the first person (in ₹) be  $x$  and the money with the second person (in ₹) be  $y$ .  
 $x + 100 = 2(y - 100), y + 10 = 6(x - 10)$

3. 600km                      4. 36                      5.  $\angle A = 20^\circ$ ,  $\angle B = 40^\circ$ ,  $\angle C = 120^\circ$
6. Coordinates of the vertices of the triangle are (1, 0), (0, -3), (0, -5).
7. (i)  $x = 1$ ,  $y = -1$                       (ii)  $x = \frac{c(a-b)-b}{a^2-b^2}$ ,  $y = \frac{c(a-b)+a}{a^2-b^2}$
- (iii)  $x = a$ ,  $y = b$                       (iv)  $x = a + b$ ,  $y = -\frac{2ab}{a+b}$                       (v)  $x = 2$ ,  $y = 1$
8.  $\angle A = 120^\circ$ ,  $\angle B = 70^\circ$ ,  $\angle C = 60^\circ$ ,  $\angle D = 110^\circ$

### EXERCISE 4.1

1. (i) Yes                      (ii) Yes                      (iii) No                      (iv) Yes  
 (v) Yes                      (vi) No                      (vii) No                      (viii) Yes
2. (i)  $2x^2 + x - 528 = 0$ , where  $x$  is breadth (in metres) of the plot.  
 (ii)  $x^2 + x - 306 = 0$ , where  $x$  is the smaller integer.  
 (iii)  $x^2 + 32x - 273 = 0$ , where  $x$  (in years) is the present age of Rohan.  
 (iv)  $u^2 - 8u - 1280 = 0$ , where  $u$  (in km/h) is the speed of the train.

### EXERCISE 4.2

1. (i) -2, 5                      (ii)  $-2, \frac{3}{2}$                       (iii)  $-\frac{5}{\sqrt{2}}, -\sqrt{2}$   
 (iv)  $\frac{1}{4}, \frac{1}{4}$                       (v)  $\frac{1}{10}, \frac{1}{10}$
2. (i) 9, 36                      (ii) 25, 30
3. Numbers are 13 and 14.                      4. Positive integers are 13 and 14.
5. 5 cm and 12 cm                      6. Number of articles = 6, Cost of each article = ₹ 15

### EXERCISE 4.3

1. (i)  $\frac{1}{2}, 3$                       (ii)  $\frac{-1-\sqrt{33}}{4}, \frac{-1+\sqrt{33}}{4}$                       (iii)  $-\frac{\sqrt{3}}{2}, -\frac{\sqrt{3}}{2}$   
 (iv) Do not exist
2. Same as 1                      3. (i)  $\frac{3-\sqrt{13}}{2}, \frac{3+\sqrt{13}}{2}$                       (ii) 1, 2                      4. 7 years



- (ix) No (x) Yes.  $d = a; 5a, 6a, 7a$   
 (xi) No (xii) Yes.  $d = \sqrt{2}; \sqrt{50}, \sqrt{72}, \sqrt{98}$   
 (xiii) No (xiv) No (xv) Yes.  $d = 24; 97, 121, 145$

### EXERCISE 5.2

1. (i)  $a_n = 28$  (ii)  $d = 2$  (iii)  $a = 46$  (iv)  $n = 10$  (v)  $a_n = 3.5$   
 2. (i) C (ii) B  
 3. (i)  $\boxed{14}$  (ii)  $\boxed{18}, \boxed{8}$  (iii)  $\boxed{6\frac{1}{2}}, \boxed{8}$   
 (iv)  $\boxed{-2}, \boxed{0}, \boxed{2}, \boxed{4}$  (v)  $\boxed{53}, \boxed{23}, \boxed{8}, \boxed{-7}$   
 4. 16th term 5. (i) 34 (ii) 27  
 6. No 7. 178 8. 64  
 9. 5th term 10. 1 11. 65th term  
 12. 100 13. 128 14. 60  
 15. 13 16. 4, 10, 16, 22, ...  
 17. 20th term from the last term is 158.  
 18. -13, -8, -3 19. 11th year 20. 10

### EXERCISE 5.3

1. (i) 245 (ii) -180 (iii) 5505 (iv)  $\frac{33}{20}$   
 2. (i)  $1046\frac{1}{2}$  (ii) 286 (iii) -8930  
 3. (i)  $n = 16, S_n = 440$  (ii)  $d = \frac{7}{3}, S_{13} = 273$  (iii)  $a = 4, S_{12} = 246$   
 (iv)  $d = -1, a_{10} = 8$  (v)  $a = -\frac{35}{3}, a_9 = \frac{85}{3}$  (vi)  $n = 5, a_n = 34$   
 (vii)  $n = 6, d = \frac{54}{5}$  (viii)  $n = 7, a = -8$  (ix)  $d = 6$   
 (x)  $a = 4$

4. 12. By putting  $a = 9, d = 8, S = 636$  in the formula  $S = \frac{n}{2}[2a + (n - 1)d]$ , we get a quadratic equation  $4n^2 + 5n - 636 = 0$ . On solving, we get  $n = -\frac{53}{4}, 12$ . Out of these two roots only one root 12 is admissible.
5.  $n = 16, d = \frac{8}{3}$                       6.  $n = 38, S = 6973$                       7. Sum = 1661
8.  $S_{51} = 5610$                       9.  $n^2$                       10. (i)  $S_{15} = 525$  (ii)  $S_{15} = -465$
11.  $S_1 = 3, S_2 = 4; a_2 = S_2 - S_1 = 1; S_3 = 3, a_3 = S_3 - S_2 = -1,$   
 $a_{10} = S_{10} - S_9 = -15; a_n = S_n - S_{n-1} = 5 - 2n.$
12. 4920                      13. 960                      14. 625                      15. ₹ 27750
16. Values of the prizes (in ₹) are 160, 140, 120, 100, 80, 60, 40.
17. 234                      18. 143 cm
19. 16 rows, 5 logs are placed in the top row. By putting  $S = 200, a = 20, d = -1$  in the formula  $S = \frac{n}{2}[2a + (n - 1)d]$ , we get,  $41n - n^2 = 400$ . On solving,  $n = 16, 25$ . Therefore, the number of rows is either 16 or 25.  $a_{25} = a + 24d = -4$   
 i.e., number of logs in 25th row is  $-4$  which is not possible. Therefore  $n = 25$  is not possible. For  $n = 16, a_{16} = 5$ . Therefore, there are 16 rows and 5 logs placed in the top row.
20. 370m

**EXERCISE 5.4 (Optional)\***

1. 32nd term                      2.  $S_{16} = 20, 76$                       3. 385 cm
4. 35                      5.  $750 \text{ m}^3$

**EXERCISE 6.1**

1. (i) Similar                      (ii) Similar                      (iii) Equilateral  
 (iv) Equal, Proportional                      3. No

**EXERCISE 6.2**

1. (i) 2 cm                      (ii) 2.4 cm
2. (i) No                      (ii) Yes                      (iii) Yes
9. Through O, draw a line parallel to DC, intersecting AD and BC at E and F respectively.

## EXERCISE 6.3

1. (i) Yes. AAA,  $\triangle ABC \sim \triangle PQR$                       (ii) Yes. SSS,  $\triangle ABC \sim \triangle QRP$   
     (iii) No    (iv) Yes. SAS,  $\triangle MNL \sim \triangle QPR$   
     (v) No    (vi) Yes. AA,  $\triangle DEF \sim \triangle PQR$
2.  $55^\circ, 55^\circ, 55^\circ$
14. Produce AD to a point E such that AD = DE and produce PM to a point N such that PM = MN. Join EC and NR.
15. 42m

## EXERCISE 6.4

1. 11.2 cm                      2. 4 : 1                      5. 1 : 4                      8. C                      9. D

## EXERCISE 6.5

1. (i) Yes, 25 cm                      (ii) No                      (iii) No                      (iv) Yes, 13 cm
6.  $a\sqrt{3}$                       9. 6m                      10.  $6\sqrt{7}$  m                      11.  $300\sqrt{61}$  km
12. 13m                      17. C

## EXERCISE 6.6 (Optional)\*

1. Through R, draw a line parallel to SP to intersect QP produced at T. Show PT = PR.
6. Use result (iii) of Q.5 of this Exercise.                      7. 3 m, 2.79 m

## EXERCISE 7.1

1. (i)  $2\sqrt{2}$                       (ii)  $4\sqrt{2}$                       (iii)  $2\sqrt{a^2 + b^2}$
2. 39; 39 km                      3. No                      4. Yes                      5. Champa is correct.
6. (i) Square                      (ii) No quadrilateral                      (iii) Parallelogram
7.  $(-7, 0)$                       8.  $-9, 3$                       9.  $\pm 4$ , QR =  $\sqrt{41}$ , PR =  $\sqrt{82}$ ,  $9\sqrt{2}$
10.  $3x + y - 5 = 0$

## EXERCISE 7.2

1. (1, 3)                      2.  $\left(2, -\frac{5}{3}\right); \left(0, -\frac{7}{3}\right)$

3.  $\sqrt{61}$  m; 5th line at a distance of 22.5 m      4. 2 : 7
5.  $1 : 1; \left(-\frac{3}{2}, 0\right)$       6.  $x = 6, y = 3$       7.  $(3, -10)$
8.  $\left(-\frac{2}{7}, -\frac{20}{7}\right)$       9.  $\left(-1, \frac{7}{2}\right), (0, 5), \left(1, \frac{13}{2}\right)$       10. 24 sq. units

### EXERCISE 7.3

1. (i)  $\frac{21}{2}$  sq. units      (ii) 32 sq. units      2. (i)  $k = 4$       (ii)  $k = 3$
3. 1 sq. unit; 1 : 4      4. 28 sq. units

### EXERCISE 7.4 (Optional)\*

1. 2 : 9      2.  $x + 3y - 7 = 0$       3.  $(3, -2)$       4.  $(1, 0), (1, 4)$
5. (i)  $(4, 6), (3, 2), (6, 5)$ ; taking AD and AB as coordinate axes  
 (ii)  $(12, 2), (13, 6), (10, 3)$ ; taking CB and CD as coordinate axes.  $\frac{9}{2}$  sq. units,  
 $\frac{9}{2}$  sq. units; areas are the same in both the cases.
6.  $\frac{15}{32}$  sq. units; 1 : 16
7. (i)  $D\left(\frac{7}{2}, \frac{9}{2}\right)$       (ii)  $P\left(\frac{11}{3}, \frac{11}{3}\right)$
- (iii)  $Q\left(\frac{11}{3}, \frac{11}{3}\right), R\left(\frac{11}{3}, \frac{11}{3}\right)$       (iv) P, Q, R are the same point.
- (v)  $\left(\frac{x_1 + x_2 + x_3}{3}, \frac{y_1 + y_2 + y_3}{3}\right)$       8. Rhombus

### EXERCISE 8.1

1. (i)  $\sin A = \frac{7}{25}, \cos A = \frac{24}{25}$       (ii)  $\sin C = \frac{24}{25}, \cos C = \frac{7}{25}$
2. 0      3.  $\cos A = \frac{\sqrt{7}}{4}, \tan A = \frac{3}{\sqrt{7}}$       4.  $\sin A = \frac{15}{17}, \sec A = \frac{17}{8}$

$$5. \sin \theta = \frac{5}{13}, \cos \theta = \frac{12}{13}, \tan \theta = \frac{5}{12}, \cot \theta = \frac{12}{5}, \operatorname{cosec} \theta = \frac{13}{5}$$

$$7. \text{ (i) } \frac{49}{64}$$

$$\text{ (ii) } \frac{49}{64}$$

8. Yes

$$9. \text{ (i) } 1 \quad \text{(ii) } 0$$

$$10. \sin P = \frac{12}{13}, \cos P = \frac{5}{13}, \tan P = \frac{12}{5}$$

$$11. \text{ (i) False} \quad \text{(ii) True} \quad \text{(iii) False} \quad \text{(iv) False} \quad \text{(v) False}$$

### EXERCISE 8.2

$$1. \text{ (i) } 1 \quad \text{(ii) } 2 \quad \text{(iii) } \frac{3\sqrt{2} - \sqrt{6}}{8} \quad \text{(iv) } \frac{43 - 24\sqrt{3}}{11} \quad \text{(v) } \frac{67}{12}$$

$$2. \text{ (i) } A \quad \text{(ii) } D \quad \text{(iii) } A \quad \text{(iv) } C \quad 3. \angle A = 45^\circ, \angle B = 15^\circ$$

$$4. \text{ (i) False} \quad \text{(ii) True} \quad \text{(iii) False} \quad \text{(iv) False} \quad \text{(v) True}$$

### EXERCISE 8.3

$$1. \text{ (i) } 1 \quad \text{(ii) } 1 \quad \text{(iii) } 0 \quad \text{(iv) } 0$$

$$3. \angle A = 36^\circ \quad 5. \angle A = 22^\circ \quad 7. \cos 23^\circ + \sin 15^\circ$$

### EXERCISE 8.4

$$1. \sin A = \frac{1}{\sqrt{1 + \cot^2 A}}, \tan A = \frac{1}{\cot A}, \sec A = \frac{\sqrt{1 + \cot^2 A}}{\cot A}$$

$$2. \sin A = \frac{\sqrt{\sec^2 A - 1}}{\sec A}, \cos A = \frac{1}{\sec A}, \tan A = \sqrt{\sec^2 A - 1}$$

$$\cot A = \frac{1}{\sqrt{\sec^2 A - 1}}, \operatorname{cosec} A = \frac{\sec A}{\sqrt{\sec^2 A - 1}}$$

$$3. \text{ (i) } 1 \quad \text{(ii) } 1 \quad 4. \text{ (i) } B \quad \text{(ii) } C \quad \text{(iii) } D \quad \text{(iv) } D$$

### EXERCISE 9.1

$$1. 10 \text{ m} \quad 2. 8\sqrt{3} \text{ m} \quad 3. 3 \text{ m}, 2\sqrt{3} \text{ m} \quad 4. 10\sqrt{3} \text{ m}$$

5.  $40\sqrt{3}$  m      6.  $19\sqrt{3}$  m      7.  $20(\sqrt{3} - 1)$  m      8.  $0.8(\sqrt{3} + 1)$  m  
 9.  $16\frac{2}{3}$  m      10.  $20\sqrt{3}$  m, 20 m, 60 m      11.  $10\sqrt{3}$  m, 10 m      12.  $7(\sqrt{3} + 1)$  m  
 13.  $75(\sqrt{3} - 1)$  m      14.  $58\sqrt{3}$  m      15. 3 seconds

**EXERCISE 10.1**

1. Infinitely many  
 2. (i) One      (ii) Secant      (iii) Two      (iv) Point of contact      3. D

**EXERCISE 10.2**

1. A      2. B      3. A      6. 3 cm  
 7. 8 cm      12.  $AB = 15$  cm,  $AC = 13$  cm

**EXERCISE 12.1**

1. 28 cm      2. 10 cm  
 3. Gold :  $346.5$  cm<sup>2</sup>; Red :  $1039.5$  cm<sup>2</sup>; Blue :  $1732.5$  cm<sup>2</sup>; Black :  $2425.5$  cm<sup>2</sup>; White :  $3118.5$  cm<sup>2</sup>.  
 4. 4375      5. A

**EXERCISE 12.2**

1.  $\frac{132}{7}$  cm<sup>2</sup>      2.  $\frac{77}{8}$  cm<sup>2</sup>      3.  $\frac{154}{3}$  cm<sup>2</sup>  
 4. (i)  $28.5$  cm<sup>2</sup>      (ii)  $235.5$  cm<sup>2</sup>  
 5. (i) 22 cm      (ii) 231 cm<sup>2</sup>      (iii)  $\left(231 - \frac{441\sqrt{3}}{4}\right)$  cm<sup>2</sup>  
 6.  $20.4375$  cm<sup>2</sup>;  $686.0625$  cm<sup>2</sup>      7.  $88.44$  cm<sup>2</sup>  
 8. (i)  $19.625$  m<sup>2</sup>      (ii)  $58.875$  cm<sup>2</sup>      9. (i) 285 mm      (ii)  $\frac{385}{4}$  mm<sup>2</sup>  
 10.  $\frac{22275}{28}$  cm<sup>2</sup>      11.  $\frac{158125}{126}$  cm<sup>2</sup>      12.  $189.97$  km<sup>2</sup>  
 13. ₹ 162.68      14. D

**EXERCISE 12.3**

1.  $\frac{4523}{28} \text{ cm}^2$
2.  $\frac{154}{3} \text{ cm}^2$
3.  $42 \text{ cm}^2$
4.  $\left(\frac{660}{7} + 36\sqrt{3}\right) \text{ cm}^2$
5.  $\frac{68}{7} \text{ cm}^2$
6.  $\left(\frac{22528}{7} - 768\sqrt{3}\right) \text{ cm}^2$
7.  $42 \text{ cm}^2$
8. (i)  $\frac{2804}{7} \text{ m}$  (ii)  $4320 \text{ m}^2$
9.  $66.5 \text{ cm}^2$
10.  $1620.5 \text{ cm}^2$
11.  $378 \text{ cm}^2$
12. (i)  $\frac{77}{8} \text{ cm}^2$  (ii)  $\frac{49}{8} \text{ cm}^2$
13.  $228 \text{ cm}^2$
14.  $\frac{308}{3} \text{ cm}^2$
15.  $98 \text{ cm}^2$
16.  $\frac{256}{7} \text{ cm}^2$

**EXERCISE 13.1**

1.  $160 \text{ cm}^2$
2.  $572 \text{ cm}^2$
3.  $214.5 \text{ cm}^2$
4. Greatest diameter = 7 cm, surface area =  $332.5 \text{ cm}^2$
5.  $\frac{1}{4}l^2(\pi + 24)$
6.  $220 \text{ mm}^2$
7.  $44 \text{ m}^2$ , ₹ 22000
8.  $18 \text{ cm}^2$
9.  $374 \text{ cm}^2$

**EXERCISE 13.2**

1.  $\pi \text{ cm}^3$
2.  $66 \text{ cm}^3$ . Volume of the air inside the model = Volume of air inside (cone + cylinder + cone)  
 $= \left(\frac{1}{3}\pi r^2 h_1 + \pi r^2 h_2 + \frac{1}{3}\pi r^2 h_1\right)$ , where  $r$  is the radius of the cone and the cylinder,  $h_1$  is the height (length) of the cone and  $h_2$  is the height (length) of the cylinder.

$$\text{Required Volume} = \frac{1}{3}\pi r^2 (h_1 + 3h_2 + h_1).$$

3.  $338 \text{ cm}^3$
4.  $523.53 \text{ cm}^3$
5. 100
6.  $892.26 \text{ kg}$
7.  $1.131 \text{ m}^3$  (approx.)
8. Not correct. Correct answer is  $346.51 \text{ cm}^3$ .

**EXERCISE 13.3**

- |                            |   |                |
|----------------------------|---|----------------|
| 1. 2.74 cm                 | 2. 12 cm                                    | 3. 2.5 m       |
| 4. 1.125 m                 | 5. 10                                       | 6. 400         |
| 7. 36 cm; $12\sqrt{13}$ cm | 8. 562500 m <sup>2</sup> or 56.25 hectares. | 9. 100 minutes |

**EXERCISE 13.4**

- |   |                       |                                     |
|---|-----------------------|-------------------------------------|
| 1. $102\frac{2}{3}$ cm <sup>3</sup>                           | 2. 48 cm <sup>2</sup> | 3. $710\frac{2}{7}$ cm <sup>2</sup> |
| 4. Cost of milk is ₹ 209 and cost of metal sheet is ₹ 156.75. | 5. 7964.4 m           |                                     |

**EXERCISE 13.5 (Optional)\***

- |                           |  |
|---------------------------|--|
| 1. 1256 cm; 788g (approx) | 2. 30.14 cm <sup>3</sup> ; 52.75 cm <sup>2</sup> |
| 3. 1792                   | 5. $782\frac{4}{7}$ cm <sup>2</sup>              |

**EXERCISE 14.1**

- |  |              |
|--|--------------|
| 1. 8.1 plants. We have used direct method because numerical values of $x_i$ and $f_i$ are small. |              |
| 2. ₹ 545.20  | 3. $f=20$    |
| 5. 57.19   | 4. 75.9      |
| 8. 12.48 days  | 6. ₹ 211     |
|  | 7. 0.099 ppm |
|  | 9. 69.43 %   |

**EXERCISE 14.2**

- Mode = 36.8 years, Mean = 35.37 years. Maximum number of patients admitted in the hospital are of the age 36.8 years (approx.), while on an average the age of a patient admitted to the hospital is 35.37 years.
- 65.625 hours
- Modal monthly expenditure = ₹ 1847.83, Mean monthly expenditure = ₹ 2662.5.
- Mode : 30.6, Mean = 29.2. Most states/U.T. have a student teacher ratio of 30.6 and on an average, this ratio is 29.2.
- Mode = 4608.7 runs
- Mode = 44.7 cars

**EXERCISE 14.3**

- Median = 137 units, Mean = 137.05 units, Mode = 135.76 units.  
The three measures are approximately the same in this case.

2.  $x = 8, y = 7$
3. Median age = 35.76 years
4. Median length = 146.75 mm
5. Median life = 3406.98 hours
6. Median = 8.05, Mean = 8.32, Modal size = 7.88
7. Median weight = 56.67 kg

### EXERCISE 14.4

1.

Daily income (in ₹)	Cumulative frequency
Less than 120	12
Less than 140	26
Less than 160	34
Less than 180	40
Less than 200	50

Draw ogive by plotting the points :  
 (120, 12), (140, 26), (160, 34),  
 (180, 40) and (200, 50)

2. Draw the ogive by plotting the points : (38, 0), (40, 3), (42, 5), (44, 9), (46, 14), (48, 28), (50, 32) and (52, 35). Here  $\frac{n}{2} = 17.5$ . Locate the point on the ogive whose ordinate is 17.5. The x-coordinate of this point will be the median.

3.

Production yield (kg/ha)	Cumulative frequency
More than or equal to 50	100
More than or equal to 55	98
More than or equal to 60	90
More than or equal to 65	78
More than or equal to 70	54
More than or equal to 75	16

Now, draw the ogive by plotting the points : (50, 100), (55, 98), (60, 90), (65, 78), (70, 54) and (75, 16).

## EXERCISE 15.1

1. (i) 1 (ii) 0, impossible event (iii) 1, sure or certain event  
 (iv) 1 (v) 0, 1
2. The experiments (iii) and (iv) have equally likely outcomes.
3. When we toss a coin, the outcomes head and tail are equally likely. So, the result of an individual coin toss is completely unpredictable.
4. B 5. 0.95 6. (i) 0 (ii) 1
7. 0.008 8. (i)  $\frac{3}{8}$  (ii)  $\frac{5}{8}$
9. (i)  $\frac{5}{17}$  (ii)  $\frac{8}{17}$  (iii)  $\frac{13}{17}$  10. (i)  $\frac{5}{9}$  (ii)  $\frac{17}{18}$
11.  $\frac{5}{13}$  12. (i)  $\frac{1}{8}$  (ii)  $\frac{1}{2}$  (iii)  $\frac{3}{4}$  (iv) 1
13. (i)  $\frac{1}{2}$  (ii)  $\frac{1}{2}$  (iii)  $\frac{1}{2}$
14. (i)  $\frac{1}{26}$  (ii)  $\frac{3}{13}$  (iii)  $\frac{3}{26}$  (iv)  $\frac{1}{52}$  (v)  $\frac{1}{4}$  (vi)  $\frac{1}{52}$
15. (i)  $\frac{1}{5}$  (ii) (a)  $\frac{1}{4}$  (b) 0 16.  $\frac{11}{12}$
17. (i)  $\frac{1}{5}$  (ii)  $\frac{15}{19}$  18. (i)  $\frac{9}{10}$  (ii)  $\frac{1}{10}$  (iii)  $\frac{1}{5}$
19. (i)  $\frac{1}{3}$  (ii)  $\frac{1}{6}$  20.  $\frac{\pi}{24}$  21. (i)  $\frac{31}{36}$  (ii)  $\frac{5}{36}$
22. (i)

Sum on 2 dice	2	3	4	5	6	7	8	9	10	11	12
Probability	$\frac{1}{36}$	$\frac{2}{36}$	$\frac{3}{36}$	$\frac{4}{36}$	$\frac{5}{36}$	$\frac{6}{36}$	$\frac{5}{36}$	$\frac{4}{36}$	$\frac{3}{36}$	$\frac{2}{36}$	$\frac{1}{36}$

- (ii) No. The eleven sums are not equally likely.

23.  $\frac{3}{4}$ ; Possible outcomes are : HHH, TTT, HHT, HTH, HTT, THH, THT, TTH. Here, THH means tail in the first toss, head on the second toss and head on the third toss and so on.
24. (i)  $\frac{25}{36}$       (ii)  $\frac{11}{36}$
25. (i) Incorrect. We can classify the outcomes like this but they are not then 'equally likely'. Reason is that 'one of each' can result in two ways — from a head on first coin and tail on the second coin or from a tail on the first coin and head on the second coin. This makes it twice as likely as two heads (or two tails).
- (ii) Correct. The two outcomes considered in the question are equally likely.

### EXERCISE 15.2 (Optional)\*

1. (i)  $\frac{1}{5}$       (ii)  $\frac{8}{25}$       (iii)  $\frac{4}{5}$

2.

	1	2	2	3	3	6
1	2	3	3	4	4	7
2	3	4	4	5	5	8
2	3	4	4	5	5	8
3	4	5	5	6	6	9
3	4	5	5	6	6	9
6	7	8	8	9	9	12

- (i)  $\frac{1}{2}$       (ii)  $\frac{1}{9}$       (iii)  $\frac{5}{12}$
3. 10      4.  $\frac{x}{12}, x = 3$       5. 8

### EXERCISE A1.1

1. (i) Ambiguous      (ii) True      (iii) True      (iv) Ambiguous  
 (v) Ambiguous

2. (i) True      (ii) True      (iii) False      (iv) True      (v) True
3. Only (ii) is true.
4. (i) If  $a > 0$  and  $a^2 > b^2$ , then  $a > b$ .  
 (ii) If  $xy \geq 0$  and  $x^2 = y^2$ , then  $x = y$ .  
 (iii) If  $(x + y)^2 = x^2 + y^2$  and  $y \neq 0$ , then  $x = 0$ .  
 (iv) The diagonals of a parallelogram bisect each other.

**EXERCISE A1.2**

1. A is mortal      2.  $ab$  is rational
3. Decimal expansion of  $\sqrt{17}$  is non-terminating non-recurring.
4.  $y = 7$       5.  $\angle A = 100^\circ$ ,  $\angle C = 100^\circ$ ,  $\angle D = 180^\circ$
6. PQRS is a rectangle.
7. Yes, because of the premise. No, because  $\sqrt{3721} = 61$  which is not irrational. Since the premise was wrong, the conclusion is false.

**EXERCISE A1.3**

1. Take two consecutive odd numbers as  $2n + 1$  and  $2n + 3$  for some integer  $n$ .

**EXERCISE A1.4**

1. (i) Man is not mortal.  
 (ii) Line  $l$  is not parallel to line  $m$ .  
 (iii) The chapter does not have many exercises.  
 (iv) Not all integers are rational numbers.  
 (v) All prime numbers are not odd.  
 (vi) Some students are lazy.  
 (vii) All cats are black.  
 (viii) There is at least one real number  $x$ , such that  $\sqrt{x} = -1$ .  
 (ix) 2 does not divide the positive integer  $a$ .  
 (x) Integers  $a$  and  $b$  are not coprime.
2. (i) Yes      (ii) No      (iii) No      (iv) No      (v) Yes

**EXERCISE A1.5**

1. (i) If Sharan sweats a lot, then it is hot in Tokyo.  
(ii) If Shalini's stomach grumbles, then she is hungry.  
(iii) If Jaswant can get a degree, then she has a scholarship.  
(iv) If a plant is alive, then it has flowers.  
(v) If an animal has a tail, then it is a cat.
2. (i) If the base angles of triangle ABC are equal, then it is isosceles. True.  
(ii) If the square of an integer is odd, then the integer is odd. True.  
(iii) If  $x = 1$ , then  $x^2 = 1$ . True.  
(iv) If AC and BD bisect each other, then ABCD is a parallelogram. True.  
(v) If  $a + (b + c) = (a + b) + c$ , then  $a$ ,  $b$  and  $c$  are whole numbers. False.  
(vi) If  $x + y$  is an even number, then  $x$  and  $y$  are odd. False.  
(vii) If a parallelogram is a rectangle, its vertices lie on a circle. True.

**EXERCISE A1.6**

1. Suppose to the contrary  $b \leq d$ .
3. See Example 10 of Chapter 1.
6. See Theorem 5.1 of Class IX Mathematics Textbook.

**EXERCISE A2.2**

1. (i)  $\frac{1}{5}$  (ii) 160
2. Take  $1 \text{ cm}^2$  area and count the number of dots in it. Total number of trees will be the product of this number and the area (in  $\text{cm}^2$ ).
3. Rate of interest in instalment scheme is 17.74 %, which is less than 18 %.

**EXERCISE A2.3**

1. Students find their own answers.

# PROOFS IN MATHEMATICS

# A1

## A1.1 Introduction

The ability to reason and think clearly is extremely useful in our daily life. For example, suppose a politician tells you, ‘If you are interested in a clean government, then you should vote for me.’ What he actually wants you to believe is that if you do not vote for him, then you may not get a clean government. Similarly, if an advertisement tells you, ‘The intelligent wear XYZ shoes’, what the company wants you to conclude is that if you do not wear XYZ shoes, then you are not intelligent enough. You can yourself observe that both the above statements may mislead the general public. So, if we understand the process of reasoning correctly, we do not fall into such traps unknowingly.

The correct use of reasoning is at the core of mathematics, especially in constructing proofs. In Class IX, you were introduced to the idea of proofs, and you actually proved many statements, especially in geometry. Recall that a proof is made up of several mathematical statements, each of which is logically deduced from a previous statement in the proof, or from a theorem proved earlier, or an axiom, or the hypotheses. The main tool, we use in constructing a proof, is the process of deductive reasoning.

We start the study of this chapter with a review of what a mathematical statement is. Then, we proceed to sharpen our skills in deductive reasoning using several examples. We shall also deal with the concept of negation and finding the negation of a given statement. Then, we discuss what it means to find the converse of a given statement. Finally, we review the ingredients of a proof learnt in Class IX by analysing the proofs of several theorems. Here, we also discuss the idea of proof by contradiction, which you have come across in Class IX and many other chapters of this book.

## A1.2 Mathematical Statements Revisited

Recall, that a ‘statement’ is a meaningful sentence which is not an order, or an exclamation or a question. For example, ‘Which two teams are playing in the

Cricket World Cup Final?’ is a question, not a statement. ‘Go and finish your homework’ is an order, not a statement. ‘What a fantastic goal!’ is an exclamation, not a statement.

Remember, in general, statements can be one of the following:

- *always true*
- *always false*
- *ambiguous*

In Class IX, you have also studied that in mathematics, **a statement is acceptable only if it is either always true or always false**. So, ambiguous sentences are not considered as mathematical statements.

Let us review our understanding with a few examples.

**Example 1 :** State whether the following statements are always true, always false or ambiguous. Justify your answers.

- The Sun orbits the Earth.
- Vehicles have four wheels.
- The speed of light is approximately  $3 \times 10^5$  km/s.
- A road to Kolkata will be closed from November to March.
- All humans are mortal.

**Solution :**

- This statement is always false, since astronomers have established that the Earth orbits the Sun.
- This statement is ambiguous, because we cannot decide if it is always true or always false. This depends on what the vehicle is — vehicles can have 2, 3, 4, 6, 10, etc., wheels.
- This statement is always true, as verified by physicists.
- This statement is ambiguous, because it is not clear which road is being referred to.
- This statement is always true, since every human being has to die some time.

**Example 2 :** State whether the following statements are true or false, and justify your answers.

- All equilateral triangles are isosceles.
- Some isosceles triangles are equilateral.
- All isosceles triangles are equilateral.
- Some rational numbers are integers.

- (v) Some rational numbers are not integers.
- (vi) Not all integers are rational.
- (vii) Between any two rational numbers there is no rational number.

**Solution :**

- (i) This statement is true, because equilateral triangles have equal sides, and therefore are isosceles.
- (ii) This statement is true, because those isosceles triangles whose base angles are  $60^\circ$  are equilateral.
- (iii) This statement is false. Give a counter-example for it.
- (iv) This statement is true, since rational numbers of the form  $\frac{p}{q}$ , where  $p$  is an integer and  $q = 1$ , are integers (for example,  $3 = \frac{3}{1}$ ).
- (v) This statement is true, because rational numbers of the form  $\frac{p}{q}$ ,  $p, q$  are integers and  $q$  does not divide  $p$ , are not integers (for example,  $\frac{3}{2}$ ).
- (vi) This statement is the same as saying 'there is an integer which is not a rational number'. This is false, because all integers are rational numbers.
- (vii) This statement is false. As you know, between any two rational numbers  $r$  and  $s$  lies  $\frac{r+s}{2}$ , which is a rational number.

**Example 3 :** If  $x < 4$ , which of the following statements are true? Justify your answers.

- (i)  $2x > 8$
- (ii)  $2x < 6$
- (iii)  $2x < 8$

**Solution :**

- (i) This statement is false, because, for example,  $x = 3 < 4$  does not satisfy  $2x > 8$ .
- (ii) This statement is false, because, for example,  $x = 3.5 < 4$  does not satisfy  $2x < 6$ .
- (iii) This statement is true, because it is the same as  $x < 4$ .

**Example 4 :** Restate the following statements with appropriate conditions, so that they become true statements:

- (i) If the diagonals of a quadrilateral are equal, then it is a rectangle.
- (ii) A line joining two points on two sides of a triangle is parallel to the third side.
- (iii)  $\sqrt{p}$  is irrational for all positive integers  $p$ .
- (iv) All quadratic equations have two real roots.

**Solution :**

- (i) If the diagonals of a parallelogram are equal, then it is a rectangle.
- (ii) A line joining the mid-points of two sides of a triangle is parallel to the third side.
- (iii)  $\sqrt{p}$  is irrational for all primes  $p$ .
- (iv) All quadratic equations have at most two real roots.

**Remark :** There can be other ways of restating the statements above. For instance, (iii) can also be restated as ‘ $\sqrt{p}$  is irrational for all positive integers  $p$  which are not a perfect square’.

**EXERCISE A1.1**

1. State whether the following statements are always true, always false or ambiguous. Justify your answers.
  - (i) All mathematics textbooks are interesting.
  - (ii) The distance from the Earth to the Sun is approximately  $1.5 \times 10^8$  km.
  - (iii) All human beings grow old.
  - (iv) The journey from Uttarkashi to Harsil is tiring.
  - (v) The woman saw an elephant through a pair of binoculars.
2. State whether the following statements are true or false. Justify your answers.
  - (i) All hexagons are polygons.
  - (ii) Some polygons are pentagons.
  - (iii) Not all even numbers are divisible by 2.
  - (iv) Some real numbers are irrational.
  - (v) Not all real numbers are rational.
3. Let  $a$  and  $b$  be real numbers such that  $ab \neq 0$ . Then which of the following statements are true? Justify your answers.
  - (i) Both  $a$  and  $b$  must be zero.
  - (ii) Both  $a$  and  $b$  must be non-zero.
  - (iii) Either  $a$  or  $b$  must be non-zero.
4. Restate the following statements with appropriate conditions, so that they become true.
  - (i) If  $a^2 > b^2$ , then  $a > b$ .
  - (ii) If  $x^2 = y^2$ , then  $x = y$ .
  - (iii) If  $(x + y)^2 = x^2 + y^2$ , then  $x = 0$ .
  - (iv) The diagonals of a quadrilateral bisect each other.

**A1.3 Deductive Reasoning**

In Class IX, you were introduced to the idea of deductive reasoning. Here, we will work with many more examples which will illustrate how **deductive reasoning** is

used to **deduce** conclusions from given statements that we assume to be true. The given statements are called ‘premises’ or ‘hypotheses’. We begin with some examples.

**Example 5 :** Given that Bijapur is in the state of Karnataka, and suppose Shabana lives in Bijapur. In which state does Shabana live?

**Solution :** Here we have two premises:

- (i) Bijapur is in the state of Karnataka                      (ii) Shabana lives in Bijapur

From these premises, we deduce that Shabana lives in the state of Karnataka.

**Example 6 :** Given that all mathematics textbooks are interesting, and suppose you are reading a mathematics textbook. What can we conclude about the textbook you are reading?

**Solution :** Using the two premises (or hypotheses), we can deduce that you are reading an interesting textbook.

**Example 7 :** Given that  $y = -6x + 5$ , and suppose  $x = 3$ . What is  $y$ ?

**Solution :** Given the two hypotheses, we get  $y = -6(3) + 5 = -13$ .

**Example 8 :** Given that ABCD is a parallelogram, and suppose  $AD = 5$  cm,  $AB = 7$  cm (see Fig. A1.1). What can you conclude about the lengths of DC and BC?



**Fig. A1.1**

**Solution :** We are given that ABCD is a parallelogram. So, we deduce that all the properties that hold for a parallelogram hold for ABCD. Therefore, in particular, the property that ‘the opposite sides of a parallelogram are equal to each other’, holds. Since we know  $AD = 5$  cm, we can deduce that  $BC = 5$  cm. Similarly, we deduce that  $DC = 7$  cm.

**Remark :** In this example, we have seen how we will often need to find out and use properties hidden in a given premise.

**Example 9 :** Given that  $\sqrt{p}$  is irrational for all primes  $p$ , and suppose that 19423 is a prime. What can you conclude about  $\sqrt{19423}$ ?

**Solution :** We can conclude that  $\sqrt{19423}$  is irrational.

In the examples above, you might have noticed that we do not know whether the hypotheses are true or not. We are **assuming** that they are true, and then applying deductive reasoning. For instance, in Example 9, we haven’t checked whether 19423

is a prime or not; we assume it to be a prime for the sake of our argument. What we are trying to emphasise in this section is that given a particular statement, how we use deductive reasoning to arrive at a conclusion. What really matters here is that we use the correct process of reasoning, and this process of reasoning does not depend on the trueness or falsity of the hypotheses. However, it must also be noted that if we start with an incorrect premise (or hypothesis), we may arrive at a wrong conclusion.

### EXERCISE A1.2

1. Given that all women are mortal, and suppose that A is a woman, what can we conclude about A?
2. Given that the product of two rational numbers is rational, and suppose  $a$  and  $b$  are rationals, what can you conclude about  $ab$ ?
3. Given that the decimal expansion of irrational numbers is non-terminating, non-recurring, and  $\sqrt{17}$  is irrational, what can we conclude about the decimal expansion of  $\sqrt{17}$ ?
4. Given that  $y = x^2 + 6$  and  $x = -1$ , what can we conclude about the value of  $y$ ?
5. Given that ABCD is a parallelogram and  $\angle B = 80^\circ$ . What can you conclude about the other angles of the parallelogram?
6. Given that PQRS is a cyclic quadrilateral and also its diagonals bisect each other. What can you conclude about the quadrilateral?
7. Given that  $\sqrt{p}$  is irrational for all primes  $p$  and also suppose that 3721 is a prime. Can you conclude that  $\sqrt{3721}$  is an irrational number? Is your conclusion correct? Why or why not?

### A1.4 Conjectures, Theorems, Proofs and Mathematical Reasoning

Consider the Fig. A1.2. The first circle has one point on it, the second two points, the third three, and so on. All possible lines connecting the points are drawn in each case.

The lines divide the circle into mutually exclusive regions (having no common portion). We can count these and tabulate our results as shown :

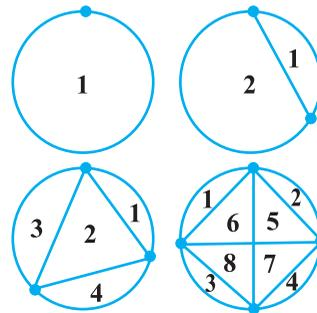


Fig. A1.2

Number of points	Number of regions
1	1
2	2
3	4
4	8
5	
6	
7	

Some of you might have come up with a formula predicting the number of regions given the number of points. From Class IX, you may remember that this intelligent guess is called a *'conjecture'*.

Suppose your conjecture is that given ' $n$ ' points on a circle, there are  $2^{n-1}$  mutually exclusive regions, created by joining the points with all possible lines. This seems an extremely sensible guess, and one can check that if  $n = 5$ , we do get 16 regions. So, having verified this formula for 5 points, are you satisfied that for any  $n$  points there are  $2^{n-1}$  regions? If so, how would you respond, if someone asked you, how you can be sure about this for  $n = 25$ , say? To deal with such questions, you would need a proof which shows beyond doubt that this result is true, or a counter-example to show that this result fails for some ' $n$ '. Actually, if you are patient and try it out for  $n = 6$ , you will find that there are 31 regions, and for  $n = 7$  there are 57 regions. So,  $n = 6$ , is a counter-example to the conjecture above. This demonstrates the power of a counter-example. You may recall that in the Class IX we discussed that to **disprove a statement, it is enough to come up with a single counter-example**.

You may have noticed that we insisted on a proof regarding the number of regions in spite of verifying the result for  $n = 1, 2, 3, 4$  and  $5$ . Let us consider a few more examples. You are familiar with the following result (given in Chapter 5):

$$1 + 2 + 3 + \dots + n = \frac{n(n+1)}{2}.$$

To establish its validity, it is not enough to verify the result for  $n = 1, 2, 3$ , and so on, because there may be some ' $n$ ' for which this result is not true (just as in the example above, the result failed for  $n = 6$ ). What we need is a proof which establishes its truth beyond doubt. You shall learn a proof for the same in higher classes.

Now, consider Fig. A1.3, where PQ and PR are tangents to the circle drawn from P.

You have proved that  $PQ = PR$  (Theorem 10.2). You were not satisfied by only drawing several such figures, measuring the lengths of the respective tangents, and verifying for yourselves that the result was true in each case.

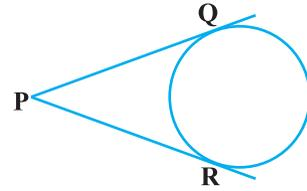


Fig. A1.3

Do you remember what did the proof consist of? It consisted of a sequence of statements (called **valid arguments**), each following from the earlier statements in the proof, or from previously proved (and known) results independent from the result to be proved, or from axioms, or from definitions, or from the assumptions you had made. And you concluded your proof with the statement  $PQ = PR$ , i.e., the statement you wanted to prove. This is the way any proof is constructed.

We shall now look at some examples and theorems and analyse their proofs to help us in getting a better understanding of how they are constructed.

We begin by using the so-called ‘direct’ or ‘deductive’ method of proof. In this method, we make several statements. Each is **based on previous statements**. If each statement is logically correct (i.e., a valid argument), it leads to a logically correct conclusion.

**Example 10 :** The sum of two rational numbers is a rational number.

**Solution :**

S.No.	Statements	Analysis/Comments
1.	Let $x$ and $y$ be rational numbers.	Since the result is about rationals, we start with $x$ and $y$ which are rational.
2.	Let $x = \frac{m}{n}$ , $n \neq 0$ and $y = \frac{p}{q}$ , $q \neq 0$ where $m$ , $n$ , $p$ and $q$ are integers.	Apply the definition of rationals.
3.	So, $x + y = \frac{m}{n} + \frac{p}{q} = \frac{mq + np}{nq}$	The result talks about the sum of rationals, so we look at $x + y$ .

4.	Using the properties of integers, we see that $mq + np$ and $nq$ are integers.	Using known properties of integers.
5.	Since $n \neq 0$ and $q \neq 0$ , it follows that $nq \neq 0$ .	Using known properties of integers.
6.	Therefore, $x + y = \frac{mq + np}{nq}$ is a rational number	Using the definition of a rational number.

**Remark :** Note that, each statement in the proof above is based on a previously established fact, or definition.

**Example 11 :** Every prime number greater than 3 is of the form  $6k + 1$  or  $6k + 5$ , where  $k$  is some integer.

**Solution :**

S.No.	Statements	Analysis/Comments
1.	Let $p$ be a prime number greater than 3.	Since the result has to do with a prime number greater than 3, we start with such a number.
2.	Dividing $p$ by 6, we find that $p$ can be of the form $6k, 6k + 1, 6k + 2, 6k + 3, 6k + 4$ , or $6k + 5$ , where $k$ is an integer.	Using Euclid's division lemma.
3.	But $6k = 2(3k)$ , $6k + 2 = 2(3k + 1)$ , $6k + 4 = 2(3k + 2)$ , and $6k + 3 = 3(2k + 1)$ . So, they are not primes.	We now analyse the remainders given that $p$ is prime.
4.	So, $p$ is forced to be of the form $6k + 1$ or $6k + 5$ , for some integer $k$ .	We arrive at this conclusion having eliminated the other options.

**Remark :** In the above example, we have arrived at the conclusion by eliminating different options. This method is sometimes referred to as the **Proof by Exhaustion**.

**Theorem A1.1 (Converse of the Pythagoras Theorem) :** *If in a triangle the square of the length of one side is equal to the sum of the squares of the other two sides, then the angle opposite the first side is a right angle.*

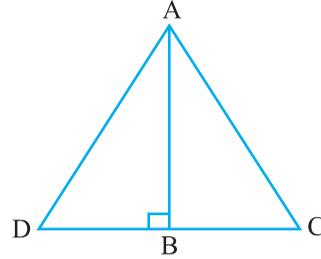


Fig. A1.4

**Proof :**

S.No.	Statements	Analysis
1.	Let $\triangle ABC$ satisfy the hypothesis $AC^2 = AB^2 + BC^2$ .	Since we are proving a statement about such a triangle, we begin by taking this.
2.	Construct line $BD$ perpendicular to $AC$ , such that $BD = BC$ , and join $A$ to $D$ .	This is the intuitive step we have talked about that we often need to take for proving theorems.
3.	By construction, $\triangle ABD$ is a right triangle, and from the Pythagoras Theorem, we have $AD^2 = AB^2 + BD^2$ .	We use the Pythagoras theorem, which is already proved.
4.	By construction, $BD = BC$ . Therefore, we have $AD^2 = AB^2 + BC^2$ .	Logical deduction.
5.	Therefore, $AC^2 = AB^2 + BC^2 = AD^2$ .	Using assumption, and previous statement.
6.	Since $AC$ and $AD$ are positive, we have $AC = AD$ .	Using known property of numbers.
7.	We have just shown $AC = AD$ . Also $BC = BD$ by construction, and $AB$ is common. Therefore, by SSS, $\triangle ABC \cong \triangle ABD$ .	Using known theorem.
8.	Since $\triangle ABC \cong \triangle ABD$ , we get $\angle ABC = \angle ABD$ , which is a right angle.	Logical deduction, based on previously established fact.

**Remark :** Each of the results above has been proved by a sequence of steps, all linked together. Their order is important. Each step in the proof follows from previous steps and earlier known results. (Also see Theorem 6.9.)

### EXERCISE A1.3

In each of the following questions, we ask you to prove a statement. List all the steps in each proof, and give the reason for each step.

1. Prove that the sum of two consecutive odd numbers is divisible by 4.
2. Take two consecutive odd numbers. Find the sum of their squares, and then add 6 to the result. Prove that the new number is always divisible by 8.
3. If  $p \geq 5$  is a prime number, show that  $p^2 + 2$  is divisible by 3.  
[Hint: Use Example 11].
4. Let  $x$  and  $y$  be rational numbers. Show that  $xy$  is a rational number.
5. If  $a$  and  $b$  are positive integers, then you know that  $a = bq + r$ ,  $0 \leq r < b$ , where  $q$  is a whole number. Prove that  $\text{HCF}(a, b) = \text{HCF}(b, r)$ .  
[Hint : Let  $\text{HCF}(b, r) = h$ . So,  $b = k_1h$  and  $r = k_2h$ , where  $k_1$  and  $k_2$  are coprime.]
6. A line parallel to side BC of a triangle ABC, intersects AB and AC at D and E respectively.

Prove that  $\frac{AD}{DB} = \frac{AE}{EC}$ .

### A1.5 Negation of a Statement

In this section, we discuss what it means to ‘negate’ a statement. Before we start, we would like to introduce some notation, which will make it easy for us to understand these concepts. To start with, let us look at a statement as a single unit, and give it a name. For example, we can denote the statement ‘It rained in Delhi on 1 September 2005’ by  $p$ . We can also write this by

$p$ : It rained in Delhi on 1 September 2005.

Similarly, let us write

$q$ : All teachers are female.

$r$ : Mike’s dog has a black tail.

$s$ :  $2 + 2 = 4$ .

$t$ : Triangle ABC is equilateral.

This notation now helps us to discuss properties of statements, and also to see how we can combine them. In the beginning we will be working with what we call ‘simple’ statements, and will then move onto ‘compound’ statements.

Now consider the following table in which we make a new statement from each of the given statements.

Original statement	New statement
$p$ : It rained in Delhi on 1 September 2005	$\sim p$ : It is false that it rained in Delhi on 1 September 2005.
$q$ : All teachers are female.	$\sim q$ : It is false that all teachers are female.
$r$ : Mike's dog has a black tail.	$\sim r$ : It is false that Mike's dog has a black tail.
$s$ : $2 + 2 = 4$ .	$\sim s$ : It is false that $2 + 2 = 4$ .
$t$ : Triangle ABC is equilateral.	$\sim t$ : It is false that triangle ABC is equilateral.

Each new statement in the table is a *negation* of the corresponding old statement. That is,  $\sim p$ ,  $\sim q$ ,  $\sim r$ ,  $\sim s$  and  $\sim t$  are negations of the statements  $p$ ,  $q$ ,  $r$ ,  $s$  and  $t$ , respectively. Here,  $\sim p$  is read as 'not  $p$ '. The statement  $\sim p$  negates the assertion that the statement  $p$  makes. Notice that in our usual talk we would simply mean  $\sim p$  as 'It did not rain in Delhi on 1 September 2005.' However, we need to be careful while doing so. You might think that one can obtain the negation of a statement by simply inserting the word 'not' in the given statement at a suitable place. While this works in the case of  $p$ , the difficulty comes when we have a statement that begins with 'all'. Consider, for example, the statement  $q$ : All teachers are female. We said the negation of this statement is  $\sim q$ : It is false that all teachers are female. This is the same as the statement 'There are some teachers who are males.' Now let us see what happens if we simply insert 'not' in  $q$ . We obtain the statement: 'All teachers are not female', or we can obtain the statement: 'Not all teachers are female.' The first statement can confuse people. It could imply (if we lay emphasis on the word 'All') that all teachers are male! This is certainly not the negation of  $q$ . However, the second statement gives the meaning of  $\sim q$ , i.e., that there is at least one teacher who is not a female. So, be careful when writing the negation of a statement!

So, how do we decide that we have the correct negation? We use the following criterion.

*Let  $p$  be a statement and  $\sim p$  its negation. Then  $\sim p$  is false whenever  $p$  is true, and  $\sim p$  is true whenever  $p$  is false.*

For example, if it is true that Mike's dog has a black tail, then it is false that Mike's dog does not have a black tail. If it is false that 'Mike's dog has a black tail', then it is true that 'Mike's dog does not have a black tail'.

Similarly, the negations for the statements  $s$  and  $t$  are:

$s$ :  $2 + 2 = 4$ ; negation,  $\sim s$ :  $2 + 2 \neq 4$ .

$t$ : Triangle ABC is equilateral; negation,  $\sim t$ : Triangle ABC is not equilateral.

Now, what is  $\sim(\sim s)$ ? It would be  $2 + 2 = 4$ , which is  $s$ . And what is  $\sim(\sim t)$ ? This would be 'the triangle ABC is equilateral', i.e.,  $t$ . In fact, **for any statement  $p$ ,  $\sim(\sim p)$  is  $p$ .**

**Example 12 :** State the negations for the following statements:

- (i) Mike's dog does not have a black tail.
- (ii) All irrational numbers are real numbers.
- (iii)  $\sqrt{2}$  is irrational.
- (iv) Some rational numbers are integers.
- (v) Not all teachers are males.
- (vi) Some horses are not brown.
- (vii) There is no real number  $x$ , such that  $x^2 = -1$ .

**Solution :**

- (i) It is false that Mike's dog does not have a black tail, i.e., Mike's dog has a black tail.
- (ii) It is false that all irrational numbers are real numbers, i.e., some (at least one) irrational numbers are not real numbers. One can also write this as, 'Not all irrational numbers are real numbers.'
- (iii) It is false that  $\sqrt{2}$  is irrational, i.e.,  $\sqrt{2}$  is not irrational.
- (iv) It is false that some rational numbers are integers, i.e., no rational number is an integer.
- (v) It is false that not all teachers are males, i.e., all teachers are males.
- (vi) It is false that some horses are not brown, i.e., all horses are brown.
- (vii) It is false that there is no real number  $x$ , such that  $x^2 = -1$ , i.e., there is at least one real number  $x$ , such that  $x^2 = -1$ .

**Remark :** From the above discussion, you may arrive at the following **Working Rule** for obtaining the negation of a statement :

- (i) First write the statement with a 'not'.
- (ii) If there is any confusion, make suitable modification, specially in the statements involving 'All' or 'Some'.

### EXERCISE A1.4

- State the negations for the following statements :
  - Man is mortal.
  - Line  $l$  is parallel to line  $m$ .
  - This chapter has many exercises.
  - All integers are rational numbers.
  - Some prime numbers are odd.
  - No student is lazy.
  - Some cats are not black.
  - There is no real number  $x$ , such that  $\sqrt{x} = -1$ .
  - 2 divides the positive integer  $a$ .
  - Integers  $a$  and  $b$  are coprime.
- In each of the following questions, there are two statements. State if the second is the negation of the first or not.
  - Mumtaz is hungry.  
Mumtaz is not hungry.
  - Some cats are black.  
Some cats are brown.
  - All elephants are huge.  
One elephant is not huge.
  - All fire engines are red.  
All fire engines are not red.
  - No man is a cow.  
Some men are cows.

### A1.6 Converse of a Statement

We now investigate the notion of the converse of a statement. For this, we need the notion of a ‘compound’ statement, that is, a statement which is a combination of one or more ‘simple’ statements. There are many ways of creating compound statements, but we will focus on those that are created by connecting two simple statements with the use of the words ‘if’ and ‘then’. For example, the statement ‘If it is raining, then it is difficult to go on a bicycle’, is made up of two statements:

$p$ : It is raining

$q$ : It is difficult to go on a bicycle.

Using our previous notation we can say: If  $p$ , then  $q$ . We can also say ‘ $p$  implies  $q$ ’, and denote it by  $p \Rightarrow q$ .

Now, suppose you have the statement ‘If the water tank is black, then it contains potable water.’ This is of the form  $p \Rightarrow q$ , where the hypothesis is  $p$  (the water tank is black) and the conclusion is  $q$  (the tank contains potable water). Suppose we interchange the hypothesis and the conclusion, what do we get? We get  $q \Rightarrow p$ , i.e., if the water in the tank is potable, then the tank must be black. This statement is called the **converse** of the statement  $p \Rightarrow q$ .

In general, the **converse** of the statement  $p \Rightarrow q$  is  $q \Rightarrow p$ , where  $p$  and  $q$  are statements. Note that  $p \Rightarrow q$  and  $q \Rightarrow p$  are the converses of each other.

**Example 13 :** Write the converses of the following statements :

- (i) If Jamila is riding a bicycle, then 17 August falls on a Sunday.
- (ii) If 17 August is a Sunday, then Jamila is riding a bicycle.
- (iii) If Pauline is angry, then her face turns red.
- (iv) If a person has a degree in education, then she is allowed to teach.
- (v) If a person has a viral infection, then he runs a high temperature.
- (vi) If Ahmad is in Mumbai, then he is in India.
- (vii) If triangle ABC is equilateral, then all its interior angles are equal.
- (viii) If  $x$  is an irrational number, then the decimal expansion of  $x$  is non-terminating non-recurring.
- (ix) If  $x - a$  is a factor of the polynomial  $p(x)$ , then  $p(a) = 0$ .

**Solution :** Each statement above is of the form  $p \Rightarrow q$ . So, to find the converse, we first identify  $p$  and  $q$ , and then write  $q \Rightarrow p$ .

- (i)  $p$ : Jamila is riding a bicycle, and  $q$ : 17 August falls on a Sunday. Therefore, the converse is: If 17 August falls on a Sunday, then Jamila is riding a bicycle.
- (ii) This is the converse of (i). Therefore, its converse is the statement given in (i) above.
- (iii) If Pauline's face turns red, then she is angry.
- (iv) If a person is allowed to teach, then she has a degree in education.
- (v) If a person runs a high temperature, then he has a viral infection.
- (vi) If Ahmad is in India, then he is in Mumbai.
- (vii) If all the interior angles of triangle ABC are equal, then it is equilateral.
- (viii) If the decimal expansion of  $x$  is non-terminating non-recurring, then  $x$  is an irrational number.
- (ix) If  $p(a) = 0$ , then  $x - a$  is a factor of the polynomial  $p(x)$ .

Notice that we have simply written the converse of each of the statements above without worrying if they are true or false. For example, consider the following statement: If Ahmad is in Mumbai, then he is in India. This statement is true. Now consider the converse: If Ahmad is in India, then he is in Mumbai. This need not be true always – he could be in any other part of India.

In mathematics, especially in geometry, you will come across many situations where  $p \Rightarrow q$  is true, and you will have to decide if the converse, i.e.,  $q \Rightarrow p$ , is also true.

**Example 14 :** State the converses of the following statements. In each case, also decide whether the converse is true or false.

- (i) If  $n$  is an even integer, then  $2n + 1$  is an odd integer.
- (ii) If the decimal expansion of a real number is terminating, then the number is rational.
- (iii) If a transversal intersects two parallel lines, then each pair of corresponding angles is equal.
- (iv) If each pair of opposite sides of a quadrilateral is equal, then the quadrilateral is a parallelogram.
- (v) If two triangles are congruent, then their corresponding angles are equal.

**Solution :**

- (i) The converse is 'If  $2n + 1$  is an odd integer, then  $n$  is an even integer.' This is a false statement (for example,  $15 = 2(7) + 1$ , and 7 is odd).
- (ii) 'If a real number is rational, then its decimal expansion is terminating', is the converse. This is a false statement, because a rational number can also have a non-terminating recurring decimal expansion.
- (iii) The converse is 'If a transversal intersects two lines in such a way that each pair of corresponding angles are equal, then the two lines are parallel.' We have assumed, by Axiom 6.4 of your Class IX textbook, that this statement is true.
- (iv) 'If a quadrilateral is a parallelogram, then each pair of its opposite sides is equal', is the converse. This is true (Theorem 8.1, Class IX).
- (v) 'If the corresponding angles in two triangles are equal, then they are congruent', is the converse. This statement is false. We leave it to you to find suitable counter-examples.

### EXERCISE A1.5

1. Write the converses of the following statements.
  - (i) If it is hot in Tokyo, then Sharan sweats a lot.
  - (ii) If Shalini is hungry, then her stomach grumbles.
  - (iii) If Jaswant has a scholarship, then she can get a degree.
  - (iv) If a plant has flowers, then it is alive.
  - (v) If an animal is a cat, then it has a tail.

2. Write the converses of the following statements. Also, decide in each case whether the converse is true or false.
- If triangle ABC is isosceles, then its base angles are equal.
  - If an integer is odd, then its square is an odd integer.
  - If  $x^2 = 1$ , then  $x = 1$ .
  - If ABCD is a parallelogram, then AC and BD bisect each other.
  - If  $a, b$  and  $c$ , are whole numbers, then  $a + (b + c) = (a + b) + c$ .
  - If  $x$  and  $y$  are two odd numbers, then  $x + y$  is an even number.
  - If vertices of a parallelogram lie on a circle, then it is a rectangle.

### A1.7 Proof by Contradiction

So far, in all our examples, we used direct arguments to establish the truth of the results. We now explore ‘indirect’ arguments, in particular, a very powerful tool in mathematics known as ‘proof by contradiction’. We have already used this method in Chapter 1 to establish the irrationality of several numbers and also in other chapters to prove some theorems. Here, we do several more examples to illustrate the idea.

Before we proceed, let us explain what a *contradiction* is. In mathematics, a contradiction occurs when we get a statement  $p$  such that  $p$  is true and  $\sim p$ , its negation, is also true. For example,

$$p: x = \frac{a}{b}, \text{ where } a \text{ and } b \text{ are coprime.}$$

$$q: 2 \text{ divides both 'a' and 'b'.$$

If we assume that  $p$  is true and also manage to show that  $q$  is true, then we have arrived at a contradiction, because  $q$  implies that the negation of  $p$  is true. If you remember, this is exactly what happened when we tried to prove that  $\sqrt{2}$  is irrational (see Chapter 1).

How does proof by contradiction work? Let us see this through a specific example.

Suppose we are given the following :

All women are mortal. A is a woman. Prove that A is mortal.

Even though this is a rather easy example, let us see how we can prove this by contradiction.

- Let us assume that we want to establish the truth of a statement  $p$  (here we want to show that  $p$  : ‘A is mortal’ is true).

- So, we begin by assuming that the statement is not true, that is, we assume that the negation of  $p$  is true (i.e.,  $A$  is not mortal).
- We then proceed to carry out a series of logical deductions based on the truth of the negation of  $p$ . (Since  $A$  is not mortal, we have a counter-example to the statement 'All women are mortal.' Hence, it is false that all women are mortal.)
- If this leads to a contradiction, then the contradiction arises because of our faulty assumption that  $p$  is not true. (We have a contradiction, since we have shown that the statement 'All women are mortal' and its negation, 'Not all women are mortal' is true at the same time. This contradiction arose, because we assumed that  $A$  is not mortal.)
- Therefore, our assumption is wrong, i.e.,  $p$  has to be true. (So,  $A$  is mortal.)

Let us now look at examples from mathematics.

**Example 15 :** The product of a non-zero rational number and an irrational number is irrational.

**Solution :**

Statements	Analysis/Comment
We will use proof by contradiction. Let $r$ be a non-zero rational number and $x$ be an irrational number. Let $r = \frac{m}{n}$ , where $m, n$ are integers and $m \neq 0$ , $n \neq 0$ . We need to prove that $rx$ is irrational.	
Assume $rx$ is rational.	Here, we are assuming the negation of the statement that we need to prove.
Then $rx = \frac{p}{q}$ , $q \neq 0$ , where $p$ and $q$ are integers.	This follow from the previous statement and the definition of a rational number.
Rearranging the equation $rx = \frac{p}{q}$ , $q \neq 0$ , and using the fact that $r = \frac{m}{n}$ , we get $x = \frac{p}{rq} = \frac{np}{mq}$ .	

Since $np$ and $mq$ are integers and $mq \neq 0$ , $x$ is a rational number.	Using properties of integers, and definition of a rational number.
This is a contradiction, because we have shown $x$ to be rational, but by our hypothesis, we have $x$ is irrational.	This is what we were looking for — a contradiction.
The contradiction has arisen because of the faulty assumption that $rx$ is rational. Therefore, $rx$ is irrational.	Logical deduction.

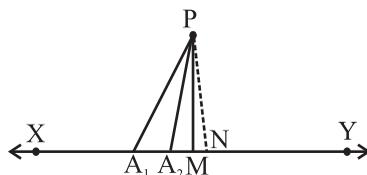
We now prove Example 11, but this time using proof by contradiction. The proof is given below:

Statements	Analysis/Comment
Let us assume that the statement is not true.	As we saw earlier, this is the starting point for an argument using 'proof by contradiction'.
So we suppose that there exists a prime number $p > 3$ , which is not of the form $6n + 1$ or $6n + 5$ , where $n$ is a whole number.	This is the negation of the statement in the result.
Using Euclid's division lemma on division by 6, and using the fact that $p$ is not of the form $6n + 1$ or $6n + 5$ , we get $p = 6n$ or $6n + 2$ or $6n + 3$ or $6n + 4$ .	Using earlier proved results.
Therefore, $p$ is divisible by either 2 or 3.	Logical deduction.
So, $p$ is not a prime.	Logical deduction.
This is a contradiction, because by our hypothesis $p$ is prime.	Precisely what we want!
The contradiction has arisen, because we assumed that there exists a prime number $p > 3$ which is not of the form $6n + 1$ or $6n + 5$ .	
Hence, every prime number greater than 3 is of the form $6n + 1$ or $6n + 5$ .	We reach the conclusion.

**Remark :** The example of the proof above shows you, yet again, that there can be several ways of proving a result.

**Theorem A1.2 :** *Out of all the line segments, drawn from a point to points of a line not passing through the point, the smallest is the perpendicular to the line.*

**Proof :**



**Fig. A1.5**

Statements	Analysis/Comment
Let XY be the given line, P a point not lying on XY and PM, PA <sub>1</sub> , PA <sub>2</sub> , . . . etc., be the line segments drawn from P to the points of the line XY, out of which PM is the smallest (see Fig. A1.5).	Since we have to prove that out of all PM, PA <sub>1</sub> , PA <sub>2</sub> , . . . etc., the smallest is perpendicular to XY, we start by taking these line segments.
Let PM be not perpendicular to XY	This is the negation of the statement to be proved by contradiction.
Draw a perpendicular PN on the line XY, shown by dotted lines in Fig. A1.5.	We often need constructions to prove our results.
PN is the smallest of all the line segments PM, PA <sub>1</sub> , PA <sub>2</sub> , . . . etc., which means $PN < PM$ .	Side of right triangle is less than the hypotenuse and known property of numbers.
This contradicts our hypothesis that PM is the smallest of all such line segments.	Precisely what we want!
Therefore, the line segment PM is perpendicular to XY.	We reach the conclusion.

**EXERCISE A1.6**

1. Suppose  $a + b = c + d$ , and  $a < c$ . Use proof by contradiction to show  $b > d$ .
2. Let  $r$  be a rational number and  $x$  be an irrational number. Use proof by contradiction to show that  $r + x$  is an irrational number.
3. Use proof by contradiction to prove that if for an integer  $a$ ,  $a^2$  is even, then so is  $a$ .  
[Hint : Assume  $a$  is not even, that is, it is of the form  $2n + 1$ , for some integer  $n$ , and then proceed.]
4. Use proof by contradiction to prove that if for an integer  $a$ ,  $a^2$  is divisible by 3, then  $a$  is divisible by 3.
5. Use proof by contradiction to show that there is no value of  $n$  for which  $6^n$  ends with the digit zero.
6. Prove by contradiction that two distinct lines in a plane cannot intersect in more than one point.

**A1.8 Summary**

In this Appendix, you have studied the following points :

1. Different ingredients of a proof and other related concepts learnt in Class IX.
2. The negation of a statement.
3. The converse of a statement.
4. Proof by contradiction.

# MATHEMATICAL MODELLING **A2**

## A2.1 Introduction

- An adult human body contains approximately 1,50,000 km of arteries and veins that carry blood.
- The human heart pumps 5 to 6 litres of blood in the body every 60 seconds.
- The temperature at the surface of the Sun is about  $6,000^{\circ}\text{C}$ .

Have you ever wondered how our scientists and mathematicians could possibly have estimated these results? Did they pull out the veins and arteries from some adult dead bodies and measure them? Did they drain out the blood to arrive at these results? Did they travel to the Sun with a thermometer to get the temperature of the Sun? Surely not. Then how did they get these figures?

Well, the answer lies in **mathematical modelling**, which we introduced to you in Class IX. Recall that a mathematical model is a mathematical description of some real-life situation. Also, recall that mathematical modelling is the process of creating a mathematical model of a problem, and using it to analyse and solve the problem.

So, in mathematical modelling, we take a real-world problem and convert it to an equivalent mathematical problem. We then solve the mathematical problem, and interpret its solution in the situation of the real-world problem. And then, it is important to see that the solution, we have obtained, 'makes sense', which is the stage of validating the model. Some examples, where mathematical modelling is of great importance, are:

- (i) Finding the width and depth of a river at an unreachable place.
- (ii) Estimating the mass of the Earth and other planets.
- (iii) Estimating the distance between Earth and any other planet.
- (iv) Predicting the arrival of the monsoon in a country.

- (v) Predicting the trend of the stock market.
- (vi) Estimating the volume of blood inside the body of a person.
- (vii) Predicting the population of a city after 10 years.
- (viii) Estimating the number of leaves in a tree.
- (ix) Estimating the ppm of different pollutants in the atmosphere of a city.
- (x) Estimating the effect of pollutants on the environment.
- (xi) Estimating the temperature on the Sun's surface.

In this chapter we shall revisit the process of mathematical modelling, and take examples from the world around us to illustrate this. In Section A2.2 we take you through all the stages of building a model. In Section A2.3, we discuss a variety of examples. In Section A2.4, we look at reasons for the importance of mathematical modelling.

A point to remember is that here we aim to make you aware of an important way in which mathematics helps to solve real-world problems. However, you need to know some more mathematics to really appreciate the power of mathematical modelling. In higher classes some examples giving this flavour will be found.

## A2.2 Stages in Mathematical Modelling

In Class IX, we considered some examples of the use of modelling. Did they give you an insight into the process and the steps involved in it? Let us quickly revisit the main steps in mathematical modelling.

**Step 1 (Understanding the problem)** : Define the real problem, and if working in a team, discuss the issues that you wish to understand. Simplify by making assumptions and ignoring certain factors so that the problem is manageable.

For example, suppose our problem is to estimate the number of fishes in a lake. It is not possible to capture each of these fishes and count them. We could possibly capture a sample and from it try and estimate the total number of fishes in the lake.

**Step 2 (Mathematical description and formulation)** : Describe, in mathematical terms, the different aspects of the problem. Some ways to describe the features mathematically, include:

- define variables
- write equations or inequalities
- gather data and organise into tables
- make graphs
- calculate probabilities

For example, having taken a sample, as stated in Step 1, how do we estimate the entire population? We would have to then mark the sampled fishes, allow them to mix with the remaining ones in the lake, again draw a sample from the lake, and see how many of the previously marked ones are present in the new sample. Then, using ratio and proportion, we can come up with an estimate of the total population. For instance, let us take a sample of 20 fishes from the lake and mark them, and then release them in the same lake, so as to mix with the remaining fishes. We then take another sample (say 50), from the mixed population and see how many are marked. So, we gather our data and analyse it.

One major assumption we are making is that the marked fishes mix uniformly with the remaining fishes, and the sample we take is a good representative of the entire population.

**Step 3 (Solving the mathematical problem) :** The simplified mathematical problem developed in Step 2 is then solved using various mathematical techniques.

For instance, suppose in the second sample in the example in Step 2, 5 fishes are marked. So,  $\frac{5}{50}$ , i.e.,  $\frac{1}{10}$ , of the population is marked. If this is typical of the whole population, then  $\frac{1}{10}$ th of the population = 20.

So, the whole population =  $20 \times 10 = 200$ .

**Step 4 (Interpreting the solution) :** The solution obtained in the previous step is now looked at, in the context of the real-life situation that we had started with in Step 1.

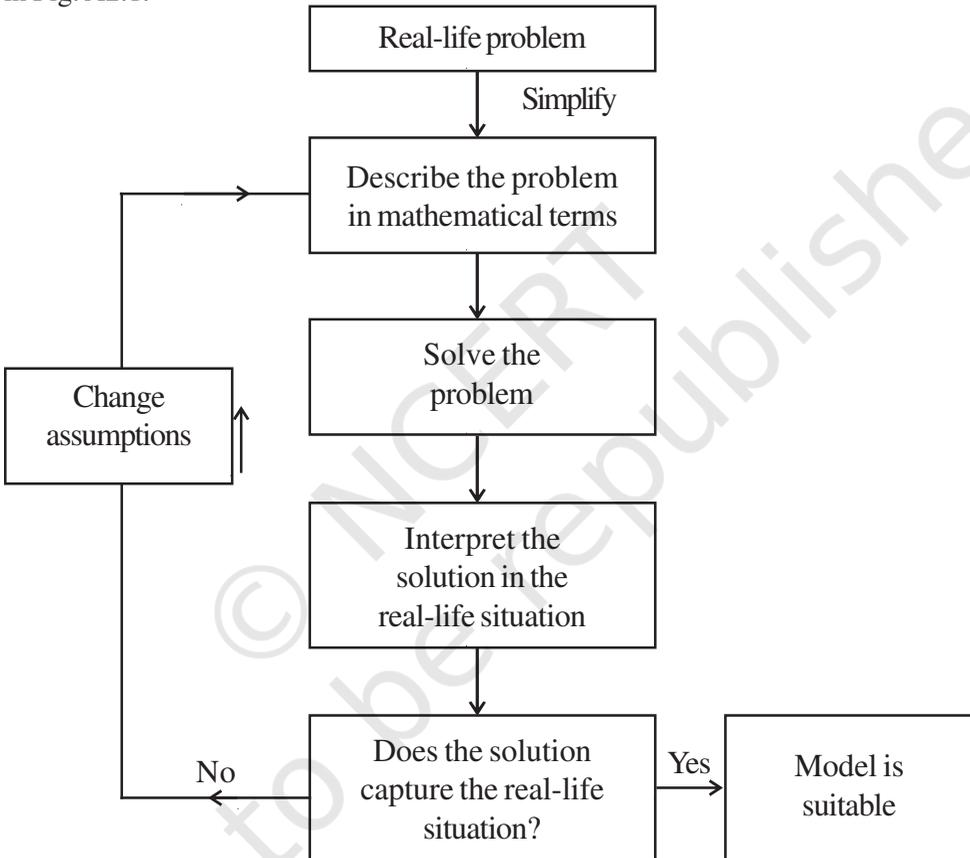
For instance, our solution in the problem in Step 3 gives us the population of fishes as 200.

**Step 5 (Validating the model) :** We go back to the original situation and see if the results of the mathematical work make sense. If so, we use the model until new information becomes available or assumptions change.

Sometimes, because of the simplification assumptions we make, we may lose essential aspects of the real problem while giving its mathematical description. In such cases, the solution could very often be off the mark, and not make sense in the real situation. If this happens, we reconsider the assumptions made in Step 1 and revise them to be more realistic, possibly by including some factors which were not considered earlier.

For instance, in Step 3 we had obtained an estimate of the entire population of fishes. It may not be the actual number of fishes in the pond. We next see whether this is a good estimate of the population by repeating Steps 2 and 3 a few times, and taking the mean of the results obtained. This would give a closer estimate of the population.

Another way of visualising **the process of mathematical modelling** is shown in Fig. A2.1.



**Fig. A2.1**

Modellers look for a balance between simplification (for ease of solution) and accuracy. They hope to approximate reality closely enough to make some progress. The best outcome is to be able to predict what will happen, or estimate an outcome, with reasonable accuracy. Remember that different assumptions we use for simplifying the problem can lead to different models. So, there are no perfect models. There are good ones and yet better ones.

### EXERCISE A2.1

1. Consider the following situation.

*A problem dating back to the early 13th century, posed by Leonardo Fibonacci asks how many rabbits you would have if you started with just two and let them reproduce. Assume that a pair of rabbits produces a pair of offspring each month and that each pair of rabbits produces their first offspring at the age of 2 months. Month by month the number of pairs of rabbits is given by the sum of the rabbits in the two preceding months, except for the 0th and the 1st months.*

Month	Pairs of Rabbits
0	1
1	1
2	2
3	3
4	5
5	8
6	13
7	21
8	34
9	55
10	89
11	144
12	233
13	377
14	610
15	987
16	1597

*After just 16 months, you have nearly 1600 pairs of rabbits!*

Clearly state the problem and the different stages of mathematical modelling in this situation.

### A2.3 Some Illustrations

Let us now consider some examples of mathematical modelling.

**Example 1 (Rolling of a pair of dice) :** Suppose your teacher challenges you to the following guessing game: She would throw a pair of dice. Before that you need to guess the sum of the numbers that show up on the dice. For every correct answer, you get two points and for every wrong guess you lose two points. What numbers would be the best guess?

**Solution :**

**Step 1 (Understanding the problem) :** You need to know a few numbers which have higher chances of showing up.

**Step 2 (Mathematical description) :** In mathematical terms, the problem translates to finding out the probabilities of the various possible sums of numbers that the dice could show.

We can model the situation very simply by representing a roll of the dice as a random choice of one of the following thirty six pairs of numbers.

(1, 1)	(1, 2)	(1, 3)	(1, 4)	(1, 5)	(1, 6)
(2, 1)	(2, 2)	(2, 3)	(2, 4)	(2, 5)	(2, 6)
(3, 1)	(3, 2)	(3, 3)	(3, 4)	(3, 5)	(3, 6)
(4, 1)	(4, 2)	(4, 3)	(4, 4)	(4, 5)	(4, 6)
(5, 1)	(5, 2)	(5, 3)	(5, 4)	(5, 5)	(5, 6)
(6, 1)	(6, 2)	(6, 3)	(6, 4)	(6, 5)	(6, 6)

The first number in each pair represents the number showing on the first die, and the second number is the number showing on the second die.

**Step 3 (Solving the mathematical problem) :** Summing the numbers in each pair above, we find that possible sums are 2, 3, 4, 5, 6, 7, 8, 9, 10, 11 and 12. We have to find the probability for each of them, assuming all 36 pairs are equally likely.

We do this in the following table.

<b>Sum</b>	2	3	4	5	6	7	8	9	10	11	12
<b>Probability</b>	$\frac{1}{36}$	$\frac{2}{36}$	$\frac{3}{36}$	$\frac{4}{36}$	$\frac{5}{36}$	$\frac{6}{36}$	$\frac{5}{36}$	$\frac{4}{36}$	$\frac{3}{36}$	$\frac{2}{36}$	$\frac{1}{36}$

Observe that the chance of getting a sum of a seven is  $\frac{1}{6}$ , which is larger than the chances of getting other numbers as sums.

**Step 4 (Interpreting the solution) :** Since the probability of getting the sum 7 is the highest, you should repeatedly guess the number seven.

**Step 5 (Validating the model) :** Toss a pair of dice a large number of times and prepare a relative frequency table. Compare the relative frequencies with the corresponding probabilities. If these are not close, then possibly the dice are biased. Then, we could obtain data to evaluate the number towards which the bias is.

Before going to the next example, you may need some background.

Not having the money you want when you need it, is a common experience for many people. Whether it is having enough money for buying essentials for daily living, or for buying comforts, we always require money. To enable the customers with limited funds to purchase goods like scooters, refrigerators, televisions, cars, etc., a scheme known as an *instalment scheme (or plan)* is introduced by traders.

Sometimes a trader introduces an *instalment* scheme as a marketing strategy to allure customers to purchase these articles. Under the instalment scheme, the customer is not required to make full payment of the article at the time of buying it. She/he is allowed to pay a part of it at the time of purchase, and the rest can be paid in instalments, which could be monthly, quarterly, half-yearly, or even yearly. Of course, the buyer will have to pay more in the instalment plan, because the seller is going to charge some interest on account of the payment made at a later date (called *deferred payment*).

Before we take a few examples to understand the instalment scheme, let us understand the most frequently used terms related to this concept.

The *cash price* of an article is the amount which a customer has to pay as full payment of the article at the time it is purchased. *Cash down payment* is the amount which a customer has to pay as part payment of the price of an article at the time of purchase.

**Remark :** If the instalment scheme is such that the remaining payment is completely made within one year of the purchase of the article, then simple interest is charged on the deferred payment.

In the past, charging interest on borrowed money was often considered evil, and, in particular, was long prohibited. One way people got around the law against paying interest was to borrow in one currency and repay in another, the interest being disguised in the exchange rate.

Let us now come to a related mathematical modelling problem.

**Example 2 :** Juhi wants to buy a bicycle. She goes to the market and finds that the bicycle she likes is available for ₹ 1800. Juhi has ₹ 600 with her. So, she tells the shopkeeper that she would not be able to buy it. The shopkeeper, after a bit of calculation, makes the following offer. He tells Juhi that she could take the bicycle by making a payment of ₹ 600 cash down and the remaining money could be made in two monthly instalments of ₹ 610 each. Juhi has two options one is to go for instalment scheme or to make cash payment by taking loan from a bank which is available at the rate of 10% per annum simple interest. Which option is more economical to her?

**Solution :**

**Step 1 (Understanding the problem) :** What Juhi needs to determine is whether she should take the offer made by the shopkeeper or not. For this, she should know the two rates of interest—one charged in the instalment scheme and the other charged by the bank (i.e., 10%).

**Step 2 (Mathematical description) :** In order to accept or reject the scheme, she needs to determine the interest that the shopkeeper is charging in comparison to the bank. Observe that since the entire money shall be paid in less than a year, simple interest shall be charged.

We know that the cash price of the bicycle = ₹ 1800.

Also, the cashdown payment under the instalment scheme = ₹ 600.

So, the balance price that needs to be paid in the instalment scheme = ₹ (1800 – 600) = ₹ 1200.

Let  $r$  % per annum be the rate of interest charged by the shopkeeper.

Amount of each instalment = ₹ 610

Amount paid in instalments = ₹ 610 + ₹ 610 = ₹ 1220

Interest paid in instalment scheme = ₹ 1220 – ₹ 1200 = ₹ 20 (1)

Since, Juhi kept a sum of ₹ 1200 for one month, therefore,

Principal for the first month = ₹ 1200

Principal for the second month = ₹ (1200 – 610) = ₹ 590

Balance of the second principal ₹ 590 + interest charged (₹ 20) = monthly instalment (₹ 610) = 2nd instalment

So, the total principal for one month = ₹ 1200 + ₹ 590 = ₹ 1790

Now, 
$$\text{interest} = ₹ \frac{1790 \times r \times 1}{100 \times 12} \quad (2)$$

**Step 3 (Solving the problem) :** From (1) and (2)

$$\frac{1790 \times r \times 1}{100 \times 12} = 20$$

or 
$$r = \frac{20 \times 1200}{1790} = 13.14 \text{ (approx.)}$$

**Step 4 (Interpreting the solution) :** The rate of interest charged in the instalment scheme = 13.14 %.

The rate of interest charged by the bank = 10%

So, she should prefer to borrow the money from the bank to buy the bicycle which is more economical.

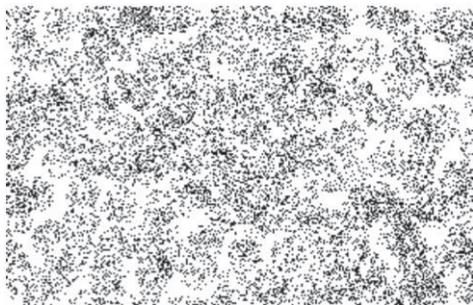
**Step 5 (Validating the model) :** This stage in this case is not of much importance here as the numbers are fixed. However, if the formalities for taking loan from the bank such as cost of stamp paper, etc., which make the effective interest rate more than what it is the instalment scheme, then she may change her opinion.

**Remark :** Interest rate modelling is still at its early stages and validation is still a problem of financial markets. In case, different interest rates are incorporated in fixing instalments, validation becomes an important problem.

## EXERCISE A.2.2

In each of the problems below, show the different stages of mathematical modelling for solving the problems.

- An ornithologist wants to estimate the number of parrots in a large field. She uses a net to catch some, and catches 32 parrots, which she rings and sets free. The following week she manages to net 40 parrots, of which 8 are ringed.
  - What fraction of her second catch is ringed?
  - Find an estimate of the total number of parrots in the field.
- Suppose the adjoining figure represents an aerial photograph of a forest with each dot representing a tree. Your purpose is to find the number of trees there are on this tract of land as part of an environmental census.



3. A T.V. can be purchased for ₹ 24000 cash or for ₹ 8000 cashdown payment and six monthly instalments of ₹ 2800 each. Ali goes to market to buy a T.V., and he has ₹ 8000 with him. He has now two options. One is to buy TV under instalment scheme or to make cash payment by taking loan from some financial society. The society charges simple interest at the rate of 18% per annum simple interest. Which option is better for Ali?

## A2.4 Why is Mathematical Modelling Important?

As we have seen in the examples, mathematical modelling is an interdisciplinary subject. Mathematicians and specialists in other fields share their knowledge and expertise to improve existing products, develop better ones, or predict the behaviour of certain products.

There are, of course, many specific reasons for the importance of modelling, but most are related in some ways to the following :

- *To gain understanding.* If we have a mathematical model which reflects the essential behaviour of a real-world system of interest, we can understand that system better through an analysis of the model. Furthermore, in the process of building the model we find out which factors are most important in the system, and how the different aspects of the system are related.
- *To predict, or forecast, or simulate.* Very often, we wish to know what a real-world system will do in the future, but it is expensive, impractical or impossible to experiment directly with the system. For example, in weather prediction, to study drug efficacy in humans, finding an optimum design of a nuclear reactor, and so on.

Forecasting is very important in many types of organisations, since predictions of future events have to be incorporated into the decision-making process. For example:

In marketing departments, reliable forecasts of demand help in planning of the sale strategies.

A school board needs to be able to forecast the increase in the number of school going children in various districts so as to decide where and when to start new schools.

Most often, forecasters use the past data to predict the future. They first analyse the data in order to identify a pattern that can describe it. Then this data and pattern is extended into the future in order to prepare a forecast. This basic strategy is employed in most forecasting techniques, and is based on the assumption that the pattern that has been identified will continue in the future also.

- *To estimate.* Often, we need to estimate large values. You've seen examples of the trees in a forest, fish in a lake, etc. For another example, before elections, the contesting parties want to predict the probability of their party winning the elections. In particular, they want to estimate how many people in their constituency would vote for their party. Based on their predictions, they may want to decide on the campaign strategy. Exit polls have been used widely to predict the number of seats, a party is expected to get in elections.

### EXERCISE A2.3

1. Based upon the data of the past five years, try and forecast the average percentage of marks in Mathematics that your school would obtain in the Class X board examination at the end of the year.

### A2.5 Summary

In this Appendix, you have studied the following points :

1. A mathematical model is a mathematical description of a real-life situation. Mathematical modelling is the process of creating a mathematical model, solving it and using it to understand the real-life problem.
2. The various steps involved in modelling are : understanding the problem, formulating the mathematical model, solving it, interpreting it in the real-life situation, and, most importantly, validating the model.
3. Developed some mathematical models.
4. The importance of mathematical modelling.